



ÜRÜN KATALOĐU  
PRODUCT CATALOGUE

2022

39 YIL  
Since 1983

ÇOK YAKINDA  
**COMING  
SOON**

 **Mutlusan®**  
electric

## YENİ MODÜLER SİSTEM SERİMİZ

Farklı Kombinasyonlar  
Şık ve Ergonomik Tasarım ile  
**YAKINDA...**

## OUR NEW MODULAR SYSTEM SERIES

Coming soon !  
with different combinations,  
stylish and ergonomic design.





39

YIL - YEARS  
SINCE 1983

# İÇİNDEKİLER INDEX



06

**ANAHTAR PRİZ GRUBU**  
SWITCHES & SOCKETS GROUP



58

**KABLO KANALLARI**  
CABLE TRUNKING



125

**ABS PLASTİK PANOLAR**  
ABS PLASTIC PANELS



138

**TESİSAT MALZEMELERİ**  
INSTALLATION MATERIALS



184

**SANAYİ ÜRÜN GRUBU**  
INDUSTRIAL PRODUCT GROUP



232

**AYDINLATMA GRUBU**  
LIGHTING GROUP

**RITA SERİSİ**  
**ELITRA PLUS SERİSİ**  
**CANDELA SERİSİ**  
**NEMLİYER (SIVA ÜSTÜ)**  
**BRON (SIVA ÜSTÜ)**  
**GRUP PRİZLER**  
**AKSESUARLAR**

**RITA SERIES**  
**ELITRA PLUS SERIES**  
**CANDELA SERIES**  
**NEMLİYER (SURFACE)**  
**BRON (SURFACE)**  
**GROUP SOCKETS**  
**ACCESSORIES**

**HALOGEN FREE KABLO KANALI**  
**KENDİNDEN KAPAKLI KANALLAR**  
**DIŞTAN KAPAKLI KANALLAR**  
**MEKS 100'LÜK SERİ PRİZ MONTAJ SETLERİ**  
**MEKSPLUS SERİSİ İÇTEN KAPAKLI KANALLAR**  
**SÜPÜRGELİK KABLO KANALLARI**  
**ZEMİN KABLO KANALLARI**  
**PROFİLLER**  
**KLİMA KANALI**  
**SIDEM SERİSİ KABLO KANALLAR**  
**HALOGEN FREE DELİKLİ KABLO KANALI**  
**DELİKLİ KABLO KANALI**

**HALOGEN FREE CABLE TRUNKING**  
**CABLE TRUNKING WITH INTRINSIC COVER**  
**CABLE TRUNKING WITH EXTERNAL COVER**  
**MEKS 100 SERIES PLUG SOCKET ASSEMBLY SETS**  
**MEKSPLUS SERIES INTERNAL COVER CABLE TRUNKING**  
**SKIRTING BOARD CABLE TRUNKING**  
**FLOOR CABLE TRUNKING**  
**PROFILES**  
**AIR CONDITIONING TRUNKING**  
**SIDEM SERIES CABLE TRUNKING**  
**HALOGEN FREE PERFORATED CABLE TRUNKING**  
**PERFORATED CABLE TRUNKING**

**ABS PLASTİK OPAK KAPAKLI PANOLAR**  
**ABS PLASTİK TRANSPARAN KAPAKLI PANOLAR**  
**PANO AKSESUARLARI**  
**PANO PRİZİ**  
**TERMOSTAT VE HİGROSTATLAR**  
**FANLAR VE FİLTRELER**  
**KABLO BAĞLARI VE KROŞELER**

**ABS PLASTIC PANELS WITH OPAQUE LID**  
**ABS PLASTIC PANELS WITH TRANSPARENT LID**  
**PANEL ACCESSORIES**  
**RAIL TYPE PANEL SOCKET**  
**THERMOSTAT AND HYGROSTAT**  
**FANS AND FILTERS**  
**CABLE TIES AND CROCHETS**

**COMFORT SİGORTA VE ZAYIF AKIM KUTULARI**  
**W OTOMAT KUTULARI**  
**TELEFON DAĞITIM KUTULARI VE AKSESUARLARI**  
**MODÜL BAĞLANTI ÇATISI**  
**ÇELİK SİRALLER PVC SİRALLER VE BORULAR**  
**HALOGEN FREE SİRALLER**  
**SİBOR SERİSİ BORULAR**  
**SUSTALAR VE BUAT KAPAKLARI**  
**BETON DUVAR KASALARI**  
**PLASTİK KASA VE BUATLAR**  
**KROŞELER**  
**PLASTİK DÜBELLER**

**COMFORT FUSE AND LOW-CURRENT BOXES**  
**FUSE BOXES**  
**TELEPHONE DISTRIBUTION BOXES (HUBS) and ACCESSORIES**  
**MODULE CONNECTION RACK**  
**STEEL SPIRALS PVC SPIRALS AND PIPES**  
**HALOGEN-FREE SPIRALS**  
**SİBOR SERIES PIPES**  
**CABLE PULLERS AND JUNCTION BOX COVERS**  
**CONCRETE WALL CASINGS**  
**PLASTIC CASINGS AND JUNCTION BOXES**  
**CABLE STRAPS**  
**PLASTIC DOWELS**

**SANAYİ FİŞ - PRİZ GRUBU**  
**SİNYAL VE KUMANDA BUTONLARI**  
**ETANJ BUTON KUTULARI**  
**VİNÇ KUMANDA BUTONLARI**  
**SÜPER ETANJ RAKORLAR**  
**RAY KLEMENSLER**  
**SIKMALI TİP KABLO PAPUÇLARI**  
**SIRA KLEMENSLER**  
**RAYLAR TOPRAKLAMA ÇUBUĞU VE BARALAR**  
**TERMOPLASTİK BUATLAR**

**PLUG - SOCKET GROUP**  
**SIGNAL AND CONTROL BUTTONS**  
**WATERPROOF BUTTON BOXES**  
**CRANE CONTROL BUTTONS**  
**SUPER WATERPROOF CABLE GLANDS**  
**RAIL TERMINAL BLOCKS**  
**CLAMPING TYPE CABLE TERMINAL LUGS**  
**CONNECTOR (TERMINAL BLOCKS)**  
**RAILS, GROUNDING ROD AND BUSBARS**  
**THERMOPLASTIC JUNCTION BOXES**

**TAVAN ARMATÜRLERİ**  
**DUVAR ARMATÜRLERİ**  
**BAHÇE AYDINLATMA**  
**ACİL DURUM ARMATÜRLERİ**

**CEILING LIGHTING FIXTURE**  
**WALL LIGHTING FIXTURE**  
**GARDEN LIGHTING**  
**EMERGENCY LIGHTING**



**Mustafa KAÇMAZ**  
Yönetim Kurulu Başkanı  
Chairman of the Executive Board / CEO

Değerli Dostlarımız;

Endüstriyel hikayemiz, 1983 yılında Karaköy mağazamızda, sektöre ve ülkemize duyduğumuz güvenle başladı. Dönemin zor koşullarına rağmen, Mutlusan'ın geleceğine inandık. Koşullar nedeniyle kısıtlı miktarda başlattığımız üretim ve bunu takip eden uzun dönemdeki sabırlı çalışmalarımız ile günümüzde ortaya çıkan büyük Mutlusan ailemizin tohumlarını attık.

Mutlusan ailesi olarak, zorlukları aşmak, yenilikçilik, dürüst ve işinin ehli üreticilik, tüketiciye ve müşterilerimize saygı, yatırım tutkusu gibi konularda ilk günkü heyecanla bugün de devam ediyoruz.

Son yıllarda hızlı bir değişim ve büyüme süreci yaşıyoruz. Yeni yatırımlar, teknolojik yenilenme, kurumsallaşma çalışmaları, yeniden yapılanma, yeni pazarlar ve yeni ürünlerle gelişimimizi sürekli hale getirmeye çalışıyoruz. Şirketimizde durmaksızın büyüme imkânları araştırılarak, verimliliğin artırılmasına yönelik planlamalar yapılıyor. Yenilikçilik desteklenerek, teknolojik altyapı güçlendiriliyor ve insan kaynaklarımızı zenginleştiriyoruz.

Geleneksel değerlerimizi koruyarak değişen dünyaya ayak uydurma başarısını sürekli kılmayı hedefliyoruz.

Küreselleşme sayesinde şirketler, ülkelerinden kilometrelerce uzaktaki, tüketicilere yanı başlarındaymiş gibi ulaşabiliyor.

Ürünlerimizde milyonlarca kilometre ötedeki insanlara ulaşarak, onların yaşamlarına değer katmak için çalışıyoruz. Bu bize, Türkiye markası olarak sadece ülkemizi değil, dünyayı da anlamak zorunda olduğumuz mesajını veriyor.

Bu mesaj bize değişim sürecimizi, hem Türkiye hem de dünyadaki ekonomi ve endüstriyel enerji/elektrik sektöründeki gelişmeleri yakından izleyerek yönetmemiz gerektiğini söylüyor.

Mutlusan ailesi olarak, sosyal sorumluluk anlayışımız, eğitim, spor, çevre, sağlık konularındaki gelişme ve iyileşmeleri teşvik eden bir yaklaşımdır. Bu konularda, ilgili sivil toplum kuruluşlarıyla çalışmalarımız devam edecektir.

1983 yılında, bu ülkenin geleceğine güvenerek çıktığımız bu yolda zaman bizleri haklı çıkardı. Bugün 40.000 metre-karelik üretim tesisi ve 600 kişilik çalışan kadromuzla birlikte, bu ülkede doğmuş bir markayı yöneten bizler, hem Türkiye'nin hem de Mutlusan'ın dünyadaki geleceğine inanıyor ve buna güveniyoruz.

Her zaman söylediğimiz ve hayat felsefemiz olan cümleyi tekrar etmek isterim.

“Biz, Çalışırken Mutluyuz...”

Dear Friends,

Our industrial story began with confidence in the sector and our country in our Karaköy Store in 1983. Despite the difficult circumstances, we believed in the future of Mutlusan. We have sowed the seeds of our great Mutlusan family that emerged today with production we started in limited quantities due to the circumstances and our long-term patience.

As the Mutlusan Family, we continue today with the first day's excitement about overcoming challenges, innovating, honest and responsible production, respect for our customers and investment passion.

In recent years we are experiencing a rapid change and growth process. We are trying to make our investments with new investments, technological renewal, institutionalization studies, restructuring, new markets and new products. Our company is constantly searching for growth opportunities and planning to increase its productivity. By supporting innovation, we are strengthening our technological infrastructure and enriching our human resources.

We aim to keep the success of the changing world by sustaining our traditional values.

Thanks to globalization, companies are able to reach their customers as if they were close to customers who are kilometers away.

Reaching out to people thousands of kilometers away in our products, we strive to add value to their lives. This situation get the message to us, We as a Turkey brand have to understand the world as well not only our country.

This message says us; we need to manage our change process by watching closely developments in the both Turkey and the world economic and industrial Energy/ Electricity sector.

As a Mutlusan Family, social responsibility is an approach that promotes improvements and improve-ments in education, sport, environment, health issues. In these matters, we will continue to work with the relevant civil society organizations.

In 1983, we were justified in this way when we came to rely on the future of this country. Today we manage a brand that is born in this country with a 40,000 square meter production facility and 600 employees and believe both Turkey's and the Mutlusan future of the world.

We always say, and I would like to repeat the sentence which is our life philosophy.

"We are Happy at Work"





Rita

Elitra Plus

Candela

Nemliyer • Wet Ground

Bron





**ANAHTAR PRİZ GRUBU**  
SWITCHES & SOCKETS GROUP

# ANAHTAR MEKANİZMA

## MECHANISM SWITCHES

Mükemmel tasarımı dış görünümü ve yenilenen iç mekanizması ile

### KUSURSUZ ...

With its perfectly designed exterior and renewed interior mechanics

### PERFECT...



Klipsli Mekanizma  
Easy Connection  
Mechanism



Vidalı Mekanizma  
Mechanism with  
screw

Çocuk Korumasız Prizlerinizin Çözümü  
Child protection is provided with  
the help of this apparatus



IP44 Kapaklı Priz Conta ile  
daha güvende..

Safer with IP44 insulating frame

## Rita

SERİSİ / SERIES

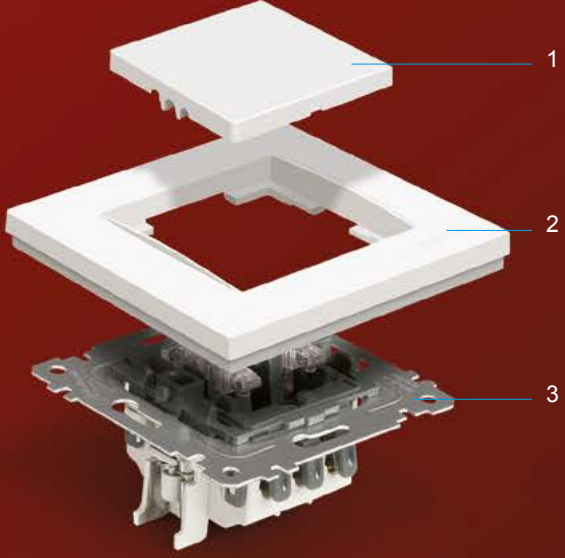

- 1 - Tuş / Plate
- 2- Çerçeve / Frame
- 3- Mekanizma / Mechanizm

## Elitra Plus

SERİSİ / SERIES

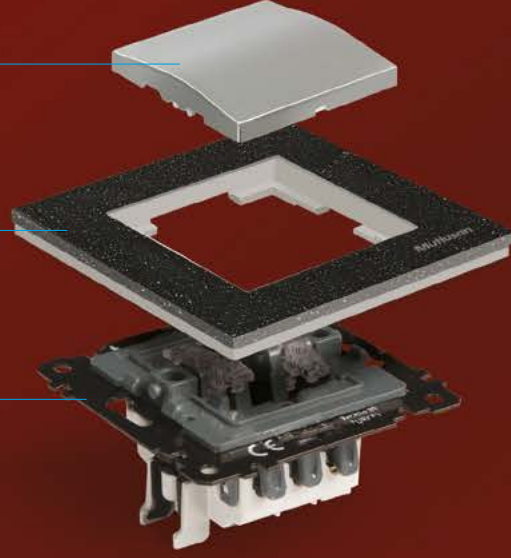

- 1 - Tuş / Plate
- 2- Çerçeve / Frame
- 3- Mekanizma / Mechanizm

## Candela

SERİSİ / SERIES

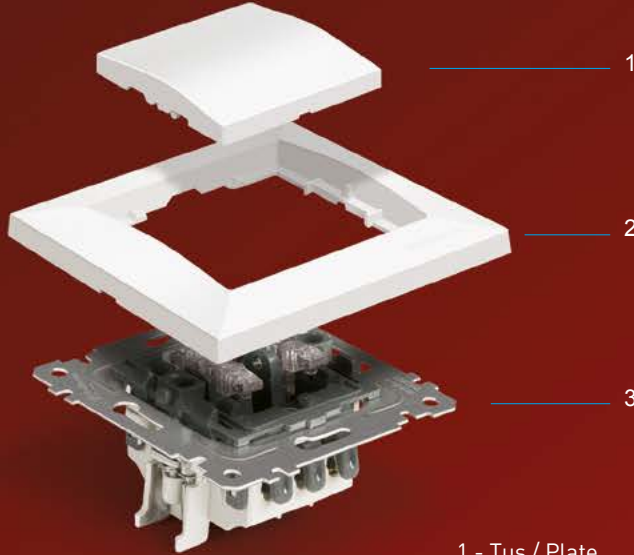

- 1 - Tuş / Plate
- 2- Çerçeve / Frame
- 3- Mekanizma / Mechanizm



## Akılcı  z mler...

Teknolojik  r nleri ince detaylı tasarımlarla hayatınıza kattık, size keyfini  ıkarmak kaldı.

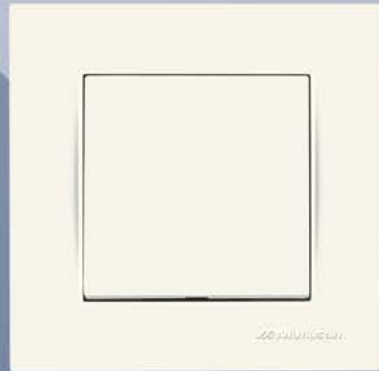



## Rational solutions ...

We bring Technological products with fine detail design to your life, it's up to you to enjoy.





## Yeniliklerin m jdecisi...

Artık daha teknolojik bir hayat var...  
Rita serisi yenilikçi  r nleri ile hayatınızı kolaylařtırmak i in  
yanıbařınızda...





## The herald of innovation ...

Now there are more technological life ...  
The Rita series is at your side to make your life easier with  
innovative products ...



**ANAHTAR GRUBU  
VİDALI TİP  
SWITCH GROUP  
(WITH SCREW)**



2220 401 02XX  
Anahatar  
Oneq. One Way Switch



2220 402 02XX  
Komütatör  
Twoq. One Way Control



2220 403 02XX  
Vavien (iki Yollu Anahtar)  
Oneq. Two Way Switch

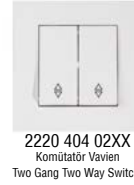

2220 404 02XX  
Komütatör Vavien  
Two Gang Two Way Switch



2220 405 02XX  
Çift Kutuplu Anahtar  
Oneq. One Way Dp



2220 406 02XX  
Jalu Anahtar  
Blind Switch -W/Spring



2220 407 02XX  
Çağırma  
One Gang One Way Control



2220 407 02XXX  
Kapı Otomatijli Anahtar  
Door Switch



2220 407 02XXZ  
Zil Anahtar  
Ring Switch



2220 408 02XX  
Deviyatör(Ara Vavien)  
Oneq. Intermediate-Deviyatör



2220 409 02XX  
Üçlü Anahtar  
3 Gang Switch



2220 411 02XX  
Şofben Anahtar  
Heater Switch



2220 415 02XX  
Işıklı Anahtar (220V)  
Illu.1q.1w.Swi. (220v)



2220 416 02XX  
Işıklı Vavien (220V)  
Illu.Oneq. Two Way (220v)



2220 417 02XX  
Işıklı Çağırma (220V)  
Illu.1q.1w.Cntrl (220v)



2220 418 02XX  
Işıklı Etik Anahtar (220V)  
Illu.1q.1w.W/Lab. (220v)



2220 419 02XX  
Işıklı Etik Çağırma (220V)  
I.1q.1w.Cntrl/Lab. (220v)



2220 422 02XX  
Işıklı Zil Etik Çağırma (12v)  
Illu.1q.1w.Cntrl (12v)



2220 425 02XX  
Tek Tuşlu Jalu Anahtar  
(Vidalı)  
Blind Switch (With Screw)



2220 426 02XX  
Işıklı Komütatör  
Illu. Twoq. One Way Switch



2220 436 02XX  
Jalu Anahtar (Yaysız - Vidalı)  
Blind Switch (With Screw)

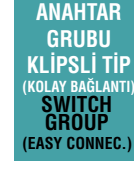

2220 401 01XX  
Anahatar  
Oneq. One Way Switch



2220 402 01XX  
Komütatör  
Twoq. One Way Control



2220 403 01XX  
Vavien (iki Yollu Anahtar)  
Oneq. Two Way Switch



2220 404 01XX  
Komütatör Vavien  
Two Gang Two Way Switch



2220 405 01XX  
Çift Kutuplu Anahtar  
Oneq. One Way Dp



2220 406 01XX  
Jalu Anahtar  
Blind Switch -W/Spring



2220 407 01XX  
Çağırma  
One Gang One Way Control



2220 407 01XXX  
Kapı Otomatijli Anahtar  
Door Switch



2220 407 01XXZ  
Zil Anahtar  
Ring Switch



2220 408 01XX  
Deviyatör(Ara Vavien)  
Oneq. Intermediate-Deviyatör



2220 409 01XX  
Üçlü Anahtar  
3 Gang Switch



2220 415 01XX  
Işıklı Anahtar (220V)  
Illu.1q.1w.Swi. (220v)

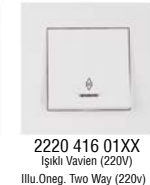

2220 416 01XX  
Işıklı Vavien (220V)  
Illu.Oneq. Two Way (220v)

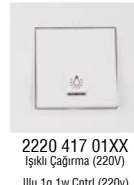

2220 417 01XX  
Işıklı Çağırma (220v)  
Illu.1q.1w.Cntrl (220v)



2220 418 01XX  
Işıklı Etik Anahtar (220V)  
Illu.1q.1w.W/Lab. (220v)



2220 419 01XX  
Işıklı Etik Çağırma (220V)  
I.1q.1w.Cntrl/Lab. (220v)



2220 422 01XX  
Işıklı Zil Etik Çağırma (12v)  
Illu.1q.1w.Cntrl (12v)



2220 426 01XX  
Işıklı Komütatör  
Illu. Twoq. One Way Switch



2220 436 01XX  
Jalu Anahtar (Yaysız -Klipsli)  
Blind Switch (Without Screw)



**DİMMER GRUBU  
DIMMER GROUP**

2220 440 02XX  
RL Işıklı Dimmer 600W  
Rotary Dimmer 600W



2220 444 02XX  
RL Işıklı Dimmer 1000W  
Rotary Dimmer 1000W



2220 447 02XX  
Meks+Tuş RC Dimmer 325W  
RC Dimmer 325W



**ELEKTRONİK GRUBU  
ELECTRONICS GROUP**

2220 450 01XX  
Energy Saver G.sız Işıklı  
Energy Saver Not Delay Illu.



2220 452 01XX  
Energy Saver Gecikmeli Işıklı  
Energy Saver Delay Illu.



2220 470 02XX  
Müzik Yayın Anahtar  
Audio Switch



2220 480 01XX  
Hoparlör Prizi  
Speaker Socket



2220 485 02XX  
Uyarı Zili  
Warning Bell



2220 495 02XX  
Hareket Sensörü  
Motion Sensor

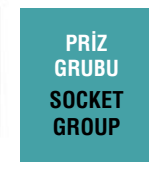

**PRİZ GRUBU  
SOCKET GROUP**

2220 600 02XX  
Topraklı Priz  
Earthed Socket



2220 601 02XX  
Topraksız Priz  
Non Earthed Socket



2220 605 02XX  
Topraklı Priz (Çocuk Kor.)  
Earthed Socket (Child Prot.)



2220 606 02XX  
Topraksız Priz (Çocuk Kor.)  
Non Earth. Soc. (Child Prot.)



2220 610 02XX  
Kapaklı Topraklı Priz  
Earthed Socket With Cover



2220 611 02XX  
Kapaklı Topraklı Priz (Çoc. Kor.)  
Earthed Soc. Cover (Child Prot.)



2220 615 02XX  
Ups (Fransız) Prizi  
Ups (French) Socket (Earthed)



2220 616 02XX  
Ups (Fransız) Prizi (Çoc. Kor.)  
Ups (French) Soc.Child Prot.



2220 617 02XX  
Ups Kapaklı (Fransız) Priz  
Ups (French) Soc. With Cover



2220 618 02XX  
Ups Kapaklı (Fr.) Priz (Çoc. Kor.)  
Ups (French) Soc.W.Cover (C.P.)



2220 448 01XX  
Tekli Usb Şarj Prizi  
1\*Usb Charger



2220 449 01XX  
İkili Usb Şarj Prizi  
2\*Usb Charger



2220 200 02XX  
İkili Topraklı Priz Porselen  
Double Socket Earthed Porcelain



2220 201 02XX  
İkili Topraksız Priz Porselen  
Double Soc.Non Earthed Porcelain



2220 202 02XX  
İkili Topraklı Priz  
Double Socket Earthed



2220 203 02XX  
İkili Topraksız Priz  
Double Soc.Non Earthed





**2220 215 02XX**  
İkili Ups Priz  
Double Socket Ups



**2220 619 02XX**  
İkili Usb (2,4A) Topraklı Priz  
2\*Usb ( 2,4A) Earthed Socket

### İLETİŞİM GRUBU COMMUNICATION GROUP



**2220 125 01XX**  
Telefon Priz 1Xrj12 (Cat3)  
Phonesocket 1\*Rj12 (Cat3)



**2220 126 01XX**  
Telefon Priz 2Xrj12 (Cat3)  
Telephone Soc.2xrj12



**2220 128 01XX**  
Etiketli Tlf Data Priz (Kon.süz)  
Tlf Data Soc.W/O Con. Label



**2220 135 02XX**  
Data Priz 1\*Rj45 (Kon.süz)  
Data Soc.1\*Rj45w/Ocon.



**2220 136 01XX**  
Data Priz 1\*Rj45 (Cat5e)  
Data Soc.1\*Rj45 (Cat5e)



**2220 137 01XX**  
Data Priz 2\*Rj45 (Kon.süz)  
Data Soc.2\*Rj45w/Ocon.



**2220 138 01XX**  
Data Priz 2\*Rj45 (Cat5e)  
Data Soc.2\*Rj45 (Cat5e)



**2220 139 01XX**  
Tlf Data Priz (Rj12 Cat3 + Cat5e)  
Tlf Data Soc.(Rj12 Cat5e)



**2220 140 01XX**  
Data Priz 1\*Rj45 (Cat6)  
Data Soc.1\*Rj45 (Cat6)



**2220 141 01XX**  
Data Priz 2\*Rj45 (Cat6)  
Data Soc.2\*Rj45 (Cat6)



**2220 455 01XX**  
Data Priz 1\*Usb  
Data Soc.1\*Usb



**2220 456 01XX**  
Data Priz 2\*Usb  
Data Soc.2\*Usb



**2220 457 01XX**  
Data Priz 1\*Hdmi  
Data Soc.1\*Hdmi



**2220 458 01XX**  
Data Priz 2\*Hdmi  
Data Soc.2\*Hdmi



**2220 459 01XX**  
Data Priz 1\*Usb/1\*Hdmi  
Data Soc.1\*Usb/1\*Hdmi



**2220 460 01XX**  
VGA Priz  
Switch Vga Socket



**2220 461 01XX**  
İki Çıkışlı Fiber Optik Priz  
İki Çıkışlı Fiber Optik Priz



**2220 121 02XX**  
Kör Kapak  
Blind Cover White

### TV / SAT GRUBU TV / SAT GROUP



**2220 156 02XX**  
Tv-Sat Priz (Geçişli) 4Db/Fcon.  
Tv-Sat Soc.Thr.4db/Fcon.



**2220 157 02XX**  
Tv-Sat Priz (Sonlu)  
Tv-Sat Soc.(Dead End)



**2220 166 01XX**  
Sat Priz (Geçişli) 4Db/Fcon.  
Sat Soc.(Through)4db/Fcon.



**2220 167 01XX**  
Sat Priz (Sonlu)  
Sat Soc.(Dead End)



**2220 170 01XX**  
Tv Priz (Geçişli) 11Db  
Tv Socket (Thr) 11db



**2220 171 01XX**  
Tv Priz (Sonlu)  
Tv Soc.(Dead End) 11db



**2220 172 01XX**  
Tv Priz F Dişi  
Tv Socket F Female



## İKİLİ PRİZLER DOUBLE SOCKETS



## ÇERÇEVELER

Tekliden altılıya kadar  
çoklu anahtar ihtiyaçlarınızın  
çözümü...

## FRAMES

Multi-key solution for your  
needs from single up to six...

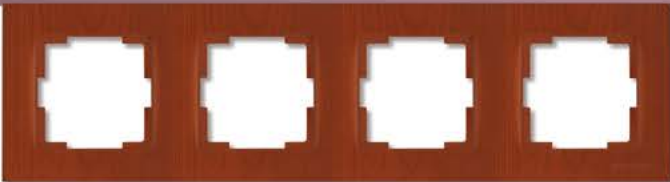
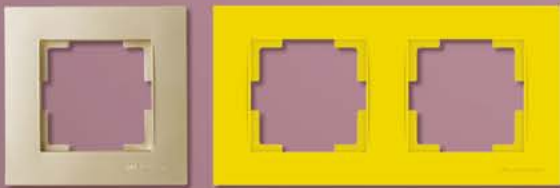

## TELEFON TUTUCU TELEPHONE HOLDER

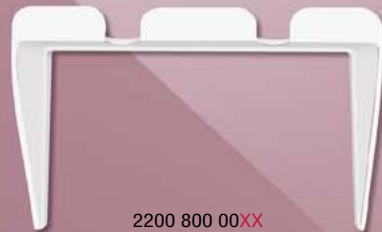

2200 800 00XX

# RENK SEÇENEKLERİ COLOR OPTIONS

## NATUREL • NATURAL



XX : 01 Beyaz • White



XX : 02 Krem • Cream

## PASTEL • PASTEL



Çerçeve / Frame (XX)  
03 Gri • Grey

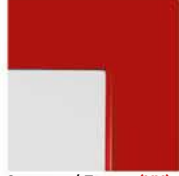

Çerçeve / Frame (XX)  
04 Kırmızı • Red



Çerçeve / Frame (XX)  
06 Turuncu • Orange



Çerçeve / Frame (XX)  
08 Sarı • Yellow



Çerçeve / Frame (XX)  
09 Lacivert • Navy Blue



Çerçeve / Frame (XX)  
10 Yeşil • Green



Çerçeve / Frame (XX)  
11 Pembe • Pink



Çerçeve / Frame (XX)  
12 Mavi • Blue



Çerçeve / Frame (XX)  
25 Mor • Purple

## METALİK • METALLIC



XX : 80  
Antik altın • Antique gold



XX : 82  
İnoks • Inox



XX : 83  
Titanyum • Titanium



XX : 84  
Siyah • Black



XX : 85  
Dore • Dore



XX : 86  
Antrasit • Anthracite



XX : 96  
Füme • Smoked

## AHŞAP DESEN • WOOD PATTERN



XX : 56 Kiraz • Cherry



XX : 57 Ceviz • Walnuts



XX : 58 Meşe • Oak

## YATAY ÇERÇEVELER • HORIZONTAL FRAMES

2220 800 11 XX  
1'li Çerçeve  
1 Gang frame



2220 800 12 XX  
2'li Çerçeve  
2 Gang frame



2220 820 12 XX  
2'li Priz Çerçeve  
Double Socket frame

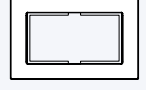

2220 800 13 XX  
3'lü Çerçeve • 3 Gang frame

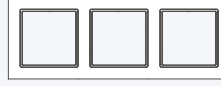

2220 800 14 XX  
4'lü Çerçeve • 4 Gang frame

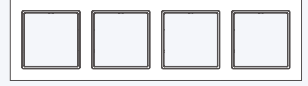

2220 800 15 XX  
5'li Çerçeve • 5 Gang frame

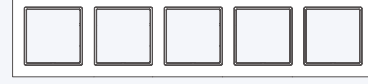

2220 800 16 XX  
6'li Çerçeve • 6 Gang frame



## DİKEY ÇERÇEVELER • VERTICAL FRAMES

2220 800 22 XX  
2'li Çerçeve  
2 Gang frame



2220 800 23 XX  
3'lü Çerçeve  
3 Gang frame



2220 800 24 XX  
4'lü Çerçeve  
4 Gang frame



2220 800 25 XX  
5'li Çerçeve  
5 Gang frame



2220 800 26 XX  
6'li Çerçeve  
6 Gang frame



Bu ürün kodlarında XX çerçeve rengini belirtmektedir.  
XX specify frame color for these products.

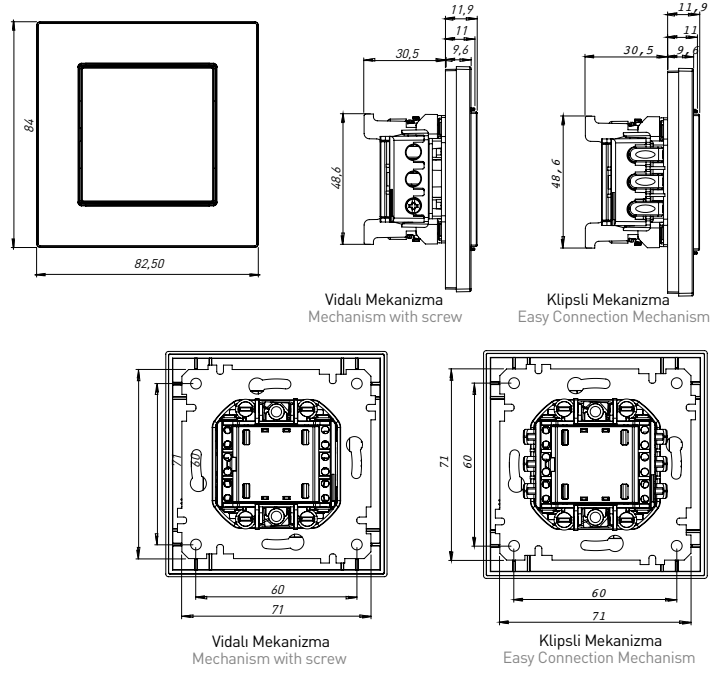

## MEKANİZMA + TUŞ ÜRÜN LİSTESİ • MECHANISM + SWITCH PRODUCT LIST

Kod / Code	Ürün Tanımı	Description
<b>ANAHTAR GRUBU VİDALI</b>		
2200 401 02XX	ANAHTAR (VİDALI)	ONE GANG ONE WAY SWITCH
2200 402 02XX	KOMÜTATÖR (VİDALI)	TWO GANG ONE WAY SWITCH
2200 403 02XX	VAVİEN(İKİ YOLLU ANAHTAR) (VİDALI)	ONE GANG TWO WAY SWITCH (VA-ET-VIENT)
2200 404 02XX	KOMÜTATÖR VAVİEN (VİDALI)	TWO GANG TWO WAY SWITCH (COMMUTATOR VEAVIEN)
2200 405 02XX	ÇİFT KUTUPLU ANAHTAR (VİDALI)	DOUBLE POLE SWITCH
2200 406 02XX	JALUZİ ANAHTARI-YAYLI (VİDALI)	BLIND SWITCH (CONTROL SWITCH)
2200 407 02XX	ÇAĞIRMA (LİGHT) (VİDALI)	ONE GANG ONE WAY SWITCH ( LIGHT ) ( PUSH Plate)
2200 407 02XXK	KAPI OTOMATIĞI ANAHTARI (VİDALI)	DOOR SWITCH
2200 407 02XXZ	ZİL ANAHTARI (VİDALI)	BELL SWITCH
2200 408 02XX	DEVIATÖR (ARA VAVİEN) (VİDALI)	ONE GANG INTERMEDIATE SWITCH
2200 409 02XX	ÜÇLÜ ANAHTAR (VİDALI)	THREE GANG ONE WAY SWITCH
2200 411 02XX	ŞOFBEN ANAHTARI (VİDALI)	HEATER SWITCH
2200 415 02XX	İŞIKLI ANAHTAR (220V) (VİDALI)	ILLUMINATED ONE (220V)GANG ONE WAY SWITCH
2200 416 02XX	İŞIKLI VAVİEN (220V) (VİDALI)	ILLUMINATED ONE GANG TWO WAY
2200 417 02XX	İŞIKLI ÇAĞIRMA(220V) (VİDALI)	ILLUMINATED ONE GANG ONE WAY ( PUSH Plate) SWITCH)
2200 418 02XX	İŞIKLI ETİKETLİ ANAHTAR (220V) (VİDALI)	ILLUMINATED 1 G 1 W SWITCH WITH LABEL
2200 419 02XX	İŞIKLI ETİKETLİ ÇAĞIRMA (220V) (VİDALI)	ILLUMINATED 1 G 1 W SWITCH WITH LABEL ( PUSH Plate)
2200 422 02XX	İŞIKLI ZİL ÇAĞIRMA (12V) (VİDALI)	ILLUMINATED ONE GANG ONE WAY SWITCH ( PUSH Plate)
2200 425 02XX	TEK TUŞLU JALUZİ ANAHTARI (VİDALI)	SINGLE BLIND SWITCH
2200 426 02XX	İŞIKLI KOMÜTATÖR (VİDALI)	ILLUMINATED TWO GANG ONE WAY SWITCH (220V)
2200 436 02XX	JALUZİ ANAHTARI YAYSIZ (VIDALI)	BLIND SWITCH
<b>SWITCH GROUP (WITH SCREW)</b>		

Kod / Code	Ürün Tanımı	Description
<b>ANAHTAR GRUBU KLİPSLİ</b>		
2200 401 01XX	ANAHTAR (KLİPSLİ)	ONE GANG ONE WAY SWITCH
2200 402 01XX	KOMÜTATÖR (KLİPSLİ)	TWO GANG ONE WAY SWITCH
2200 403 01XX	VAVİEN(İKİ YOLLU ANAHTAR) (KLİPSLİ)	ONE GANG TWO WAY SWITCH (VA-ET-VIENT)
2200 404 01XX	KOMÜTATÖR VAVİEN (KLİPSLİ)	TWO GANG TWO WAY SWITCH (COMMUTATOR VEAVIEN)
2200 405 01XX	ÇİFT KUTUPLU ANAHTAR (KLİPSLİ)	DOUBLE POLE SWITCH
2200 406 01XX	JALUZİ ANAHTARI-YAYLI (KLİPSLİ)	BLIND SWITCH (CONTROL SWITCH)
2200 407 01XX	ÇAĞIRMA (LİGHT) (KLİPSLİ)	ONE GANG ONE WAY SWITCH ( LIGHT ) ( PUSH Plate)
2200 407 01XXK	KAPI OTOMATIĞI ANAHTARI (KLİPSLİ)	DOOR SWITCH
2200 407 01XXZ	ZİL ANAHTARI (KLİPSLİ)	BELL SWITCH
2200 408 01XX	DEVIATÖR (ARA VAVİEN) (KLİPSLİ)	ONE GANG INTERMEDIATE SWITCH
2200 409 01XX	ÜÇLÜ ANAHTAR (KLİPSLİ)	THREE GANG ONE WAY SWITCH
2200 415 01XX	İŞIKLI ANAHTAR (220V) (KLİPSLİ)	ILLUMINATED ONE (220V)GANG ONE WAY SWITCH
2200 416 01XX	İŞIKLI VAVİEN (220V) (KLİPSLİ)	ILLUMINATED ONE GANG TWO WAY
2200 417 01XX	İŞIKLI ÇAĞIRMA(220V) (KLİPSLİ)	ILLUMINATED ONE GANG ONE WAY ( PUSH Plate) SWITCH)
2200 418 01XX	İŞIKLI ETİKETLİ ANAHTAR (220V) (KLİPSLİ)	ILLUMINATED 1 G 1 W SWITCH WITH LABEL
2200 419 01XX	İŞIKLI ETİKETLİ ÇAĞIRMA (220V) (KLİPSLİ)	ILLUMINATED 1 G 1 W SWITCH WITH LABEL ( PUSH Plate)
2200 422 01XX	İŞIKLI ZİL ÇAĞIRMA (12V) (KLİPSLİ)	ILLUMINATED ONE GANG ONE WAY SWITCH ( PUSH Plate)
2200 425 01XX	TEK TUŞLU JALUZİ ANAHTARI (VİDALI)	SINGLE BLIND SWITCH
2200 426 01XX	İŞIKLI KOMÜTATÖR (KLİPSLİ)	ILLUMINATED TWO GANG ONE WAY SWITCH (220V)
2200 436 01XX	JALUZİ ANAHTARI YAYSIZ (KLİPSLİ)	BLIND SWITCH
<b>SWITCH GROUP EASY CONNECTION</b>		

**MEKANİZMA + TUŞ ÜRÜN LİSTESİ • MECHANISM + SWITCH PRODUCT LIST**

Kod / Code	Ürün Tanımı	Description
<b>DİMMER GRUBU</b>		<b>DIMMER GROUP</b>
2200 440 02XX	IŞIKLI DİMMER (600 W)	RL ROTARY DIMMER (600 W)
2200 444 02XX	IŞIKLI DİMMER (1000 W)	RL ROTARY DIMMER (1000 W)
2200 447 02XX	RC DİMMER(325 W)	RC DIMMER (325 W)
<b>ELEKTRONİK GRUBU</b>		<b>ELECTRONIC GROUP</b>
2200 450 01XX	ENERGY SAVER GECİKMESİZ IŞIKLI	ENERGY SAVER ILLUMINATED
2200 452 01XX	ENERGY SAVER GECİKMELİ IŞIKLI	ENERGY SAVER WITH DELAY
2200 470 02XX	MÜZİK YAYIN ANAHTARI	AUDIO SWITCH
2200 480 01XX	HOPARLÖR PRİZİ	SPEAKER SOCKET
2200 485 02XX	UYARI ZİLİ	WARNING SWITCH
2200 495 02XX	HAREKET SENSÖRÜ	MOVEMENT SENSOR
<b>PRİZ GRUBU</b>		<b>SOCKET GROUP</b>
2200 600 02XX	TOPRAKLI PRİZ	EARTHED SOCKET OUTLET
2200 601 02XX	TOPRAKSIZ PRİZ	SOCKET OUTLET NON- EARTHED
2200 605 02XX	TOPRAKLI PRİZ (ÇOCUK KORUMALI)	EARTHED SOCKET WITH CHILD PROTECTION
2200 606 02XX	TOPRAKSIZ PRİZ (ÇOCUK KORUMALI)	SOCKET OUTLET WITH CHILD PROTECTION NON EARTHED
2200 610 02XX	KAPAKLI TOPRAKLI PRİZ	EARTHED SOCKET WITH COVER
2200 611 02XX	KAPAKLI TOPRAKLI PRİZ (ÇOCUK KORUMALI)	EARTHED SOCKET WITH CHILD PROTECTION COVER
2200 615 02XX	UPS (FRANSIZ) PRİZİ	UPS (FRENCH) SOCKET (EARTHED SOCKET WITH PIN)
2200 616 02XX	UPS (FRANSIZ) PRİZİ (ÇOCUK KORUMALI)	UPS (FRENCH) SOCKET (CHILD PROTECTION)
2200 617 02XX	UPS KAPAKLI(FRANSIZ) PRİZİ	UPS SOCKET (FRENCH) WITH COVER
2200 618 02XX	UPS (FRANSIZ)KAP. TOPRAKLI PRİZ (ÇOC.KRM)	UPS SOCKET (FRENCH) WITH COVER (CHILD PROTECTION)
2200 200 02XX	İKİLİ TOPRAKLI PRİZ (PORSELEN)	DOUBLE SOCKET EARTHED PORCELAIN
2200 201 02XX	İKİLİ TOPRAKSIZ PRİZ (PORSELEN)	DOUBLE SOCKET (NON EARTHED) PORCELAIN
2200 202 02XX	İKİLİ TOPRAKLI PRİZ	DOUBLE SOCKET EARTHED
2200 203 02XX	İKİLİ TOPRAKSIZ PRİZ	DOUBLE SOCKET (NON EARTHED)
2200 215 02XX	İKİLİ UPS PRİZ	DOUBLE SOCKET WITH UPS (FRENCH)
2200 448 02XX	TEKLİ USB ŞARJ PRİZİ	USB CHARGE SOCKET
2200 449 02XX	İKİLİ USB ŞARJ PRİZİ	USB CHARGE TWO SOCKET
2200 469 02XX	USB + TYPE-C ŞARJ PRİZİ	USB + TYPE-C CHARGE SOCKET
2220 619 02XX	İKİLİ USB TOPRAKLI PRİZ (ÇERÇEVE DAHİL)	EARTHED SOCKET DOUBLE USB (WITH FRAME)
2220 629 02XX	USB + TYPE-C'Lİ TOP. PRİZ (ÇERÇEVE DAHİL)	2*USB +TYPE-C CHARGER
<b>İLETİŞİM GRUBU</b>		<b>COMMUNICATIONS GROUP</b>
2200 125 01XX	TELEFON PRİZİ 1*RJ12 (CAT 3)	TELEPHONE SOCKET 1*RJ12 (CAT 3)
2200 126 01XX	TELEFON PRİZİ 2*RJ12 (CAT 3)	TELEPHONE SOCKET 2*RJ12 (CAT 3)
2200 128 01XX	ETİKETLİ TELEFON DATA PRİZ (KON.SÜZ)	TELEPHONE DATA SOCKET WITH LABEL (WITHOUT CONNECTOR)
2200 135 01XX	DATA PRİZ 1*RJ45 (KONNEKTÖRSÜZ)	DATA SOCKET 1*RJ45 (WITHOUT CONNECTOR)
2200 136 01XX	DATA PRİZ 1*RJ45 (CAT 5E)	DATA SOCKET 1*RJ45 (CAT 5E)
2200 137 01XX	DATA PRİZ 2*RJ45 (KONNEKTÖRSÜZ)	DATA SOCKET 2*RJ45 (WITHOUT CONNECTOR)
2200 138 01XX	DATA PRİZ 2*RJ45 (CAT 5E)	DATA SOCKET 2*RJ45 (CAT 5E)
2200 139 01XX	DATA PRİZ (RJ12 CAT 3+CAT 5 E)	DATA SOCKET (RJ12 CAT 3+CAT 5 E)
2200 140 01XX	DATA PRİZ 1*RJ45 (CAT 6)	DATA SOCKET 1*RJ45 (CAT 6)
2200 141 01XX	DATA PRİZ 2*RJ45 (CAT 6)	DATA SOCKET 2*RJ45 (CAT 6)
2200 455 01XX	DATA PRİZ 1*USB	DATA SOCKET 1* USB
2200 456 01XX	DATA PRİZ 2*USB	DATA SOCKET 2* USB
2200 457 01XX	DATA PRİZ 1*HDMI	DATA SOCKET 1*HDMI
2200 458 01XX	DATA PRİZ 2*HDMI	DATA SOCKET 2*HDMI
2200 459 01XX	DATA PRİZ 1*USB / 1*HDMI	DATA SOCKET 1*USB / 1*HDMI
2200 460 01XX	VGA PRİZ	VGA SOCKET
2200 461 01XX	İKİ ÇIKIŞLI FİBER OPTİK PRİZ	TWO-OUTPUT FIBER OPTIC SOCKET
2200 121 02XX	KÖR KAPAK	BLIND COVER
<b>TV / SAT GRUBU</b>		<b>TV / SAT GROUP</b>
2200 156 02XX	TV / SAT PRİZİ (GEÇİŞLİ) 4DB/F KON.	TV / SAT SOCKET (THROUGH) 4DB/F CON.
2200 157 02XX	TV / SAT PRİZİ (SONLU)	TV / SAT SOCKET (DEAD-END)
2200 166 01XX	SAT PRİZİ (GEÇİŞLİ) 4DB/F KON.	SAT SOCKET (THROUGH)
2200 167 01XX	SAT PRİZİ (SONLU)	SAT SOCKET (DEAD-END)
2200 170 01XX	TV PRİZİ (GEÇİŞLİ) 11 DB	TV SOCKET (THROUGH) 11 DB
2200 171 01XX	TV PRİZİ (SONLU)	TV SOCKET (DEAD-END)
2200 172 01XX	TV PRİZİ F DIŞI	TV SOCKET F FEMALE
<b>SIVAÜSTÜ KASA</b>		<b>SURFACE BOX</b>
2100 000 11XX	SIVAÜSTÜ KASA	SURFACE MOUNTED BOX
2200 000 11XX	SIVA ÜSTÜ ANAHTAR KASASI (GEÇMELİ)	SURFACE MOUNTED SWITCH BOX
<b>AKSESUAR</b>		<b>ACCESSORIES</b>
2200 800 00XX	TELEFON TUTUCU	TELEPHONE HOLDER
2200 000 0001	KTP IP44 PRİZ CONTA	SOCKET GASKET



RCA PRİZ  
RCA SOCKET



USB PRINTER PRİZ  
USB PRINTER SOCKET



MİKROFON PRİZ 6.3  
MICROPHONE SOCKET 6.3



XLR DİŞİ PRİZ  
XLR FEMALE SOCKET



XLR ERKEK PRİZ  
XLR MALE SOCKET



XLR 3,5 SES JAKI  
XLR 3,5 AUDIO CONNECTOR

## ÜRÜN LİSTESİ • PRODUCT LIST

Kod / Code	Ürün Tanımı	Description
2200 250 01XX	RİTA MİKROFON PRİZ 6.3	RITA MICROPHONE SOCKET 6.3
2200 251 01XX	RİTA RCA PRİZ	RITA RCA SOCKET
2200 252 01XX	RİTA 3,5 SES JAKI	RITA 3,5 AUDIO CONNECTOR
2200 253 01XX	RİTA XLR ERKEK PRİZ	RITA XLR MALE SOCKET
2200 254 01XX	RİTA XLR DİŞİ PRİZ	RITA XLR FEMALE SOCKET
2200 255 01XX	RİTA USB PRINTER PRİZ	RITA USB PRINTER SOCKET
2100 250 01XX	SPEAKHOMNE PRİZ	SPEAKHOMNE SOCKET
2100 251 01XX	RCA PRİZ	RCA SOCKET
2100 252 01XX	3,5 SES JAKI	3,5 AUDIO CONNECTOR
2100 253 01XX	XLR ERKEK PRİZ	XLR MALE SOCKET
2100 254 01XX	XLR DİŞİ PRİZ	XLR FEMALE SOCKET
2100 255 01XX	USB PRINTER PRİZ	USB PRINTER SOCKET



## ÜRÜN LİSTESİ • PRODUCT LIST

Kod / Code	Ürün Tanımı	Description
2100 852 0000	30A + 16A ENERGY SAVER ROLE PCB (VRF/FC)	30A+16A ENERGY SAVER RELAY PCB(VRF/FC)
2100 853 0000	3X16A ENERGY SAVER ROLE PCB (VRF/FC)	3X16A ENERGY SAVER - DND RELAY PCB (VRF/FC)
2100 854 0000	3X16A ENERGY SAVER - DND ROLE PCB (VRF/FC)	30A+2X16A ENERGY SAVER - DND RELAY PCB (VRF/FC)
2100 855 0000	30A+2X16A ENERGY SAVER - DND ROLE PCB (VRF/FC)	30A+2X16A ENERGY SAVER - DND RELAY PCB (VRF/FC)
2110 452 00XX	ENERGY SAVER KAPAK	ENERGY SAVER COVER
2220 410 01XX	RİTA OTEL UYARI İÇ ÜNİTESİ KOMÜTATÖRÜ (MEKANİK) IŞIKLI (KLİPSLİ)	RITA HOTEL INTERIOR WARNING UNIT 2 GANG 1 WAY - MECHANICAL ILLUMINATED WITH (EASY CONNECTION)
2220 410 02XX	RİTA OTEL UYARI İÇ ÜNİTESİ KOMÜTATÖRÜ (MEKANİK) IŞIKLI (VİDALI)	RITA HOTEL INTERIOR WARNING UNIT 2 GANG 1 WAY - MECHANICAL ILLUMINATED WITH (WITH SCREW)
2200 412 01XX	RİTA MEKANİZMA+TUŞ İMPLUS ANAHTAR (KLİPSLİ)	RITA MECHANISM+PLATE İMPLUS 1 GANG 1 WAY (EASY CONNECTION)
2200 412 02XX	RİTA MEKANİZMA+TUŞ İMPLUS ANAHTAR (VİDALI)	RITA MECHANISM+PLATE İMPLUS 1 GANG 1 WAY (WITH SCREW)
2200 423 01XX	RİTA MEKANİZMA+TUŞ İMPLUS KOMÜTATÖR (KLİPSLİ)	RITA MECHANISM + PLATE İMPLUS 2 GANG 1 WAY (EASY CONNECTION)
2200 423 02XX	RİTA MEKANİZMA+TUŞ İMPLUS KOMÜTATÖR (VİDALI)	RITA MECHANISM + PLATE İMPLUS 2 GANG 1 WAY (WITH SCREW)
2200 424 01XX	RİTA MEKANİZMA+TUŞ İMPLUS IŞIKLI ANAHTAR (KLİPSLİ)	RITA MECHANISM + PLATE İMPLUS ILLUMINATED 1 GANG 1 WAY SWITCH (EASY CONNECTION)
2200 424 02XX	RİTA MEKANİZMA+TUŞ İMPLUS IŞIKLI ANAHTAR (VİDALI)	RITA MECHANISM + PLATE İMPLUS ILLUMINATED 1 GANG 1 WAY SWITCH (WITH SCREW)
2200 427 01XX	RİTA MEKANİZMA+TUŞ İMPLUS IŞIKLI KOMÜTATÖR (KLİPSLİ)	RITA MECHANISM + PLATE İMPLUS ILLUMINATED 2 GANG 1 WAY (EASY CONNECTION)
2200 427 02XX	RİTA MEKANİZMA+TUŞ İMPLUS IŞIKLI KOMÜTATÖR (VİDALI)	RITA MECHANISM + PLATE İMPLUS ILLUMINATED 2 GANG 1 WAY (WITH SCREW)
2125 410 01XX	OTEL UYARI İÇ ÜNİTESİ KOMÜTATÖRÜ (MEKANİK) IŞIKLI (KLİPSLİ)	HOTEL INTERIOR WARNING UNIT 2 GANG 1 WAY - MECHANICAL ILLUMINATED WITH (EASY CONNECTION)
2100 412 01XX	İMPLUS ANAHTAR (KLİPSLİ)	İMPLUS ONE GANG ONE WAY SWITCH (EASY CONNECTION)
2100 423 01XX	İMPLUS KOMÜTATÖR (KLİPSLİ)	İMPLUS TWO GANG ONE WAY SWITCH (EASY CONNECTION)
2100 424 01XX	İMPLUS IŞIKLI ANAHTAR (220 V) (KLİPSLİ)	İMPLUS ILLUMINATED 1 GANG 1 WAY SWITCH (220V) (EASY CONNECTION)
2100 427 01XX	İMPLUS IŞIKLI KOMÜTATÖR (KLİPSLİ)	İMPLUSE 1 GANG 1 WAY SWITCH (EASY CONNECTION)



## Göz alıcı ...

Usta elinden çıkmış, incelikle düşünülmüş nadir bir mücevher gibi göz alacak...





# Chrome

KROM • CHROME



## Eye-catching ...

Eye-catching as a rare jewel of master craftsmanship, delicately conceived...





## Seçkin ürünler...

Formunu ve desenini doğanın eşsiz görünümünden alan sadeliği ile ön plana çıkan seçkin ürünler...





## Excellent products...

Excellent products that come to the forefront with the design of the form and the design with the unique appearance of nature ...





## Sıradanlığa meydan okuyun...

Modern mekanların vazgeçilmez üyeleri,  
farklı beğenilere cevap verebilmek için tasarlandı...

## Challenge ordinariness...

Indispensable members of  
modern spaces are  
designed to respond to  
different tastes ...



## ÇERÇEVELER

Tekliden altılıya kadar çoklu anahtar ihtiyaçlarınızın çözümü...

## FRAMES

Multi-key solution for your needs from single up to six...

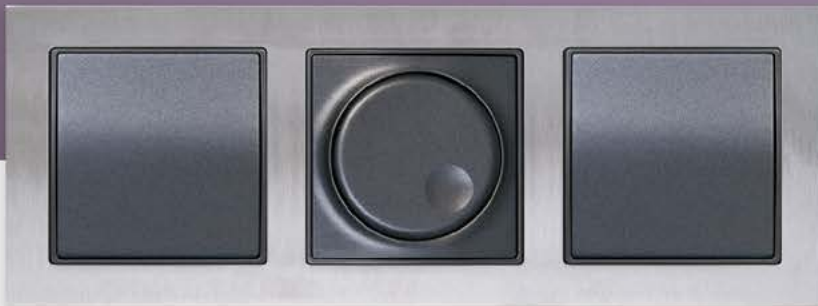

## RENK SEÇENEKLERİ COLOR OPTIONS

### Elitra Glass



Cerçeve (XX) : 11 Beyaz  
Tuş (YY) : 01 Beyaz  
Frame (XX) : 11 White  
Plate (YY) : 01 White



Cerçeve (XX) : 14 Siyah  
Tuş (YY) : 92 Gümüş  
Frame (XX) : 14 Black  
Plate (YY) : 92 Silver

### Elitra Chrome



Cerçeve (XX) : 21 Krom  
Tuş (YY) : 95 Fümé  
Frame (XX) : 21 Chrome  
Plate (YY) : 95 Smoked



Cerçeve (XX) : 22 Altın  
Tuş (YY) : 90 Saten  
Frame (XX) : 22 Gold  
Plate (YY) : 90 Satin



Cerçeve (XX) : 24 Paslanmaz Çelik  
Tuş (YY) : 95 Fümé  
Frame (XX) : 24 Stainless Steel  
Plate (YY) : 95 Smoked



Cerçeve (XX) : 25 Parlak Fümé  
Tuş (YY) : 92 Gümüş  
Frame (XX) : 25 Bright Smoked  
Plate (YY) : 92 Silver



Cerçeve (XX) : 25 Parlak Fümé  
Tuş (YY) : 95 Fümé  
Frame (XX) : 25 Bright Smoked  
Plate (YY) : 95 Smoked



Cerçeve (XX) : 27 Mat Alüminyum  
Tuş (YY) : 95 Fümé  
Frame (XX) : 27 Mat Aluminium  
Plate (YY) : 95 Smoked



Cerçeve (XX) : 28 Mat Saten  
Tuş (YY) : 90 Saten  
Frame (XX) : 28 Mat Satin  
Plate (YY) : 90 Satin

### Elitra Wood



Cerçeve (XX) : 32 Kayın  
Tuş (YY) : 92 Gümüş  
Frame (XX) : 32 Beech  
Plate (YY) : 92 Silver



Cerçeve (XX) : 33 Kiraz  
Tuş (YY) : 90 Saten  
Frame (XX) : 33 Cherry  
Plate (YY) : 90 Satin



Cerçeve (XX) : 34 Venge  
Tuş (YY) : 92 Gümüş  
Frame (XX) : 34 Venge  
Plate (YY) : 92 Silver

### Elitra Marble



Cerçeve (XX) : 42 Black Quartz  
Tuş (YY) : 92 Gümüş  
Frame (XX) : 42 Black Quartz  
Plate (YY) : 92 Silver



Cerçeve (XX) : 43 Sand Stone  
Tuş (YY) : 92 Gümüş  
Frame (XX) : 43 Sand Stone  
Plate (YY) : 92 Silver

### Elitra Ale



Cerçeve (XX) : 51 Natural  
Tuş (YY) : 95 Fümé  
Frame (XX) : 51 Natural  
Plate (YY) : 92 Smoked



Cerçeve (XX) : 52 Saten  
Tuş (YY) : 90 Saten  
Frame (XX) : 52 Satin  
Plate (YY) : 90 Satin



Cerçeve (XX) : 53 Mat Fümé  
Tuş (YY) : 92 Gümüş  
Frame (XX) : 53 Mat Smoked  
Plate (YY) : 92 Silver

## YATAY ÇERÇEVELER • HORIZONTAL FRAMES

2170 8XX 11YY  
1'li Çerçeve • 1 Gang frame



2170 8XX 12YY  
2'li Çerçeve • 2 Gang frame



2170 8XX 13YY  
3'lü Çerçeve • 3 Gang frame



2170 8XX 14YY  
4'lü Çerçeve • 4 Gang frame



2170 8XX 15YY  
5'li Çerçeve • 5 Gang frame



2170 8XX 16YY  
6'li Çerçeve • 6 Gang frame



## DİKEY ÇERÇEVELER • VERTICAL FRAMES

2170 8XX 22YY  
2'li Çerçeve  
2 Gang frame



2170 8XX 23YY  
3'lü Çerçeve  
3 Gang frame



2170 8XX 24YY  
4'lü Çerçeve  
4 Gang frame

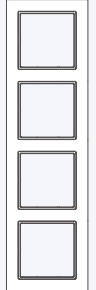

2170 8XX 25YY  
5'li Çerçeve  
5 Gang frame



2170 8XX 26YY  
6'li Çerçeve  
6 Gang frame



Bu ürün kodlarında XX çerçeve rengini YY kordon rengini belirtmektedir.  
For these products, XX indicates frame color, YY cord color.

# Elitra Plus

TEKNİK BİLGİLER  
TECHNICAL FEATURES

## BOYUTLAR • DIMENSIONS

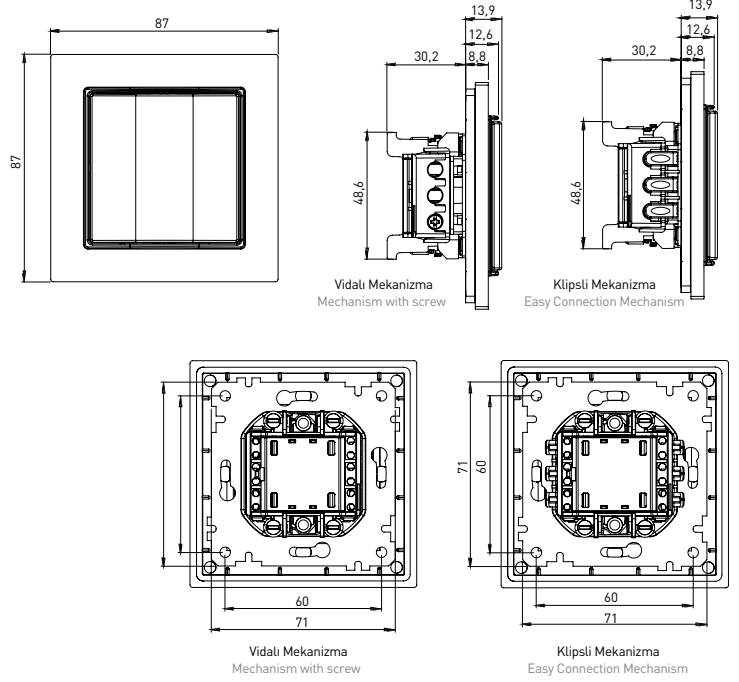

## MEKANİZMA + TUŞ ÜRÜN LİSTESİ • MECHANISM + SWITCH PRODUCT LIST

Kod / Code	Ürün Tanımı	Description
<b>ANAHTAR GRUBU VİDALI</b>		
<b>SWITCH GROUP (WITH SCREW)</b>		
2270 401 02XX	ANAHTAR (VİDALI)	ONE GANG ONE WAY SWITCH
2270 402 02XX	KOMÜTATÖR (VİDALI)	TWO GANG ONE WAY SWITCH
2270 403 02XX	VAVİEN(İKİ YOLLU ANAHTAR) (VİDALI)	ONE GANG TWO WAY SWITCH (VA-ET-VIENT)
2270 404 02XX	KOMÜTATÖR VAVİEN (VİDALI)	TWO GANG TWO WAY SWITCH (COMMUTATOR VEAVIEN)
2270 405 02XX	ÇİFT KUTUPLU ANAHTAR (VİDALI)	DOUBLE POLE SWITCH
2270 406 02XX	JALUZİ ANAHTARI-YAYLI (VİDALI)	BLIND SWITCH (CONTROL SWITCH)
2270 407 02XX	ÇAĞIRMA (LİGH) (VİDALI)	ONE GANG ONE WAY SWITCH ( LIGHT ) ( PUSH Plate)
2270 407 02XXK	KAPI OTOMATIĞI ANAHTARI (VİDALI)	DOOR SWITCH
2270 407 02XXZ	ZİL ANAHTARI (VİDALI)	BELL SWITCH
2270 408 02XX	DEVIATÖR (ARA VAVİEN) (VİDALI)	ONE GANG INTERMEDIATE SWITCH
2270 409 02XX	ÜÇLÜ ANAHTAR (VİDALI)	THREE GANG ONE WAY SWITCH
2270 411 02XX	ŞOFBEN ANAHTARI (VİDALI)	HEATER SWITCH
2270 415 02XX	IŞIKLI ANAHTAR (220V) (VİDALI)	ILLUMINATED ONE (220V)GANG ONE WAY SWITCH
2270 416 02XX	IŞIKLI VAVİEN (220V) (VİDALI)	ILLUMINATED ONE GANG TWO WAY
2270 417 02XX	IŞIKLI ÇAĞIRMA(220V) (VİDALI)	ILLUMINATED ONE GANG ONE WAY ( PUSH Plate) SWITCH)
2270 418 02XX	IŞIKLI ETİKETLİ ANAHTAR (220V) (VİDALI)	ILLUMINATED 1 G 1 W SWITCH WITH LABEL
2270 419 02XX	IŞIKLI ETİKETLİ ÇAĞIRMA (220V) (VİDALI)	ILLUMINATED 1 G 1 W SWITCH WITH LABEL ( PUSH Plate)
2270 422 02XX	IŞIKLI ZİL ÇAĞIRMA (12V) (VİDALI)	ILLUMINATED ONE GANG ONE WAY SWITCH ( PUSH Plate)
2270 426 02XX	IŞIKLI KOMÜTATÖR (VİDALI)	ILLUMINATED TWO GANG ONE WAY SWITCH (220V)
2270 436 02XX	JALUZİ ANAHTARI YAYSIZ (VİDALI)	BLIND SWITCH

<b>ANAHTAR GRUBU KLİPSLİ</b>		
<b>SWITCH GROUP EASY CONNECTION</b>		
2270 401 01XX	ANAHTAR (KLİPSLİ)	ONE GANG ONE WAY SWITCH
2270 402 01XX	KOMÜTATÖR (KLİPSLİ)	TWO GANG ONE WAY SWITCH
2270 403 01XX	VAVİEN(İKİ YOLLU ANAHTAR) (KLİPSLİ)	ONE GANG TWO WAY SWITCH (VA-ET-VIENT)
2270 404 01XX	KOMÜTATÖR VAVİEN (KLİPSLİ)	TWO GANG TWO WAY SWITCH (COMMUTATOR VEAVIEN)
2270 405 01XX	ÇİFT KUTUPLU ANAHTAR (KLİPSLİ)	DOUBLE POLE SWITCH
2270 406 01XX	JALUZİ ANAHTARI-YAYLI (KLİPSLİ)	BLIND SWITCH (CONTROL SWITCH)
2270 407 01XX	ÇAĞIRMA (LİGH) (KLİPSLİ)	ONE GANG ONE WAY SWITCH ( LIGHT ) ( PUSH Plate)
2270 407 01XXK	KAPI OTOMATIĞI ANAHTARI (KLİPSLİ)	DOOR SWITCH
2270 407 01XXZ	ZİL ANAHTARI (KLİPSLİ)	BELL SWITCH
2270 408 01XX	DEVIATÖR (ARA VAVİEN) (KLİPSLİ)	ONE GANG INTERMEDIATE SWITCH
2270 409 01XX	ÜÇLÜ ANAHTAR (KLİPSLİ)	THREE GANG ONE WAY SWITCH
2270 415 01XX	IŞIKLI ANAHTAR (220V) (KLİPSLİ)	ILLUMINATED ONE (220V)GANG ONE WAY SWITCH
2270 416 01XX	IŞIKLI VAVİEN (220V) (KLİPSLİ)	ILLUMINATED ONE GANG TWO WAY
2270 417 01XX	IŞIKLI ÇAĞIRMA(220V) (KLİPSLİ)	ILLUMINATED ONE GANG ONE WAY ( PUSH Plate) SWITCH)
2270 418 01XX	IŞIKLI ETİKETLİ ANAHTAR (220V) (KLİPSLİ)	ILLUMINATED 1 G 1 W SWITCH WITH LABEL
2270 419 01XX	IŞIKLI ETİKETLİ ÇAĞIRMA (220V) (KLİPSLİ)	ILLUMINATED 1 G 1 W SWITCH WITH LABEL ( PUSH Plate)
2270 422 01XX	IŞIKLI ZİL ÇAĞIRMA (12V) (KLİPSLİ)	ILLUMINATED ONE GANG ONE WAY SWITCH ( PUSH Plate)
2270 426 01XX	IŞIKLI KOMÜTATÖR (KLİPSLİ)	ILLUMINATED TWO GANG ONE WAY SWITCH (220V)
2270 436 01XX	JALUZİ ANAHTARI YAYSIZ (KLİPSLİ)	BLIND SWITCH



**MEKANİZMA + TUŞ ÜRÜN LİSTESİ • MECHANISM + SWITCH PRODUCT LIST**

Kod / Code	Ürün Tanımı	Description
<b>DİMMER GRUBU</b>		<b>DIMMER GROUP</b>
2270 440 02XX	IŞIKLI DİMMER (600 W)	RL ROTARY DIMMER (600 W)
2270 444 02XX	IŞIKLI DİMMER (1000 W)	RL ROTARY DIMMER (1000 W)
2270 447 02XX	RC DİMMER (325 W)	RC DIMMER (325 W)
<b>ELEKTRONİK GRUBU</b>		<b>ELECTRONIC GROUP</b>
2270 450 01XX	ENERGY SAVER GECİKMESİZ IŞIKLI	ENERGY SAVER ILLUMINATED
2270 452 01XX	ENERGY SAVER GECİKMELİ IŞIKLI	ENERGY SAVER WITH DELAY
2270 470 02XX	MÜZİK YAYIN ANAHTARI	AUDIO SWITCH
2270 480 01XX	HOPARLÖR PRİZİ	SPEAKER SOCKET
2270 485 02XX	UYARI ZİLİ	WARNING SWITCH
2270 495 02XX	HAREKET SENSÖRÜ	MOVEMENT SENSOR
<b>PRİZ GRUBU</b>		<b>SOCKET GROUP</b>
2270 600 02XX	TOPRAKLI PRİZ	EARTHED SOCKET OUTLET
2270 601 02XX	TOPRAKSIZ PRİZ	SOCKET OUTLET NON- EARTHED
2270 605 02XX	TOPRAKLI PRİZ (ÇOCUK KORUMALI)	EARTHED SOCKET WITH CHILD PROTECTION
2270 606 02XX	TOPRAKSIZ PRİZ (ÇOCUK KORUMALI)	SOCKET OUTLET WITH CHILD PROTECTION NON EARTHED
2270 610 02XX	KAPAKLI TOPRAKLI PRİZ	EARTHED SOCKET WITH COVER
2270 611 02XX	KAPAKLI TOPRAKLI PRİZ (ÇOCUK KORUMALI)	EARTHED SOCKET WITH CHILD PROTECTION WITH COVER
2270 615 02XX	UPS (FRANSIZ) PRİZİ	UPS (FRENCH) SOCKET (EARTHED SOCKET WITH PIN)
2270 616 02XX	UPS (FRANSIZ) PRİZİ (ÇOCUK KORUMALI)	UPS (FRENCH) SOCKET (CHILD PROTECTION)
2270 617 02XX	UPS KAPAKLI(FRANSIZ) PRİZİ	UPS SOCKET (FRENCH) WITH COVER
2270 618 02XX	UPS (FRANSIZ)KAP. TOPRAKLI PRİZ (ÇOC.KRM)	UPS SOCKET (FRENCH) CHILD PROTECTION WITH COVER
2270 448 02XX	TEKLİ USB ŞARJ PRİZİ	USB CHARGE SOCKET
2270 449 02XX	İKİLİ USB ŞARJ PRİZİ	USB CHARGE TWO SOCKET
2270 469 02XX	İKİLİ USB + TYPE-C ŞARJ PRİZİ	2*USB +TYPE-C CHARGER
<b>İLETİŞİM GRUBU</b>		<b>COMMUNICATIONS GROUP</b>
2270 125 01XX	TELEFON PRİZİ 1*RJ12 (CAT 3)	TELEPHONE SOCKET 1*RJ12 (CAT 3)
2270 126 01XX	TELEFON PRİZİ 2*RJ12 (CAT 3)	TELEPHONE SOCKET 2*RJ12 (CAT 3)
2270 128 01XX	ETİKETLİ TELEFON DATA PRİZ (KON.SÜZ)	TELEPHONE DATA SOCKET WITH LABEL (WITHOUT CONNECTOR)
2270 135 01XX	DATA PRİZ 1*RJ45 (KONNEKTÖRSÜZ)	DATA SOCKET 1*RJ45 (WITHOUT CONNECTOR)
2270 136 01XX	DATA PRİZ 1*RJ45 (CAT 5E)	DATA SOCKET 1*RJ45 (CAT 5E)
2270 137 01XX	DATA PRİZ 2*RJ45 (KONNEKTÖRSÜZ)	DATA SOCKET 2*RJ45 (WITHOUT CONNECTOR)
2270 138 01XX	DATA PRİZ 2*RJ45 (CAT 5E)	DATA SOCKET 2*RJ45 (CAT 5E)
2270 139 01XX	DATA PRİZ (RJ12 CAT 3+CAT 5 E)	DATA SOCKET (RJ12 CAT 3+CAT 5 E)
2270 140 01XX	DATA PRİZ 1*RJ45 (CAT 6)	DATA SOCKET 1*RJ45 (CAT 6)
2270 141 01XX	DATA PRİZ 2*RJ45 (CAT 6)	DATA SOCKET 2*RJ45 (CAT 6)
2270 455 01XX	DATA PRİZ 1*USB	DATA SOCKET 1* USB
2270 456 01XX	DATA PRİZ 2*USB	DATA SOCKET 2* USB
2270 457 01XX	DATA PRİZ 1*HDMI	DATA SOCKET 1*HDMI
2270 458 01XX	DATA PRİZ 2*HDMI	DATA SOCKET 2*HDMI
2270 459 01XX	DATA PRİZ 1*USB / 1*HDMI	DATA SOCKET 1*USB / 1*HDMI
2270 460 01XX	VGA PRİZ	VGA SOCKET
2270 121 02XX	KÖR KAPAK	BLIND COVER
<b>TV / SAT GRUBU</b>		<b>TV / SAT GROUP</b>
2270 156 02XX	TV / SAT PRİZİ (GEÇİŞLİ) 4DB/F KON.	TV / SAT SOCKET (THROUGH) 4DB/F CON.
2270 157 02XX	TV / SAT PRİZİ (SONLU)	TV / SAT SOCKET (DEAD-END)
2270 166 01XX	SAT PRİZİ (GEÇİŞLİ) 4DB/F KON.	SAT SOCKET (THROUGH)
2270 167 01XX	SAT PRİZİ (SONLU)	SAT SOCKET (DEAD-END)
2270 170 01XX	TV PRİZİ (GEÇİŞLİ) 11 DB	TV SOCKET (THROUGH) 11 DB
2270 171 01XX	TV PRİZİ (SONLU)	TV SOCKET (DEAD-END)
2270 172 01XX	TV PRİZİ F DİŞİ	TV SOCKET F FEMALE
<b>SIVA ÜSTÜ KASA</b>		<b>SURFACE BOX</b>
2100 000 11XX	SIVA ÜSTÜ KASA	SURFACE MOUNTED BOX



## Şık çözümler...

Zarif ve ince çizgileriyle konforunuzu artıran, şıklığınızı tamamlayan çözümler geliştirdik.

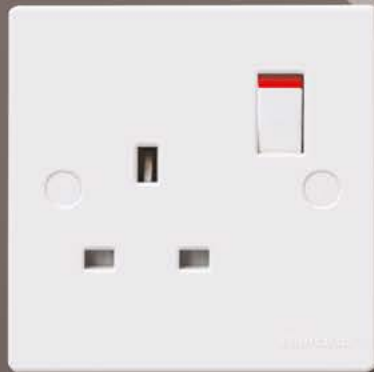

# Metallic

METALİK • METALLIC



## Elegant solutions ...

We have developed solutions that enhance comfort with elegant and subtle lines, complementing your elegance...

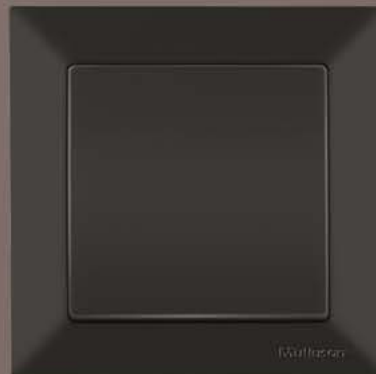



## Mekanınızla uyumlu...

Dekorasyonunuzu bütünleyen şık görünümü tamamlayan ustaca dokunuşlar.

## Compatible with your place...

The masterful touches that complement the elegant look that completes your decoration.



# ÇERÇEVELER

Tekliden altılıya kadar çoklu anahtar ihtiyaçlarınızın çözümü...

## FRAMES

Multi-key solution for your needs from single up to six...

## RENK SEÇENEKLERİ

### COLOR OPTIONS

#### NATUREL • NATURAL



XX : 01 Beyaz • White



XX : 02 Krem • Ivory

#### METALİK • METALLIC



XX : 80 Antik altın • Antique gold



XX : 82 İnoks • Inox



XX : 83 Titanyum • Titanium



XX : 84 Siyah • Black



XX : 85 Dore • Dore



XX : 86 Antrasit • Anthracite



XX : 95 Füme • Smoked

#### AHŞAP DESEN • WOOD PATTERN



XX : 56 Kiraz • Cherry



XX : 57 Ceviz • Walnuts



XX : 58 Meşe • Oak

## YATAY ÇERÇEVELER • HORIZONTAL FRAMES

2125 800 11 XX  
1'li Çerçeve  
1 Gang frame



2125 800 12 XX  
2'li Çerçeve  
2 Gang frame



2125 820 12 XX  
2'li Priz Çerçeve  
Double Socket frame

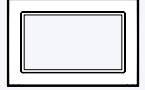

2125 800 13 XX  
3'lü Çerçeve • 3 Gang frame

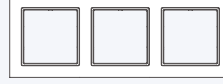

2125 800 14 XX  
4'lü Çerçeve • 4 Gang frame

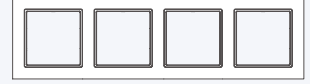

2125 800 15 XX  
5'li Çerçeve • 5 Gang frame

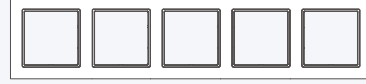

2125 800 16 XX  
6'li Çerçeve • 6 Gang frame



## DİKEY ÇERÇEVELER • VERTICAL FRAMES

2125 800 22 XX  
2'li Çerçeve  
2 Gang frame



2125 800 23 XX  
3'lü Çerçeve  
3 Gang frame



2125 800 24 XX  
4'lü Çerçeve  
4 Gang frame



2125 800 25 XX  
5'li Çerçeve  
5 Gang frame



2125 800 26 XX  
6'li Çerçeve  
6 Gang frame



Bu ürün kodlarında XX çerçeve rengini belirtmektedir.  
XX specify frame color for these products.

**ANAHTAR GRUBU  
VİDALI TİP  
SWITCH  
GROUP  
(WITH SCREW)**



2125 401 02XX  
Anahtar  
Oneq. One Way Switch

2125 402 02XX  
Komütatör  
Twoq. One Way Control

2125 403 02XX  
Vavien (İki Yollu Anahtar)  
Oneq. Two Way Switch

2125 404 02XX  
Komütatör Vavien  
Two Gang Two Way Switch

2125 405 02XX  
Çift Kutuplu Anahtar  
Oneq. One Way Dp

2125 406 02XX  
Jalousi Anahtar  
Blind Switch -W/Spring

2125 407 02XX  
Çağırma  
One Gang One Way Cont.

2125 407 02XXK  
Kapı Otomatığı Anahtar  
Door Switch



2125 407 02XXZ  
Zili Anahtar  
Ring Switch

2125 408 02XX  
Deviyatör (Ara Vavien)  
Oneq. Intermediate-Deviator

2125 409 02XX  
Üçlü Anahtar  
3 Gang Switch

2125 411 02XX  
Şöben Anahtar  
Heater Switch

2125 415 02XX  
Işıklı Anahtar (220V)  
İllu.1g.1w.Swi. (220v)

2125 416 02XX  
Işıklı Vavien (220V)  
İllu. Oneq. Two Way (220v)

2125 417 02XX  
Işıklı Çağırma (220V)  
İllu.1g.1w.Cntrl (220v)

2125 418 02XX  
Işıklı Etik. Anahtar (220V)  
İllu.1g.1w.W/Lab. (220v)

2125 419 02XX  
Işıklı Etik. Çağırma (220V)  
İllu.1g.1w.Cntrl/Lab. (220v)

**ANAHTAR GRUBU  
KLİPSLİ TİP  
(KOLAY BAĞLANTI)  
SWITCH  
GROUP  
(EASY CONNec.)**



2125 422 02XX  
Jalousi Zili Etik. Çağırma (12V)  
İllu.1g.1w.Cntrl (12v)

2125 426 02XX  
Işıklı Komütatör  
İllu.Twoq. One Way Switch

2125 436 02XX  
Jalousi Anahtar (Yaysız - Vidalı)  
Blind Switch (With Screw)

2125 401 01XX  
Anahtar  
Oneq. One Way Switch

2125 402 01XX  
Komütatör  
Twoq. One Way Control

2125 403 01XX  
Vavien (İki Yollu Anahtar)  
Oneq. Two Way Switch

2125 404 01XX  
Komütatör Vavien  
Two Gang Two Way Switch

2125 405 01XX  
Çift Kutuplu Anahtar  
Oneq. One Way Dp



2125 406 01XX  
Jalousi Anahtar  
Blind Switch -W/Spring

2125 407 01XX  
Çağırma  
One Gang One Way Control

2125 407 01XXK  
Kapı Otomatığı Anahtar  
Door Switch

2125 407 01XXZ  
Zili Anahtar  
Ring Switch

2125 408 01XX  
Deviyatör (Ara Vavien)  
Oneq. Intermediate-Deviator

2125 409 01XX  
Üçlü Anahtar  
3 Gang Switch

2125 415 01XX  
Işıklı Anahtar (220V)  
İllu.1g.1w.Swi. (220v)

2125 416 01XX  
Işıklı Vavien (220V)  
İllu. Oneq. Two Way (220v)

2125 417 01XX  
Işıklı Çağırma (220V)  
İllu.1g.1w.Cntrl (220v)

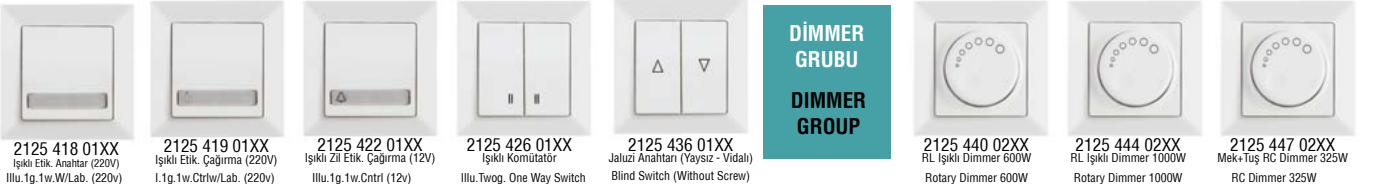

2125 418 01XX  
Işıklı Etik. Anahtar (220V)  
İllu.1g.1w.W/Lab. (220v)

2125 419 01XX  
Işıklı Etik. Çağırma (220V)  
İllu.1g.1w.Cntrl/Lab. (220v)

2125 422 01XX  
Işıklı Zili Etik. Çağırma (12V)  
İllu.1g.1w.Cntrl (12v)

2125 426 01XX  
Işıklı Komütatör  
İllu.Twoq. One Way Switch

2125 436 01XX  
Jalousi Anahtar (Yaysız - Vidalı)  
Blind Switch (Without Screw)

**DİMMER GRUBU  
DIMMER  
GROUP**

2125 440 02XX  
RL Işıklı Dimmer 600W  
Rotary Dimmer 600W

2125 444 02XX  
RL Işıklı Dimmer 1000W  
Rotary Dimmer 1000W

2125 447 02XX  
Mek+Tuş RC Dimmer 325W  
RC Dimmer 325W

**ELEKTRONİK GRUBU  
ELECTRONICS  
GROUP**



2125 450 01XX  
Energy Saver G.siz Işıklı  
Energy Saver Not Delay İllu.

2125 452 01XX  
Energy Saver Geçikmeli Işıklı  
Energy Saver Delay İllu.

2125 470 02XX  
Müzik Yayın Anahtar  
Audio Switch

2125 480 01XX  
Hoparlör Prizi  
Speaker Socket

2125 485 02XX  
Uyarı Zili  
Warning Bell

2125 495 02XX  
Hareket Sensörü  
Motion Sensor

**PRİZ GRUBU  
SOCKET  
GROUP**

2125 600 02XX  
Topraklı Priz  
Earthed Socket



2125 601 02XX  
Topraksız Priz  
Non Earthed Socket

2125 605 02XX  
Topraklı Priz (Çocuk Kor.)  
Earthed Socket (Child Prot.)

2125 606 02XX  
Topraksız Priz (Çocuk Kor.)  
Non Earthed Soc.-Child Prot.

2125 610 02XX  
Kapaklı Topraklı Priz  
Earthed Socket With Cover

2125 611 02XX  
Kapaklı Topraklı Priz (Çoc. Kor.)  
Earthed Soc.Cover (Ch. Prot.)

2125 615 02XX  
Ups (Fransız) Priz  
Ups (French) Soc. (Earthed)

2125 616 02XX  
Ups (Fransız) Priz (Çoc. Kor.)  
Ups (French) Soc. Child Prot.

2125 617 02XX  
Ups Kapaklı (Fransız) Priz  
Ups (French) Soc. With Cover

2125 618 02XX  
Ups Kapaklı (Fr.) Priz (Çoc. Kor.)  
Ups (French) Soc.W.Cover (C.P.)



2125 448 01XX  
Tekli Usb Şarj Prizi  
1\*Usb Charger

2125 449 01XX  
İkili Usb Şarj Prizi  
2\*Usb Charger

2125 200 02XX  
İkili Topraklı Priz Porselen  
Double Socket Earthed Porcelain

2125 201 02XX  
İkili Topraksız Priz Porselen  
Double Soc.Non Earthed Porcelain

2125 202 02XX  
İkili Topraklı Priz  
Double Socket Earthed

2125 203 02XX  
İkili Topraksız Priz  
Double Soc.Non Earthed

2125 215 02XX  
İkili Ups Priz  
Double Socket Ups

**İLETİŞİM  
GRUBU  
COMMUNICATION  
GROUP**

2125 125 01XX  
Telefon Prizi 1Xrj12 (Cat3)  
Phonsocket 1\*Rj12 (Cat3)



2125 126 01XX  
Telefon Prizi 2Xrj12 (Cat3)  
Telephone Soc.2xRj12



2125 128 01XX  
Etiketli Tif Data Priz (Kon.süz)  
Tif Data Soc.W/O Con. Label



2125 135 02XX  
Data Prizi 1\*Rj45 (Kon.süz)  
Data Soc.1\*Rj45w/Ocon.



2125 136 01XX  
Data Prizi 1\*Rj45 (Cat5e)  
Data Soc.1\*Rj45 (Cat5e)



2125 137 01XX  
Data Prizi 2\*Rj45 (Kon.süz)  
Data Soc.2\*Rj45w/Ocon.



2125 138 01XX  
Data Prizi 2\*Rj45 (Cat5e)  
Data Soc.2\*Rj45 (Cat5e)



2125 139 01XX  
Tif Data Priz (Rj12 Cat3 + Cat5e)  
Tif Data Soc.(Rj12 Cat3e)



2125 140 01XX  
Data Prizi 1\*Rj45 (Cat6)  
Data Soc.1\*Rj45 (Cat6)



2125 141 01XX  
Data Prizi 2\*Rj45 (Cat6)  
Data Soc.2\*Rj45 (Cat6)



2125 455 01XX  
Data Prizi 1\*Usb  
Data Soc.1\*Usb



2125 456 01XX  
Data Prizi 2\*Usb  
Data Soc.2\*Usb



2125 457 01XX  
Data Prizi 1\*Hdmi  
Data Soc.1\*Hdmi



2125 458 01XX  
Data Prizi 2\*Hdmi  
Data Soc.2\*Hdmi



2125 459 01XX  
Data Prizi 1\*Usb/1\*Hdmi  
Data Soc.1\*Usb/1\*Hdmi



2125 460 01XX  
VGA Priz  
Switch Vga Socket



2125 121 02XX  
Kör Kapak  
Blind Cover White

**TV / SAT  
GRUBU  
TV / SAT  
GROUP**

2125 156 02XX  
Tv-Sat Prizi (Geçişli) 4dB/F Kon.  
Tv-Sat Soc.Thr.4db/Fcon.



2125 157 02XX  
Tv-Sat Prizi (Sonlu)  
Tv-Sat Soc.(Dead End)



2125 166 01XX  
Sat Prizi (Geçişli) 4dB/F Kon.  
Sat Soc.(Through)4db/Fcon.



2125 167 01XX  
Sat Prizi (Sonlu)  
Sat Soc.(Dead End)



2125 170 01XX  
Tv Prizi (Geçişli) 11dB  
Tv Socket (Thr) 11db



2125 171 01XX  
Tv Prizi (Sonlu)  
Tv Soc.(Dead End) 11db



2125 172 01XX  
Tv Prizi F Dişi  
Tv Socket F Female



## BOYUTLAR • DIMENSIONS

# Candelä

TEKNİK BİLGİLER  
TECHNICAL FEATURES

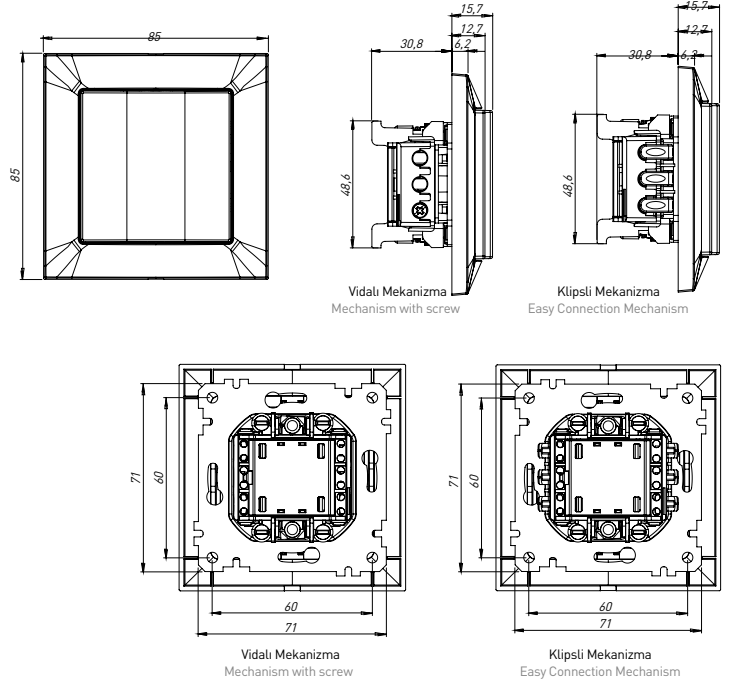

## MEKANİZMA + TUŞ ÜRÜN LİSTESİ • MECHANISM + SWITCH PRODUCT LIST

Kod / Code	Ürün Tanımı	Description
<b>ANAHTAR GRUBU VİDALI</b>		<b>SWITCH GROUP (WITH SCREW)</b>
2100 401 02XX	ANAHTAR (VİDALI)	ONE GANG ONE WAY SWITCH
2100 402 02XX	KOMÜTATÖR (VİDALI)	TWO GANG ONE WAY SWITCH
2100 403 02XX	VAVİEN(İKİ YOLLU ANAHTAR) (VİDALI)	ONE GANG TWO WAY SWITCH (VA-ET-VIENT)
2100 404 02XX	KOMÜTATÖR VAVİEN (VİDALI)	TWO GANG TWO WAY SWITCH (COMMUTATOR VEAVIEN)
2100 405 02XX	ÇİFT KUTUPLU ANAHTAR (VİDALI)	DOUBLE POLE SWITCH
2100 406 02XX	JALUZİ ANAHTARI-YAYLI (VİDALI)	BLIND SWITCH (CONTROL SWITCH)
2100 407 02XX	ÇAĞIRMA (LİGH) (VİDALI)	ONE GANG ONE WAY SWITCH ( LIGHT) ( PUSH Plate)
2100 407 02XXK	KAPI OTOMATIĞI ANAHTARI (VİDALI)	DOOR SWITCH
2100 407 02XXZ	ZİL ANAHTARI (VİDALI)	BELL SWITCH
2100 408 02XX	DEVIATÖR (ARA VAVİEN) (VİDALI)	ONE GANG INTERMEDIATE SWITCH
2100 409 02XX	ÜÇLÜ ANAHTAR (VİDALI)	THREE GANG ONE WAY SWITCH
2100 411 02XX	ŞOFBEN ANAHTARI (VİDALI)	HEATER SWITCH
2100 415 02XX	IŞIKLI ANAHTAR (220V) (VİDALI)	ILLUMINATED ONE (220V)GANG ONE WAY SWITCH
2100 416 02XX	IŞIKLI VAVİEN (220V) (VİDALI)	ILLUMINATED ONE GANG TWO WAY
2100 417 02XX	IŞIKLI ÇAĞIRMA(220V) (VİDALI)	ILLUMINATED ONE GANG ONE WAY ( PUSH Plate) SWITCH)
2100 418 02XX	IŞIKLI ETİKETLİ ANAHTAR (220V) (VİDALI)	ILLUMINATED 1 G 1 W SWITCH WITH LABEL
2100 419 02XX	IŞIKLI ETİKETLİ ÇAĞIRMA (220V) (VİDALI)	ILLUMINATED 1 G 1 W SWITCH WITH LABEL ( PUSH Plate)
2100 422 02XX	IŞIKLI ZİL ÇAĞIRMA (12V) (VİDALI)	ILLUMINATED ONE GANG ONE WAY SWITCH ( PUSH Plate)
2100 426 02XX	IŞIKLI KOMÜTATÖR (VİDALI)	ILLUMINATED TWO GANG ONE WAY SWITCH (220V)
2100 436 02XX	JALUZİ ANAHTARI YAYSIZ (VİDALI)	BLIND SWITCH (PUSH Plate)
<b>ANAHTAR GRUBU KLİPSLİ</b>		<b>SWITCH GROUP EASY CONNECTION</b>
2100 401 01XX	ANAHTAR (KLİPSLİ)	ONE GANG ONE WAY SWITCH
2100 402 01XX	KOMÜTATÖR (KLİPSLİ)	TWO GANG ONE WAY SWITCH
2100 403 01XX	VAVİEN(İKİ YOLLU ANAHTAR) (KLİPSLİ)	ONE GANG TWO WAY SWITCH (VA-ET-VIENT)
2100 404 01XX	KOMÜTATÖR VAVİEN (KLİPSLİ)	TWO GANG TWO WAY SWITCH (COMMUTATOR VEAVIEN)
2100 405 01XX	ÇİFT KUTUPLU ANAHTAR (KLİPSLİ)	DOUBLE POLE SWITCH
2100 406 01XX	JALUZİ ANAHTARI-YAYLI (KLİPSLİ)	BLIND SWITCH (CONTROL SWITCH)
2100 407 01XX	ÇAĞIRMA (LİGH) (KLİPSLİ)	ONE GANG ONE WAY SWITCH ( LIGHT) ( PUSH Plate)
2100 407 01XXK	KAPI OTOMATIĞI ANAHTARI (KLİPSLİ)	DOOR SWITCH
2100 407 01XXZ	ZİL ANAHTARI (KLİPSLİ)	BELL SWITCH
2100 408 01XX	DEVIATÖR (ARA VAVİEN) (KLİPSLİ)	ONE GANG INTERMEDIATE SWITCH
2100 409 01XX	ÜÇLÜ ANAHTAR (KLİPSLİ)	THREE GANG ONE WAY SWITCH
2100 415 01XX	IŞIKLI ANAHTAR (220V) (KLİPSLİ)	ILLUMINATED ONE (220V)GANG ONE WAY SWITCH
2100 416 01XX	IŞIKLI VAVİEN (220V) (KLİPSLİ)	ILLUMINATED ONE GANG TWO WAY
2100 417 01XX	IŞIKLI ÇAĞIRMA(220V) (KLİPSLİ)	ILLUMINATED ONE GANG ONE WAY ( PUSH Plate) SWITCH)
2100 418 01XX	IŞIKLI ETİKETLİ ANAHTAR (220V) (KLİPSLİ)	ILLUMINATED 1 G 1 W SWITCH WITH LABEL
2100 419 01XX	IŞIKLI ETİKETLİ ÇAĞIRMA (220V) (KLİPSLİ)	ILLUMINATED 1 G 1 W SWITCH WITH LABEL ( PUSH Plate)
2100 422 01XX	IŞIKLI ZİL ÇAĞIRMA (12V) (KLİPSLİ)	ILLUMINATED ONE GANG ONE WAY SWITCH ( PUSH Plate)
2100 426 01XX	IŞIKLI KOMÜTATÖR (KLİPSLİ)	ILLUMINATED TWO GANG ONE WAY SWITCH (220V)
2100 436 01XX	JALUZİ ANAHTARI YAYSIZ (KLİPSLİ)	BLIND SWITCH



**MEKANİZMA + TUŞ ÜRÜN LİSTESİ • MECHANISM + SWITCH PRODUCT LIST**

Kod / Code	Ürün Tanımı	Description
<b>DİMMER GRUBU</b>		<b>DIMMER GROUP</b>
2100 440 02XX	IŞIKLI DİMMER (600 W)	RL ROTARY DIMMER (600 W)
2100 444 02XX	IŞIKLI DİMMER (1000 W)	RL ROTARY DIMMER (1000 W)
2100 447 02XX	RC DİMMER (325 W)	RC DIMMER (325 W)
<b>ELEKTRONİK GRUBU</b>		<b>ELECTRONIC GROUP</b>
2100 450 01XX	ENERGY SAVER GECİKMESİZ IŞIKLI	ENERGY SAVER ILLUMINATED
2100 452 01XX	ENERGY SAVER GECİKMELİ IŞIKLI	ENERGY SAVER WITH DELAY
2100 470 02XX	MÜZİK YAYIN ANAHTARI	AUDIO SWITCH
2100 480 01XX	HOPARLÖR PRİZİ	SPEAKER SOCKET
2100 485 02XX	UYARI ZİLİ	WARNING SWITCH
2100 495 02XX	HAREKET SENSÖRÜ	MOVEMENT SENSOR
<b>PRİZ GRUBU</b>		<b>SOCKET GROUP</b>
2100 600 02XX	TOPRAKLI PRİZ	EARTHED SOCKET OUTLET
2100 601 02XX	TOPRAKSIZ PRİZ	SOCKET OUTLET NON- EARTHED
2100 605 02XX	TOPRAKLI PRİZ (ÇOCUK KORUMALI)	EARTHED SOCKET WITH CHILD PROTECTION
2100 606 02XX	TOPRAKSIZ PRİZ (ÇOCUK KORUMALI)	SOCKET OUTLET WITH CHILD PROTECTION NON EARTHED
2100 610 02XX	KAPAKLI TOPRAKLI PRİZ	EARTHED SOCKET WITH COVER
2100 611 02XX	KAPAKLI TOPRAKLI PRİZ (ÇOCUK KORUMALI)	EARTHED SOCKET WITH CHILD PROTECTION COVER
2100 615 02XX	UPS (FRANSIZ) PRİZİ	UPS (FRENCH) SOCKET (EARTHED SOCKET WITH PIN)
2100 616 02XX	UPS (FRANSIZ) PRİZİ (ÇOCUK KORUMALI)	UPS (FRENCH) SOCKET (CHILD PROTECTION)
2100 617 02XX	UPS KAPAKLI(FRANSIZ) PRİZİ	UPS SOCKET (FRENCH) WITH COVER
2100 618 02XX	UPS (FRANSIZ)KAP. TOPRAKLI PRİZ (ÇOC.KRM)	UPS SOCKET (FRENCH) WITH COVER (CHILD PROTECTION)
2100 200 02XX	İKİLİ TOPRAKLI PRİZ (PORSELEN)	DOUBLE SOCKET EARTHED PORCELAIN
2100 201 02XX	İKİLİ TOPRAKSIZ PRİZ (PORSELEN)	DOUBLE SOCKET (NON EARTHED) PORCELAIN
2100 202 02XX	İKİLİ TOPRAKLI PRİZ	DOUBLE SOCKET EARTHED
2100 203 02XX	İKİLİ TOPRAKSIZ PRİZ	DOUBLE SOCKET (NON EARTHED)
2100 215 02XX	İKİLİ UPS PRİZ	DOUBLE SOCKET WITH UPS (FRENCH)
2100 448 02XX	TEKLİ USB ŞARJ PRİZİ	USB CHARGE SOCKET
2100 449 02XX	İKİLİ USB ŞARJ PRİZİ	USB CHARGE TWO SOCKET
2100 469 02XX	İKİLİ USB + TYPE-C ŞARJ PRİZİ	2*USB +TYPE-C CHARGER
<b>İLETİŞİM GRUBU</b>		<b>COMMUNICATIONS GROUP</b>
2100 125 01XX	TELEFON PRİZİ 1*RJ12 (CAT 3)	TELEPHONE SOCKET 1*RJ12 (CAT 3)
2100 126 01XX	TELEFON PRİZİ 2*RJ12 (CAT 3)	TELEPHONE SOCKET 2*RJ12 (CAT 3)
2100 128 01XX	ETİKETLİ TELEFON DATA PRİZ (KON.SÜZ)	TELEPHONE DATA SOCKET WITH LABEL (WITHOUT CONNECTOR)
2100 135 01XX	DATA PRİZ 1*RJ45 (KONNEKTÖRSÜZ)	DATA SOCKET 1*RJ45 (WITHOUT CONNECTOR)
2100 136 01XX	DATA PRİZ 1*RJ45 (CAT 5E)	DATA SOCKET 1*RJ45 (CAT 5E)
2100 137 01XX	DATA PRİZ 2*RJ45 (KONNEKTÖRSÜZ)	DATA SOCKET 2*RJ45 (WITHOUT CONNECTOR)
2100 138 01XX	DATA PRİZ 2*RJ45 (CAT 5E)	DATA SOCKET 2*RJ45 (CAT 5E)
2100 139 01XX	DATA PRİZ (RJ12 CAT 3+CAT 5 E)	DATA SOCKET (RJ12 CAT 3+CAT 5 E)
2100 140 01XX	DATA PRİZ 1*RJ45 (CAT 6)	DATA SOCKET 1*RJ45 (CAT 6)
2100 141 01XX	DATA PRİZ 2*RJ45 (CAT 6)	DATA SOCKET 2*RJ45 (CAT 6)
2100 455 01XX	DATA PRİZ 1*USB	DATA SOCKET 1* USB
2100 456 01XX	DATA PRİZ 2*USB	DATA SOCKET 2* USB
2100 457 01XX	DATA PRİZ 1*HDMI	DATA SOCKET 1*HDMI
2100 458 01XX	DATA PRİZ 2*HDMI	DATA SOCKET 2*HDMI
2100 459 01XX	DATA PRİZ 1*USB / 1*HDMI	DATA SOCKET 1*USB / 1*HDMI
2100 460 01XX	VGA PRİZ	VGA SOCKET
2100 121 02XX	KÖR KAPAK	BLIND COVER
<b>TV / SAT GRUBU</b>		<b>TV / SAT GROUP</b>
2100 156 02XX	TV / SAT PRİZİ (GEÇİŞLİ) 4DB/F KON.	TV / SAT SOCKET (THROUGH) 4DB/F CON.
2100 157 02XX	TV / SAT PRİZİ (SONLU)	TV / SAT SOCKET (DEAD-END)
2100 166 01XX	SAT PRİZİ (GEÇİŞLİ) 4DB/F KON.	SAT SOCKET (THROUGH)
2100 167 01XX	SAT PRİZİ (SONLU)	SAT SOCKET (DEAD-END)
2100 170 01XX	TV PRİZİ (GEÇİŞLİ) 11 DB	TV SOCKET (THROUGH) 11 DB
2100 171 01XX	TV PRİZİ (SONLU)	TV SOCKET (DEAD-END)
2100 172 01XX	TV PRİZİ F Dişi	TV SOCKET F FEMALE
<b>İNGİLİZ TİPİ ANAHTAR PRİZ</b>		<b>BRITISH TYPE SWITCH SOCKET</b>
2190 500 02XX	İNGİLİZ TİP ANAHTARLI PRİZ	BRITISH TYPE SWITCH SOCKET
<b>SIVA ÜSTÜ KASA</b>		<b>SURFACE BOX</b>
2100 000 11XX	SIVA ÜSTÜ KASA	SURFACE MOUNTED BOX
2200 000 0001	KTP IP44 PRİZ CONTA	SOCKET GASKET

# Nemliyer

SERİSİ  
SERIES



Islak mekanlar için güvenliği artırılmış IP44 koruma sınıfında.  
Naturel ve ahşap renk seçenekleriyle sıva üstü anahtar  
uygulamalarının vazgeçilmez ürünleri.

40



# SIVA ÜSTÜ • SURFACE

For wet places  
security-enhanced IP44  
protection class.  
Indispensable products  
for surface switch appli-  
cations with natural and  
wood color choices...



# Nemliyer

TEKNİK BİLGİLER  
TECHNICAL FEATURES

IP44

## BOYUTLAR • DIMENSIONS

Tuşlu ürün ölçüleri • Product dimensions with switch

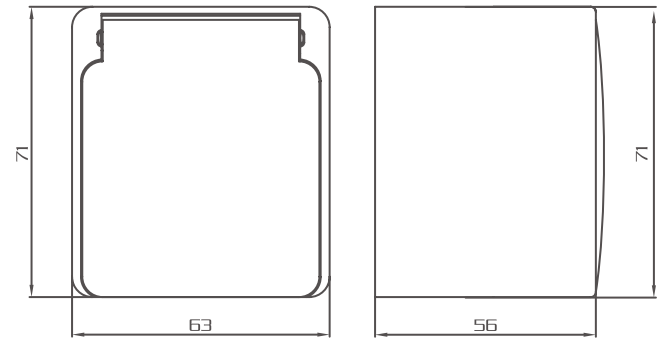
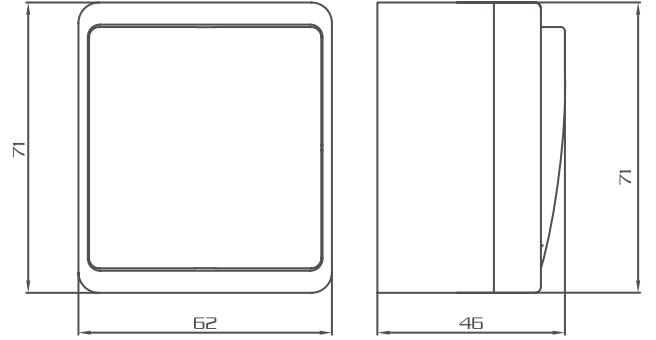

Soketli ürün ölçüleri • Socket product dimensions

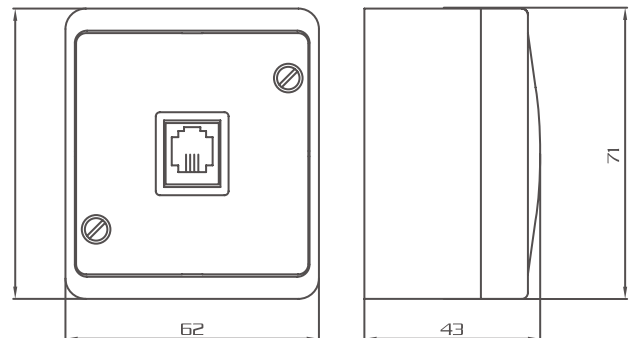

## ÜRÜN LİSTESİ • PRODUCT LIST

Kod / Code	Ürün Tanımı	Description
2150 301 01XX	ANAHTAR	ONE GANG ONE WAY SWITCH
2150 302 01XX	KOMİTATÖR	TWO GANG ONE WAY SWITCH
2150 303 01XX	VAVİEN	ONE GANG TWO WAY SWITCH (VEAVIEN)
2150 305 01XX	ÇİFT KUTUPLU ANAHTAR	DOUBLE POLE SWITCH
2150 307 01XX	LİGHİT (ÇAĞIRMA)	ONE GANG ONE WAY CONTROL SWITCH
2150 110 02XX	KAPAKLI TOPRAKLI PRİZ	EARTHED SOCKET WITH COVER
2150 115 02XX	KAPAKLI UPS (FRANSIZ) PRİZ	UPS (FRENCH) SOCKET WITH COVER
2150 125 02XX	TELEFON PRİZİ 1*RJ12 (Cat3)	TELEPHONE SOCKET 1*RJ12 (Cat3)
2150 136 01XX	DATA PRİZİ 1*RJ45 (Cat5e)	DATA SOCKET 1*RJ45 (Cat5e)
2150 166 02XX	SAT PRİZİ (GEÇİŞLİ)	SAT SOCKET (THROUGH)
2150 167 02XX	SAT PRİZİ (SONLU)	SAT SOCKET (DEAD-END)
2150 170 02XX	TV PRİZİ (GEÇİŞLİ)	TV SOCKET (THROUGH)
2150 171 02XX	TV PRİZİ (SONLU)	TV SOCKET (DEAD-END)

## RENK SEÇENEKLERİ • COLOR OPTIONS



XX : 01 Beyaz • White

XX : 03 Gri • Grey



XX : 40 Açık Kayın • Light Beech

XX : 41 Koyu Ceviz • Dark Walnuts

XX : 43 Merbau

XX : 44 Maun • Mahogany

XX : 44 Armut • Pear



## Sıva üstü uygulamalarda sorunsuz işlevsel çözümler...

Duvarlarda zarif dokunuşların izini sürün.  
Hem şık hem işlevsel ürünlerin hazzını yaşayın.

## Hassle-free functional solutions in surface switch applications...

Follow the elegant touches on the walls. Enjoy the pleasures of both stylish and functional products.



# Bron

TEKNİK BİLGİLER  
TECHNICAL FEATURES

## BOYUTLAR • DIMENSIONS

**Tuşlu ürün ölçüleri • Product dimensions with switch**

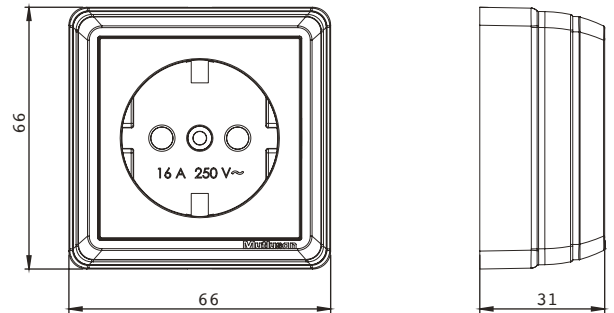
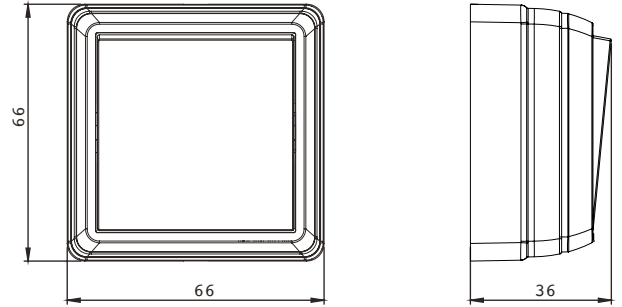

**Soketli ürün ölçüleri • Socket product dimensions**

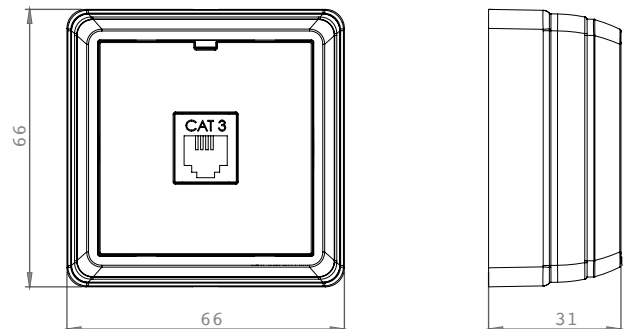



**ÜRÜN LİSTESİ • PRODUCT LIST**

Kod / Code	Ürün Tanımı	Description
2160 301 02XX	ANAHTAR	ONE GANG ONE WAY SWITCH
2160 302 02XX	KOMİTATÖR	TWO GANG ONE WAY SWITCH
2160 303 02XX	VAVİEN	ONE GANG TWO WAY SWITCH (VEAVİEN)
2160 307 02XX	LIGHT (ÇAĞIRMA)	ONE GANG ONE WAY CONTROL SWITCH
2160 315 02XX	IŞIKLI ANAHTAR (220V)	ILLUMINATED ONE GANG ONE WAY SWITCH (220V)
2160 316 02XX	IŞIKLI VAVİEN (220V)	ILLUMINATED ONE GANG TWO WAY SWITCH (220V) (VEAVİEN)
2160 317 02XX	IŞIKLI LIGHT (ÇAĞIRMA) (220V)	ILLUMINATED ONE GANG ONE WAY CONTROL SWITCH (220V)
2160 326 02XX	IŞIKLI KOMİTATÖR	ILLUMINATED TWO GANG ONE WAY SWITCH (220V)
2160 100 02XX	TOPRAKLI PRİZ	SOCKET OUTLET WITH EARTHED CONTACT (EARTHED SOCKET)
2160 101 02XX	TOPRAKSIZ PRİZ	SOCKET OUTLET
2160 103 02XX	TOPRAKLI PRİZ PORSELEN	SOCKET OUTLET WITH EARTHED CONTACT (EARTHED SOCKET) PORCELAIN
2160 104 02XX	TOPRAKSIZ PRİZ PORSELEN	SOCKET OUTLET PORCELAIN
2160 110 02XX	KAPAKLI TOPRAKLI PRİZ	EARTHED SOCKET WITH COVER
2160 113 02XX	KAPAKLI TOPRAKLI PRİZ PORSELEN	EARTHED SOCKET WITH COVER PORCELAIN
2160 115 02XX	UPS (FRANSIZ) PRİZ	UPS (FRENCH) SOCKET (EARTHED SOCKET WITH PIN)
2160 125 02XX	TELEFON PRİZİ 1*RJ12	TELEPHONE SOCKET 1*RJ12 (CAT3)
2160 136 02XX	DATA PRİZİ 1*RJ45 (CAT5)	DATA SOCKET 1*RJ45 (CAT5)
2160 166 02XX	SAT PRİZİ (GEÇİŞLİ) 4DB/F KONNEKTÖR	SAT SOCKET (THROUGH) 4DB/F CONNECTOR
2160 167 02XX	SAT PRİZİ (SONLU)	SAT SOCKET (DEAD-END)
2160 170 02XX	TV PRİZİ (GEÇİŞLİ)	TV SOCKET (THROUGH)
2160 171 02XX	TV PRİZİ (SONLU)	TV SOCKET (DEAD-END)
2160 200 02XX	İKİLİ TOPRAKLI PRİZ PORSELEN	TWO SOCKET OUTLET WITH EARTHED CONTACT (EARTHED SOCKET) PORCELAIN
2160 201 02XX	İKİLİ TOPRAKSIZ PRİZ PORSELEN	TWO SOCKET OUTLET PORCELAIN
2160 202 02XX	İKİLİ TOPRAKLI PRİZ	TWO SOCKET OUTLET WITH EARTHED CONTACT (EARTHED SOCKET)
2160 203 02XX	İKİLİ TOPRAKSIZ PRİZ	TWO SOCKET OUTLET
2160 215 02XX	İKİLİ UPS (FRANSIZ) PRİZ	UPS DOUBLE (FRENCH) OUTLET

**RENK SEÇENEKLERİ • COLOR OPTIONS**

XX : 01 Beyaz • White



XX : 02 Krem • Ivory



XX : 57 Ceviz • Walnuts



XX : 58 Meşe • Oak



Ri-tech

Olimpia

Aksesuarlar • Accessories



**GRUP PRİZLER**  
GROUP SOCKETS

## ANAHTARLI ÇOCUK KORUMALI KOLAY BAĞLANTILI GRUP PRİZLER

Sadece kolay bağlantı kapağını açarak, kablo bağlantıları yapılabilen (priz kontak modülü kısmı açılmayan), herhangi bir yüzeye sabitlenebilme yada asılabilir olarak kullanılabilme özellikleri ile evde , ofiste vb. yerlerde çocuk koruma özelliği ile güvenlik ve konforu bir arada sunuyor. Anahtarın içindeki mavi ışıkla estetikliğini süslüyor.

### Askı Aparatı Hanging Kit

### USB Şarj Priz USB Socket (5V 2.1A)

### Kolay Bağlantı Easy Connection

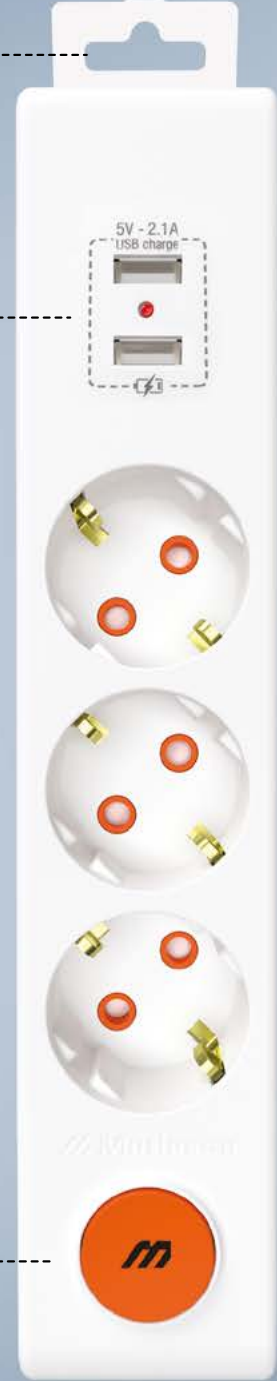

# Group Sockets

GRUP PRİZLER • GROUP SOCKETS

## KEY PROTECTION WITH SWITCH EASY CONNECTED GROUP SOCKETS

Cable connections simply by opening the easy connection cover can be mounted (socket contact module part can not be opened), can be fixed to any surface or can be used with the ability to hang at home, office, etc. offers a combination of safety and comfort with child protection. It embellishes its aesthetics with the blue light inside the key.

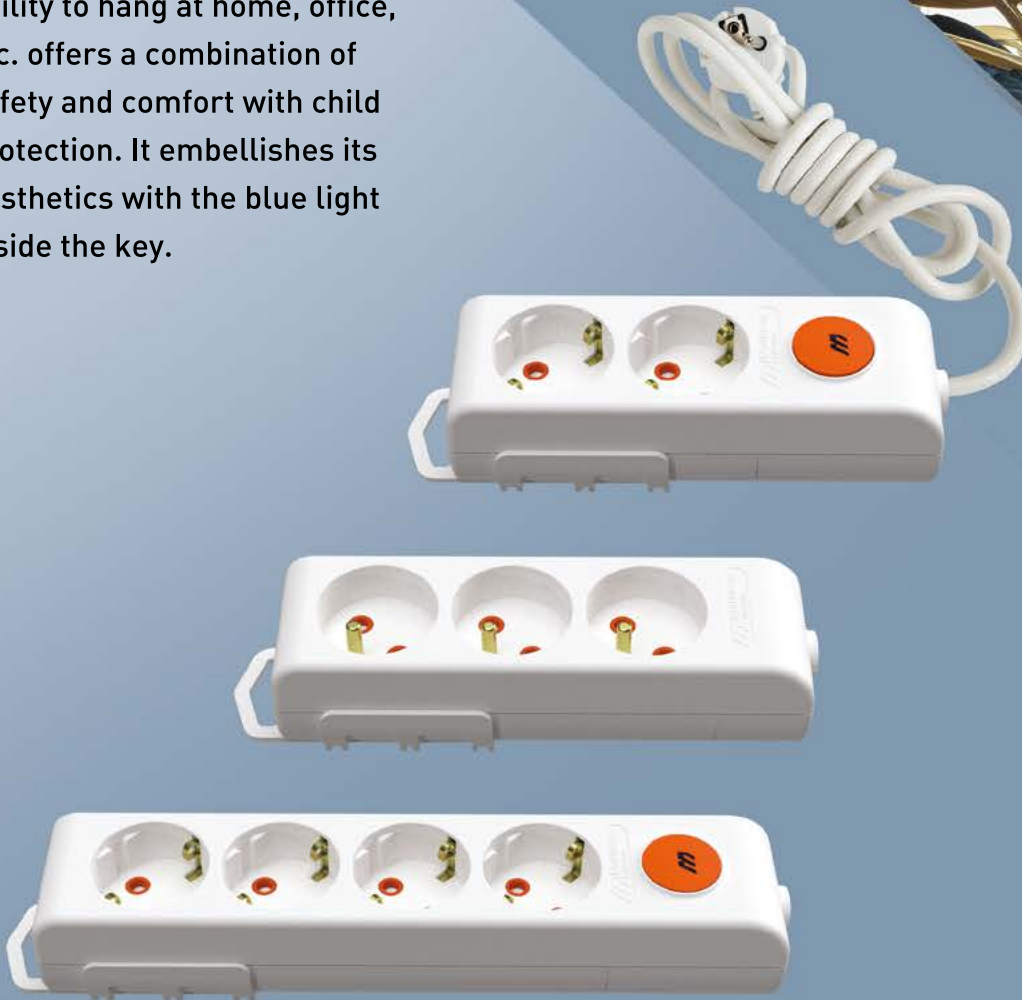

Anahtarlı, anahtarsız, UPS, kablolu, klemensli, ikili, üçlü, dördlü, altılı seçenekleriyle taşınabilir enerji ihtiyaçlarınızı karşılayacak.

It will meet your portable energy needs with key / keyless switch, UPS, wired, terminal, two gang, three gang, four gang, six gang options.



Kod / Code	Ürün Tanımı	Descriptions
001 175 210001 00 00	İKİLİ TOP.LI GRUP PRİZ(Ç.K.)(KLEMENSLİ)	2 GANG EARTHED GROUP SOCKET(CHILD PROTEC.)(W/OUT CABLE)
001 175 210002 01 00	İKİLİ TOP.LI GRUP PRİZ(Ç.K.)(1 MT)	2 GANG EARTHED GROUP SOCKET(CHILD PROTEC.)(1 MT)
001 175 210002 02 00	İKİLİ TOP.LI GRUP PRİZ(Ç.K.)(2 MT)	2 GANG EARTHED GROUP SOCKET(CHILD PROTEC.)(2 MT)
001 175 210002 03 00	İKİLİ TOP.LI GRUP PRİZ(Ç.K.)(3 MT)	2 GANG EARTHED GROUP SOCKET(CHILD PROTEC.)(3 MT)
001 175 210002 05 00	İKİLİ TOP.LI GRUP PRİZ(Ç.K.)(5 MT)	2 GANG EARTHED GROUP SOCKET(CHILD PROTEC.)(5 MT)
001 175 220001 00 00	İKİLİ ANAHT. TOP.LI GRUP PRİZ(Ç.K.)(KLEMENSLİ)	2 GANG EARTHED GROUP SOCKET(CHILD PROTEC.)(W/OUT CABLE+SWITCH)
001 175 220002 01 00	İKİLİ ANAHT. TOP.LI GRUP PRİZ(Ç.K.)(1 MT)	2 GANG EARTHED GROUP SOCKET(CHILD PROTEC.)(WITH SWITCH)(1 MT)
001 175 220002 02 00	İKİLİ ANAHT. TOP.LI GRUP PRİZ(Ç.K.)(2 MT)	2 GANG EARTHED GROUP SOCKET(CHILD PROTEC.)(WITH SWITCH)(2 MT)
001 175 220002 03 00	İKİLİ ANAHT. TOP.LI GRUP PRİZ(Ç.K.)(3 MT)	2 GANG EARTHED GROUP SOCKET(CHILD PROTEC.)(WITH SWITCH)(3 MT)
001 175 220002 05 00	İKİLİ ANAHT. TOP.LI GRUP PRİZ(Ç.K.)(5 MT)	2 GANG EARTHED GROUP SOCKET(CHILD PROTEC.)(WITH SWITCH)(5 MT)
001 175 310001 00 00	ÜÇLÜ TOP.LI GRUP PRİZ(Ç.K.)(KLEMENSLİ)	3 GANG EARTHED GROUP SOCKET(CHILD PROTEC.)(W/OUT CABLE)
001 175 310002 01 00	ÜÇLÜ TOP.LI GRUP PRİZ(Ç.K.)(1 MT)	3 GANG EARTHED GROUP SOCKET(CHILD PROTEC.)(1 MT)
001 175 310002 02 00	ÜÇLÜ TOP.LI GRUP PRİZ(Ç.K.)(2 MT)	3 GANG EARTHED GROUP SOCKET(CHILD PROTEC.)(2 MT)
001 175 310002 03 00	ÜÇLÜ TOP.LI GRUP PRİZ(Ç.K.)(3 MT)	3 GANG EARTHED GROUP SOCKET(CHILD PROTEC.)(3 MT)
001 175 310002 05 00	ÜÇLÜ TOP.LI GRUP PRİZ(Ç.K.)(5 MT)	3 GANG EARTHED GROUP SOCKET(CHILD PROTEC.)(5 MT)
001 175 320001 00 00	ÜÇLÜ ANAHT. TOP.LI GRUP PRİZ(Ç.K.)(KLEMENSLİ)	3 GANG EARTHED GROUP SOCKET(CHILD PROTEC.)(W/OUT CABLE+SWITCH)
001 175 320002 01 00	ÜÇLÜ ANAHT. TOP.LI GRUP PRİZ(Ç.K.)(1 MT)	3 GANG EARTHED GROUP SOCKET(CHILD PROTEC.)(WITH SWITCH)(1 MT)
001 175 320002 02 00	ÜÇLÜ ANAHT. TOP.LI GRUP PRİZ(Ç.K.)(2 MT)	3 GANG EARTHED GROUP SOCKET(CHILD PROTEC.)(WITH SWITCH)(2 MT)
001 175 320002 03 00	ÜÇLÜ ANAHT. TOP.LI GRUP PRİZ(Ç.K.)(3 MT)	3 GANG EARTHED GROUP SOCKET(CHILD PROTEC.)(WITH SWITCH)(3 MT)
001 175 320002 05 00	ÜÇLÜ ANAHT. TOP.LI GRUP PRİZ(Ç.K.)(5 MT)	3 GANG EARTHED GROUP SOCKET(CHILD PROTEC.)(WITH SWITCH)(5 MT)
001 175 350001 00 00	ÜÇLÜ USB ANAHT. TOP.LI GRUP PRİZ(Ç.K.)(KLEMENSLİ)	3 GANG USB EARTHED GROUP SOCKET(CHILD PROTEC.)(W/OUT CABLE+SWITCH)
001 175 350002 02 00	ÜÇLÜ USB ANAHT. TOP.LI GRUP PRİZ(Ç.K.)(2 MT)	3 GANG USB EARTHED GROUP SOCKET(CHILD PROTEC.)(WITH SWITCH)(2 MT)
001 175 350002 03 00	ÜÇLÜ USB ANAHT. TOP.LI GRUP PRİZ(Ç.K.)(3 MT)	3 GANG USB EARTHED GROUP SOCKET(CHILD PROTEC.)(WITH SWITCH)(3 MT)
001 175 350002 05 00	ÜÇLÜ USB ANAHT. TOP.LI GRUP PRİZ(Ç.K.)(5 MT)	3 GANG USB EARTHED GROUP SOCKET(CHILD PROTEC.)(WITH SWITCH)(5 MT)
001 175 410001 00 00	DÖRTLÜ TOP.LI GRUP PRİZ(Ç.K.)(KLEMENSLİ)	4 GANG EARTHED GROUP SOCKET(CHILD PROTEC.)(W/OUT CABLE)
001 175 410002 01 00	DÖRTLÜ TOP.LI GRUP PRİZ(Ç.K.)(1 MT)	4 GANG EARTHED GROUP SOCKET(CHILD PROTEC.)(1 MT)
001 175 410002 02 00	DÖRTLÜ TOP.LI GRUP PRİZ(Ç.K.)(2 MT)	4 GANG EARTHED GROUP SOCKET(CHILD PROTEC.)(2 MT)
001 175 410002 03 00	DÖRTLÜ TOP.LI GRUP PRİZ(Ç.K.)(3 MT)	4 GANG EARTHED GROUP SOCKET(CHILD PROTEC.)(3 MT)
001 175 410002 05 00	DÖRTLÜ TOP.LI GRUP PRİZ(Ç.K.)(5 MT)	4 GANG EARTHED GROUP SOCKET(CHILD PROTEC.)(5 MT)
001 175 420001 00 00	DÖRTLÜ ANAHT. TOP.LI GRUP PRİZ(Ç.K.)(KLEMENSLİ)	4 GANG EARTHED GROUP SOCKET(CHILD PROTEC.)(W/OUT CABLE+ SWITCH)
001 175 420002 01 00	DÖRTLÜ ANAHT. TOP.LI GRUP PRİZ(Ç.K.)(1 MT)	4 GANG EARTHED GROUP SOCKET(CHILD PROTEC.)(WITH SWITCH)(1 MT)
001 175 420002 02 00	DÖRTLÜ ANAHT. TOP.LI GRUP PRİZ(Ç.K.)(2 MT)	4 GANG EARTHED GROUP SOCKET(CHILD PROTEC.)(WITH SWITCH)(2 MT)
001 175 420002 03 00	DÖRTLÜ ANAHT. TOP.LI GRUP PRİZ(Ç.K.)(3 MT)	4 GANG EARTHED GROUP SOCKET(CHILD PROTEC.)(WITH SWITCH)(3 MT)
001 175 420002 05 00	DÖRTLÜ ANAHT. TOP.LI GRUP PRİZ(Ç.K.)(5 MT)	4 GANG EARTHED GROUP SOCKET(CHILD PROTEC.)(WITH SWITCH)(5 MT)
001 175 610001 00 00	ALTILI TOP.LI GRUP PRİZ(Ç.K.)(KLEMENSLİ)	6 GANG EARTHED GROUP SOCKET(CHILD PROTEC.)(W/OUT CABLE)
001 175 610002 01 00	ALTILI TOP.LI GRUP PRİZ(Ç.K.)(1 MT)	6 GANG EARTHED GROUP SOCKET(CHILD PROTEC.)(1 MT)
001 175 610002 02 00	ALTILI TOP.LI GRUP PRİZ(Ç.K.)(2 MT)	6 GANG EARTHED GROUP SOCKET(CHILD PROTEC.)(2 MT)
001 175 610002 03 00	ALTILI TOP.LI GRUP PRİZ(Ç.K.)(3 MT)	6 GANG EARTHED GROUP SOCKET(CHILD PROTEC.)(3 MT)
001 175 610002 05 00	ALTILI TOP.LI GRUP PRİZ(Ç.K.)(5 MT)	6 GANG EARTHED GROUP SOCKET(CHILD PROTEC.)(5 MT)
001 175 620001 00 00	ALTILI ANAHT. TOP.LI GRUP PRİZ(Ç.K.)(KLEMENSLİ)	6 GANG EARTHED GROUP SOCKET(CHILD PROTEC.)(W/OUT CABLE+SWITCH)
001 175 620002 01 00	ALTILI ANAHT. TOP.LI GRUP PRİZ(Ç.K.)(1 MT)	6 GANG EARTHED GROUP SOCKET(CHILD PROTEC.)(WITH SWITCH)(1 MT)
001 175 620002 02 00	ALTILI ANAHT. TOP.LI GRUP PRİZ(Ç.K.)(2 MT)	6 GANG EARTHED GROUP SOCKET(CHILD PROTEC.)(WITH SWITCH)(2 MT)
001 175 620002 03 00	ALTILI ANAHT. TOP.LI GRUP PRİZ(Ç.K.)(3 MT)	6 GANG EARTHED GROUP SOCKET(CHILD PROTEC.)(WITH SWITCH)(3 MT)
001 175 620002 05 00	ALTILI ANAHT. TOP.LI GRUP PRİZ(Ç.K.)(5 MT)	6 GANG EARTHED GROUP SOCKET(CHILD PROTEC.)(WITH SWITCH)(5 MT)
001 175 650001 00 00	ALTILI USB ANAHT. TOP.LI GRUP PRİZ(Ç.K.)(KLEMENSLİ)	6 GANG USB EARTHED GROUP SOCKET(CHILD PROTEC.)(W/OUT CABLE+SWITCH)
001 175 650002 02 00	ALTILI USB ANAHT. TOP.LI GRUP PRİZ(Ç.K.)(2 MT)	6 GANG USB EARTHED GROUP SOCKET(CHILD PROTEC.)(WITH SWITCH)(2 MT)
001 175 650002 03 00	ALTILI USB ANAHT. TOP.LI GRUP PRİZ(Ç.K.)(3 MT)	6 GANG USB EARTHED GROUP SOCKET(CHILD PROTEC.)(WITH SWITCH)(3 MT)
001 175 650002 05 00	ALTILI USB ANAHT. TOP.LI GRUP PRİZ(Ç.K.)(5 MT)	6 GANG USB EARTHED GROUP SOCKET(CHILD PROTEC.)(WITH SWITCH)(5 MT)
001 175 330001 00 00	ÜÇLÜ UPS GRUP PRİZ(Ç.K.)(KLEMENSLİ)	3 GANG UPS GROUP SOCKET(CHILD PROTEC.)(W/OUT CABLE)
001 175 330002 02 00	ÜÇLÜ UPS GRUP PRİZ(Ç.K.)(2 MT)	3 GANG UPS GROUP SOCKET(CHILD PROTEC.)(2 MT)
001 175 330002 03 00	ÜÇLÜ UPS GRUP PRİZ(Ç.K.)(3 MT)	3 GANG UPS GROUP SOCKET(CHILD PROTEC.)(3 MT)
001 175 330002 05 00	ÜÇLÜ UPS GRUP PRİZ(Ç.K.)(5 MT)	3 GANG UPS GROUP SOCKET(CHILD PROTEC.)(5 MT)
001 175 340001 00 00	ÜÇLÜ ANAHT. UPS GRUP PRİZ(Ç.K.)(KLEMENSLİ)	3 GANG UPS GROUP SOCKET(CHILD PROTEC.)(W/OUT CABLE+SWITCH)
001 175 340002 02 00	ÜÇLÜ ANAHT. UPS GRUP PRİZ(Ç.K.)(2 MT)	3 GANG UPS GROUP SOCKET(CHILD PROTEC.)(WITH SWITCH)(2 MT)
001 175 340002 03 00	ÜÇLÜ ANAHT. UPS GRUP PRİZ(Ç.K.)(3 MT)	3 GANG UPS GROUP SOCKET(CHILD PROTEC.)(WITH SWITCH)(3 MT)
001 175 340002 05 00	ÜÇLÜ ANAHT. UPS GRUP PRİZ(Ç.K.)(5 MT)	3 GANG UPS GROUP SOCKET(CHILD PROTEC.)(WITH SWITCH)(5 MT)
001 175 430001 00 00	DÖRTLÜ UPS GRUP PRİZ(Ç.K.)(KLEMENSLİ)	4 GANG UPS GROUP SOCKET(CHILD PROTEC.)(W/OUT CABLE)
001 175 430002 02 00	DÖRTLÜ UPS GRUP PRİZ(Ç.K.)(2 MT)	4 GANG UPS GROUP SOCKET(CHILD PROTEC.)(2 MT)
001 175 430002 03 00	DÖRTLÜ UPS GRUP PRİZ(Ç.K.)(3 MT)	4 GANG UPS GROUP SOCKET(CHILD PROTEC.)(3 MT)
001 175 430002 05 00	DÖRTLÜ UPS GRUP PRİZ(Ç.K.)(5 MT)	4 GANG UPS GROUP SOCKET(CHILD PROTEC.)(5 MT)

Kod / Code	Ürün Tanımı	Descriptions
001 175 440001 00 00	DÖRTLÜ ANAHT. UPS GRUP PRİZ(Ç.K.)(KLEMENSLİ)	4 GANG UPS GROUP SOCKET(CHILD PROTEC.)(W/OUT CABLE+ SWITCH)
001 175 440002 02 00	DÖRTLÜ ANAHT. UPS GRUP PRİZ(Ç.K.)(2 MT)	4 GANG UPS GROUP SOCKET(CHILD PROTEC.)(WITH SWITCH)(2 MT)
001 175 440002 03 00	DÖRTLÜ ANAHT. UPS GRUP PRİZ(Ç.K.)(3 MT)	4 GANG UPS GROUP SOCKET(CHILD PROTEC.)(WITH SWITCH)(3 MT)
001 175 440002 05 00	DÖRTLÜ ANAHT. UPS GRUP PRİZ(Ç.K.)(5 MT)	4 GANG UPS GROUP SOCKET(CHILD PROTEC.)(WITH SWITCH)(5 MT)
001 175 630001 00 00	ALTILI UPS GRUP PRİZ(Ç.K.)(KLEMENSLİ)	6 GANG UPS GROUP SOCKET(CHILD PROTEC.)(W/OUT CABLE)
001 175 630002 02 00	ALTILI UPS GRUP PRİZ(Ç.K.)(2 MT)	6 GANG UPS GROUP SOCKET(CHILD PROTEC.)(2 MT)
001 175 630002 03 00	ALTILI UPS GRUP PRİZ(Ç.K.)(3 MT)	6 GANG UPS GROUP SOCKET(CHILD PROTEC.)(3 MT)
001 175 630002 05 00	ALTILI UPS GRUP PRİZ(Ç.K.)(5 MT)	6 GANG UPS GROUP SOCKET(CHILD PROTEC.)(5 MT)
001 175 640001 00 00	ALTILI ANAHT. UPS GRUP PRİZ(Ç.K.)(KLEMENSLİ)	6 GANG UPS GROUP SOCKET(CHILD PROTEC.)(W/OUT CABLE+ SWITCH)
001 175 640002 02 00	ALTILI ANAHT. UPS GRUP PRİZ(Ç.K.)(2 MT)	6 GANG UPS GROUP SOCKET(CHILD PROTEC.)(WITH SWITCH)(2 MT)
001 175 640002 03 00	ALTILI ANAHT. UPS GRUP PRİZ(Ç.K.)(3 MT)	6 GANG UPS GROUP SOCKET(CHILD PROTEC.)(WITH SWITCH)(3 MT)
001 175 640002 05 00	ALTILI ANAHT. UPS GRUP PRİZ(Ç.K.)(5 MT)	6 GANG UPS GROUP SOCKET(CHILD PROTEC.)(WITH SWITCH)(5 MT)
001 175 390001 00 00	ÜÇLÜ TOPRAKSIZ GRUP PRİZ(Ç.K.)(KLEMENSLİ)	3 GANG NON EARTHED GROUP SOCKET(W/OUT CABLE)
001 175 390002 02 00	ÜÇLÜ TOPRAKSIZ GRUP PRİZ(Ç.K.)(2 MT)	3 GANG NON EARTHED GROUP SOCKET OUTLET (2 MT) CABLE
001 175 390002 03 00	ÜÇLÜ TOPRAKSIZ GRUP PRİZ(Ç.K.)(3 MT)	3 GANG NON EARTHED GROUP SOCKET OUTLET (3 MT) CABLE
001 175 390002 05 00	ÜÇLÜ TOPRAKSIZ GRUP PRİZ(Ç.K.)(5 MT)	3 GANG NON EARTHED GROUP SOCKET OUTLET (5 MT) CABLE
001 175 390002 07 00	ÜÇLÜ TOPRAKSIZ GRUP PRİZ(Ç.K.)(7 MT)	3 GANG NON EARTHED GROUP SOCKET OUTLET (7 MT) CABLE
001 175 390002 10 00	ÜÇLÜ TOPRAKSIZ GRUP PRİZ(Ç.K.)(10 MT)	3 GANG NON EARTHED GROUP SOCKET OUTLET (10 MT) CABLE
001 175 392001 00 00	ÜÇLÜ ANAHT. TOP.SIZ GRUP PRİZ (Ç.K.) (KLEMENSLİ)	3 GANG NON EARTHED GROUP SOCKET(W/OUT CABLE)(WITH SWITCH)
001 175 392002 02 00	ÜÇLÜ ANAHT. TOP.SIZ GRUP PRİZ(Ç.K.)(2 MT)	3 GANG NON EARTHED GROUP SOCKET OUTLET 2 MT CORD (WITH SWITCH)
001 175 392002 03 00	ÜÇLÜ ANAHT. TOP.SIZ GRUP PRİZ(Ç.K.)(3 MT)	3 GANG NON EARTHED GROUP SOCKET OUTLET 3 MT CORD (WITH SWITCH)
001 175 392002 05 00	ÜÇLÜ ANAHT. TOP.SIZ GRUP PRİZ(Ç.K.)(5 MT)	3 GANG NON EARTHED GROUP SOCKET OUTLET 5 MT CORD (WITH SWITCH)
001 175 490001 00 00	DÖRTLÜ TOP.SIZ GRUP PRİZ(Ç.K.)(KLEMENSLİ)	4 GANG NON EARTHED GROUP SOCKET(W/OUT CABLE)
001 175 490002 02 00	DÖRTLÜ TOP.SIZ GRUP PRİZ(Ç.K.)(2 MT)	4 GANG NON EARTHED GROUP SOCKET OUTLET 2 MT CORD
001 175 490002 03 00	DÖRTLÜ TOP.SIZ GRUP PRİZ(Ç.K.)(3 MT)	4 GANG NON EARTHED GROUP SOCKET OUTLET 3 MT CORD
001 175 490002 05 00	DÖRTLÜ TOP.SIZ GRUP PRİZ(Ç.K.)(5 MT)	4 GANG NON EARTHED GROUP SOCKET OUTLET 5 MT CORD
001 175 492001 00 00	DÖRTLÜ ANAHT. TOP.SIZ GRUP PRİZ(Ç.K.)(KLEMENSLİ)	4 GANG NON EARTHED GROUP SOCKET(W/OUT CABLE)(WITH SWITCH)
001 175 492002 02 00	DÖRTLÜ ANAHT. TOP.SIZ GRUP PRİZ(Ç.K.)(2 MT)	4 GANG NON EARTHED GROUP SOCKET OUTLET (2 MT) CABLE (WITH SWITCH)
001 175 492002 03 00	DÖRTLÜ ANAHT. TOP.SIZ GRUP PRİZ(Ç.K.)(3 MT)	4 GANG NON EARTHED GROUP SOCKET OUTLET (3MT) CABLE (WITH SWITCH)
001 175 492002 05 00	DÖRTLÜ ANAHT. TOP.SIZ GRUP PRİZ(Ç.K.)(5 MT)	4 GANG NON EARTHED GROUP SOCKET OUTLET (5 MT) CABLE (WITH SWITCH)
001 175 690001 00 00	ALTILI TOP.SIZ GRUP PRİZ(Ç.K.)(KLEMENSLİ)	6 GANG NON EARTHED GROUP SOCKET(W/OUT CABLE)
001 175 690002 02 00	ALTILI TOP.SIZ GRUP PRİZ(Ç.K.)(2 MT)	6 GANG NON EARTHED GROUP SOCKET OUTLET (2 MT) CABLE
001 175 690002 03 00	ALTILI TOP.SIZ GRUP PRİZ(Ç.K.)(3 MT)	6 GANG NON EARTHED GROUP SOCKET OUTLET (3 MT) CABLE
001 175 690002 05 00	ALTILI TOP.SIZ GRUP PRİZ(Ç.K.)(5 MT)	6 GANG NON EARTHED GROUP SOCKET OUTLET (5 MT) CABLE
001 175 692001 00 00	ALTILI ANAHT. TOP.SIZ GRUP PRİZ(Ç.K.)(KLEMENSLİ)	6 GANG NON EARTHED GROUP SOCKET(W/OUT CABLE)(WITH SWITCH)
001 175 692002 02 00	ALTILI ANAHT. TOP.SIZ GRUP PRİZ(Ç.K.)(2 MT)	6 GANG NON EARTHED GROUP SOCKET OUTLET (2 MT) CABLE (WITH SWITCH)
001 175 692002 03 00	ALTILI ANAHT. TOP.SIZ GRUP PRİZ(Ç.K.)(3 MT)	6 GANG NON EARTHED GROUP SOCKET OUTLET (3 MT) CABLE (WITH SWITCH)
001 175 692002 05 00	ALTILI ANAHT. TOP.SIZ GRUP PRİZ(Ç.K.)(5 MT)	6 GANG NON EARTHED GROUP SOCKET OUTLET (5 MT) CABLE (WITH SWITCH)
001 175 350101 00 00	ÜÇLÜ USB+TYPE-C ANAHT. TOP.LI GRUP PRİZ(Ç.K.)(KLEMENSLİ)	3 GANG USB +TYPE-C EARTHED GROUP SOCKET(CHILD PRO.)W/OUT CABLE (WITH SWITCH)
001 175 350102 01 00	ÜÇLÜ USB+TYPE-C ANAHT. TOP.LI GRUP PRİZ(Ç.K.)(1 MT)	3 GANG USB +TYPE-C EARTHED GROUP SOCKET(CHILD PROT.) (1 MT) CABLE (WITH SWITCH)
001 175 350102 02 00	ÜÇLÜ USB+TYPE-C ANAHT. TOP.LI GRUP PRİZ(Ç.K.)(2 MT)	3 GANG USB +TYPE-C EARTHED GROUP SOCKET(CHILD PROT.) (2MT) CABLE (WITH SWITCH)
001 175 350102 03 00	ÜÇLÜ USB+TYPE-C ANAHT. TOP.LI GRUP PRİZ(Ç.K.)(3 MT)	3 GANG USB +TYPE-C EARTHED GROUP SOCKET(CHILD PROT.) (3MT) CABLE (WITH SWITCH)
001 175 350102 05 00	ÜÇLÜ USB+TYPE-C ANAHT. TOP.LI GRUP PRİZ(Ç.K.)(5 MT)	3 GANG USB +TYPE-C EARTHED GROUP SOCKET(CHILD PROT.) (5 MT) CABLE (WITH SWITCH)
001 175 650101 00 00	ALTILI USB+TYPE-C ANAHT. TOP.LI GRUP PRİZ(Ç.K.)(KLEMENSLİ)	6 GANG EARTHED GROUP SOCKET WITH USB+TYPE-C (WITH SWITCH AND CHILD PROTECTION (W/OUT CABLE)
001 175 650102 01 00	ALTILI USB+TYPE-C ANAHT. TOP.LI GRUP PRİZ(Ç.K.)(1 MT)	6 GANG EARTHED GROUP SOCKET WITH USB+TYPE-C (WITH SWITCH AND CHILD PROTECTION (1 MT CABLE)
001 175 650102 02 00	ALTILI USB+TYPE-C ANAHT. TOP.LI GRUP PRİZ(Ç.K.)(2 MT)	6 GANG EARTHED GROUP SOCKET WITH USB+TYPE-C (WITH SWITCH AND CHILD PROTECTION (2 MT CABLE)
001 175 650102 03 00	ALTILI USB+TYPE-C ANAHT. TOP.LI GRUP PRİZ(Ç.K.)(3 MT)	6 GANG EARTHED GROUP SOCKET WITH USB+TYPE-C (WITH SWITCH AND CHILD PROTECTION (3 MT CABLE)
001 175 650102 05 00	ALTILI USB+TYPE-C ANAHT. TOP.LI GRUP PRİZ(Ç.K.)(5 MT)	6 GANG EARTHED GROUP SOCKET WITH USB+TYPE-C (WITH SWITCH AND CHILD PROTECTION (5 MT CABLE)

## AKIM (ŞOK) KORUMALI GRUP PRİZ / CURRENT (SHOCK) PROTECTION GROUP SOCKET

001 175 660002 15 00	ALTILI ŞOK.KOR.USB ANHT. TOPLI GRUP PRİZ(Ç.K.)(3x1.5/1.5 MT)(1425 J)	6 GANG EARTHED GROUP SOCKET WITH CURRENT PROTECTION 2XUSB CHARGER WITH SWITCH AND CHILD PROTECTION WITH 1,5 MT CORD (1425 J)
001 175 660102 15 00	ALTILI ŞOK.KOR.USB+TYPE-C ANAHT. TOP.LI GRUP PR. (Ç.K.) (3x1.5 1.5 MT) (1425 J)	6 GANG EARTHED GROUP SOCKET WITH CURRENT PROTECTION 2xUSB CHARGER + TYPE C (WITH SWITCH AND CHILD PROTECTION WITH 1,5 MT CORD (1425 J)
001 175 670002 15 00	ALTILI ŞOK.KOR. ANAHT. TOPLI GRUP PRİZ(Ç.K.)(3x1.5 1.5 MT) (1425 J)	6 GANG EARTHED GROUP SOCKET WITH CURRENT PROTECTION WITH SWITCH AND CHILD PROTECTION WITH 1,5 MT CORD (1425 J)
001 888 100002 00 00	2'Li USB ŞARJ ADAPTÖR 2,4A	DOUBLE USB CHARGER ADAPTER 2.4A
001 888 100003 00 00	USB + TYPE-C ŞARJ ADAPTÖRÜ 2,4A	USB CHARGER +TYPE -C ADAPTER
001 888 100004 00 00	TEKLİ ŞOK KORUMALI PRİZ (625 J)	SINGLE CURRENT PROTECTION SOCKET (625 J)
001 888 100005 00 00	TEKLİ ŞOK KORUMALI 2 USB'Lİ PRİZ (625 J)	SINGLE CURRENT PROTECTION DOUBLE SOCKET (625 J)
001 888 100006 00 00	TEKLİ ŞOK KORUMALI USB + TYPE-C PRİZ (625 J)	SINGLE CURRENT PROTECTION +USB CHARGER (625 J)



Kod / Code	Ürün Tanımı	Descriptions
001 171 290001 00 00	İkili Topraksız Grup Priz (Klemensli) Olimpia	2 GANG GROUP SOCKET OUTLET CORDLESS
001 171 290002 02 00	İkili Topraksız Grup Priz (2Mt) Olimpia	2 GANG GROUP SOCKET (2 mt)
001 171 290002 03 00	İkili Topraksız Grup Priz (3Mt) Olimpia	2 GANG GROUP SOCKET (3 mt)
001 171 290002 05 00	İkili Topraksız Grup Priz (5Mt) Olimpia	2 GANG GROUP SOCKET (5 mt)
001 171 210001 00 00	İkili Topraklı Grup Priz (Klemensli) Olimpia	2 GANG EARTHED SOCKET (WITH TERMINAL)
001 171 210002 02 00	İkili Topraklı Grup Priz (2Mt) Olimpia	2 GANG EARTHED SOCKET OUTLET (2 mt cord)
001 171 210002 03 00	İkili Topraklı Grup Priz (3M) Olimpia	2 GANG EARTHED SOCKET OUTLET (3 mt cord)
001 171 210002 05 00	İkili Topraklı Grup Priz (5M) Olimpia	2 GANG EARTHED SOCKET OUTLET (5 mt cord)
001 171 390001 00 00	Üçlü Topraksız Grup Priz (Klemensli) Olimpia	3 GANG GROUP SOCKET (WITH TERMINAL)
001 171 390002 02 00	Üçlü Topraksız Grup Priz (2Mt) Olimpia	3 GANG SOCKET SOCKET OUTLET (2 mt cord)
001 171 390002 03 00	Üçlü Topraksız Grup Priz(3Mt) Olimpia	3 GANG SOCKET SOCKET OUTLET (3 mt cord)
001 171 390002 05 00	Üçlü Topraksız Grup Priz (5Mt) Olimpia	3 GANG SOCKET SOCKET OUTLET (5 mt cord)
001 171 310001 00 00	Üçlü Grup Priz Topraklı (Klemensli) Olimpia	3 GANG EARTHED SOCKET (WITH TERMINAL)
001 171 310002 02 00	Üçlü Topraklı Grup Priz (2Mt) Olimpia	3 GANG EARTHED SOCKET (2 mt)
001 171 310002 03 00	Üçlü Topraklı Grup Priz (3Mt) Olimpia	3 GANG EARTHED SOCKET (3 mt)
001 171 310002 05 00	Üçlü Topraklı Grup Priz (5Mt) Olimpia	3 GANG EARTHED SOCKET (5 mt)
001 171 320002 02 00	Üçlü Topraklı Grup Priz (Klemensli Anahtarlı) Olimpia	3 GANG EARTHED SOCKET (WITH TERMINAL AND SWITCH)
001 171 320001 00 00	Üçlü Topraklı Grup Priz (Anahtarlı 2 Mt) Olimpia	3 GANG EARTHED SOCKET (WITH SWITCH 2 mt)
001 171 320002 03 00	Üçlü Topraklı Grup Priz (Anahtarlı 3 Mt) Olimpia	3 GANG EARTHED SOCKET (WITH SWITCH 3 mt)
001 171 320002 05 00	Üçlü Topraklı Grup Priz (Anahtarlı 5 Mt) Olimpia	3 GANG EARTHED SOCKET (WITH SWITCH 5 mt)
001 171 340001 00 00	Üçlü Ups Grup Priz (Klemensli) Olimpia	EARTHED 3 GANG UPS SOCKET (WITH TERMINAL)
001 171 330001 02 00	Üçlü Ups Grup Priz (2Mt) Olimpia	3 GANG UPS EARTHED (2 mt)
001 171 330001 03 00	Üçlü Ups Grup Priz (3Mt) Olimpia	3 GANG UPS EARTHED (3 mt)
001 171 330001 05 00	Üçlü Ups Grup Priz (5Mt) Olimpia	3 GANG UPS EARTHED (5 mt)
001 171 410001 00 00	Dörtlü Topraklı Grup Priz (Klemensli) Olimpia	4 GANG EARTHED SOCKET (WITH TERMINAL)
001 171 410001 02 00	Dörtlü Topraklı Grup Priz (2Mt) Olimpia	4 GANG EARTHED SOCKET (2 mt)
001 171 410001 03 00	Dörtlü Topraklı Grup Priz (3Mt) Olimpia	4 GANG EARTHED SOCKET (3 mt)
001 171 410001 05 00	Dörtlü Topraklı Grup Priz (5Mt) Olimpia	4 GANG EARTHED SOCKET (5 mt)
001 171 410002 00 00	Dörtlü Topraklı Grup Priz (Klemensli-Anah. Olimpia)	4 GANG EARTHED SOCKET (WITH TERMINAL AND SWITCH)
001 171 410002 02 00	Dörtlü Topraklı Grup Priz (Anahtarlı 2 Mt) Olimpia	4 GANG EARTHED SOCKET(WITH SWITCH 2 mt)
001 171 410002 03 00	Dörtlü Topraklı Grup Priz (Anahtarlı 3 Mt) Olimpia	4 GANG EARTHED SOCKET(WITH SWITCH 3 mt)
001 171 410002 05 00	Dörtlü Topraklı Grup Priz (Anahtarlı 5 Mt) Olimpia	4 GANG EARTHED SOCKET(WITH SWITCH 5 mt)
001 171 610001 00 00	Altılı Grup Priz Top.lı (Klemensli) Olimpia	6 GANG EARTHED SOCKET (WITH TERMINAL)
001 171 610001 02 00	Altılı Topraklı Grup Priz (2 Mt) Olimpia	6 GANG EARTHED SOCKET (2 mt)
001 171 610001 03 00	Altılı Topraklı Grup Priz (3 Mt) Olimpia	6 GANG EARTHED SOCKET (3 mt)
001 171 610001 05 00	Altılı Topraklı Grup Priz (5 Mt) Olimpia	6 GANG EARTHED SOCKET (5 mt)
001 171 610002 00 00	Altılı Topraklı Grup Priz (Klemensli-Anahtarlı) Olimpia	6 GANG EARTHED SOCKET (WITH TERMINAL AND SWITCH)
001 171 610002 02 00	Altılı Topraklı Grup Priz (Anahtarlı 2 Mt) Olimpia	6 GANG EARTHED SOCKET(WITH SWITCH 2 mt)
001 171 610002 03 00	Altılı Topraklı Grup Priz (Anahtarlı 3 Mt) Olimpia	6 GANG EARTHED SOCKET(WITH SWITCH 3 mt)
001 171 610002 05 00	Altılı Topraklı Grup Priz (Anahtarlı 5 Mt) Olimpia	6 GANG EARTHED SOCKET(WITH SWITCH 5 mt)
001 170 110001 00 00	10'lu Topraklı Grup Priz (Klemensli)	10 GANG EARTHED SOCKET (W/OUT CABLE)

# Aksesuarlar

ACCESSORIES



# AKSESUARLAR • ACCESSORIES



Kod / Code	Ürün Tanımı	Descriptions
001 170 012001 00 00	Topraklı Erkek Fiş (Kuyruklu)	Earthed Male Plug (Tailed)
001 170 010001 00 00	Erkek Fiş	Male Socket
001 170 013001 00 00	Topraklı Erkek Fiş Ups (Kuyruklu)	Earthed Male Plug Ups (Tailed)
001 170 020001 00 00	Dişi Fiş	Female Socket
001 170 011001 00 00	Topraklı Erkek Fiş	Earthed Male Plug
001 170 021001 00 00	Topraklı Dişi Fiş	Earthed Female Plug
001 170 014001 00 00	Topraklı Erkek Fiş Ups	Earthed Male Plug Ups
001 170 011002 00 00	Kulplu Topraklı Erkek Fiş	Earthed Male Plug With Handle
001 170 051001 00 00	Topraklı Erkek Fiş	Earthed Male Plug
001 170 061001 00 00	Topraklı Dişi Fiş	Earthed Female Plug
001 170 050001 00 00	Erkek Fiş	Male Socket
001 170 060001 00 00	Dişi Fiş	Female Socket
001 170 033001 00 00	Topraklı Üçlü Fiş-Priz (Yonca Tip) (S/A)	Triple Earthed Socket • Switch (Yonca Type) (Recessed Mounted)
001 170 033002 00 00	Topraklı Üçlü Fiş-Priz (Yonca Tip) (S/Ü)	Triple Earthed Socket • Switch (Yonca Type) (Surface Mounted)
001 170 030002 00 00	Adaptör Fiş, Priz (İngiliz Tip)	Adepter - Socket (British Type)
001 170 030001 00 00	Arapuar Anahtar	Bakalite Hand Switch
001 170 033003 00 00	İkili Topraklı Fiş-Priz (Düz Tip)	Earthed 2 Gang Socket
001 170 033005 00 00	Üçlü Topraklı Fiş-Priz (Düz Tip)	Earthed 3 Gang Socket
001 170 033004 00 00	Üçlü Topraklı Fiş-Priz (Düz Tip Anahtarı)	Earthed 2 Gang Socket With Switch
001 888 000001 00 00	Prizmatik Çocuk Koruma Kapağı	Socketmatic Child Protection Cover

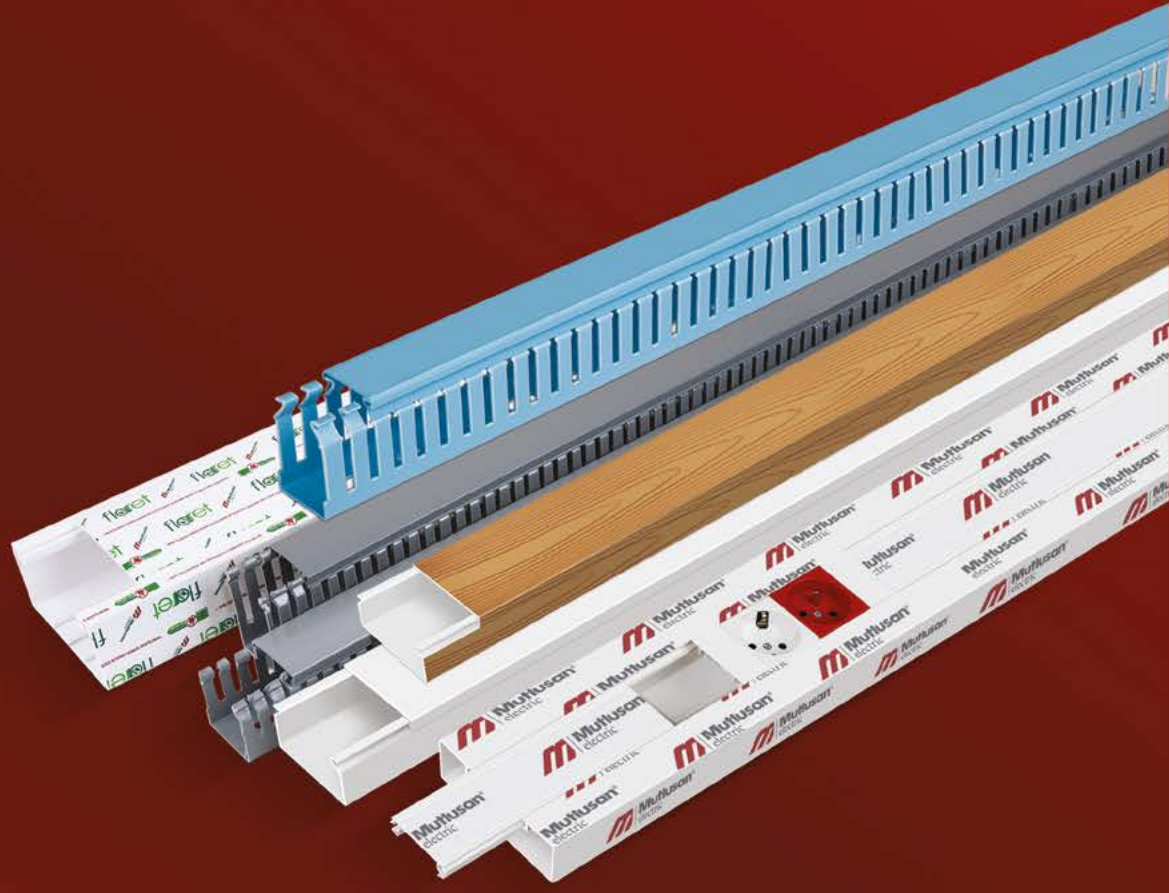

**Kablo Kanalları**

• Cable Trunking

**Renkli Kablo Kanalları**

• Colored Cable Trunking

**Zemin Kablo Kanalları**

• Floor Cable Trunking

**Promex Delikli Kablo Kanalları**

• Slotted Cable Trunking



**KABLO KANALLARI**  
CABLE TRUNKING



## Neden Mutlusan kablo kanallarını kullanmalıyız? Why should we use Mutlusan cable trunking?

- 1** Ürünlerimiz hafif ve dayanıklıdır,  
Our products are light-weighted and durable,
- 2** Ürünlerimizin büyük çoğunluğunun aynı ebatlarda aksesuarları mevcuttur  
Availability of cable trunking accessories with identical sizes for majority of our products,
- 3** İstenilen ölçülerde kesilebilir ve istenen renkte boyanabilir olma özelliği,  
Our products can be tailor-cut to the desired dimensions and can be painted to desired color,
- 4** Zengin renk ve desenleriyle yapılarınızın dekorasyonu ile estetik bir uyum içerisinde oluşu,  
Our products are in aesthetic harmony with the decoration of your buildings by virtue of rich color and pattern options,
- 5** Tadilatlı uygulamalar duvarda sıva hatalarına neden olurken, kablo kanalları uygulaması duvarlarınızın kırılıp dökülerek deforme olmasını önler,  
While modification practices cause plaster errors on your walls, cable trunking applications prevent deformation of your walls due to demolition,
- 6** Kanal içindeki ray sistemiyle kabloların birbirinden bağımsız bir şekilde taşınabilmesi, aynı kanaldan birden fazla kablo geçirilebilir olması özelliği,  
The rail system within the trunking enables installation of cables independently and multiple cables can be laid inside the same trunking,
- 7** Kablo kanallarındaki geçmeli sistemin montaj kolaylığı sağlar,  
Ease of assembly through click-fit system at cable trunking,
- 8** Mükemmel kalıp tasarımı sayesinde üstün yüzey düzgünlüğü,  
Superior surface smoothness by virtue of excellent die design,
- 9** Pano içi delikli kablo kanallarının endüstriyel uygulamalardaki esnek kablo döşemelerinde kullanılabilir  
Perforated cable trunking can be used at flexible cable installations for industrial practices,
- 10** Priz ve anahtar montajında geçmeli montaj özelliği sayesinde pratik ve kolay sabitleme özelliği, kolay montaj,  
Practical and easy fixation and easy assembly by virtue of click-fit assembly feature of power outlets and switches'
- 11** Kanal gövdesindeki delikler sayesinde hızlı montaj olanağı, sabitleme ayakları sayesinde kolay anahtar ve priz montajı yapılabilir  
Quick assembly by virtue of pre-drilled perforations on the trunking body and easy switch and socket assembly by virtue of fixing tool,
- 12** Elektrik kablolarının ve bilgisayar sistemlerinin düzenlenmesinde, asansör ve doğalgaz boru kapatmalarında, prefabrik yapılar ve güvenlik sistemlerinde yaygın kullanım.  
Extensive usage for arrangement of electrical wiring and computer systems, elevator and natural gas piping enclosures and prefabricated structures and security systems

# Teknik özellikler

## Technical specifications



Ultraviyole ışınlarına  
karşı dayanıklıdır.  
Resistance to UV light.



Asit buharına  
dayanıklıdır.  
Resistance to acidic  
vapor.



Darbelere  
dayanıklıdır.  
Shock resistance.



Elektiriksel yalıtım  
özellğine sahiptir.  
Electrically insulated



Tüm kanallarımız çift  
tarafli yapışkanlı bant  
ile kullanılabilir.  
Adhesive models are  
easy to install.



İstenilen renkte  
boyanabilir.  
Can be painted to  
desired color.



Aşırı soğuşa ve sıcağa  
karşı dayanıklı.  
Resistant to extreme  
cold and heat.

### IP4X

Katı yabancı  
maddelerin girişine  
karşı koruma.  
Protection against  
ingress of solid  
foreign substances.

**Halogen Free  
kablo kanalı**  
Halogen free  
cable trunking



**floret**



Flame Retardant  
Alev Yaymayan



**25x16**

Ürün Kodu	Product Code	001 060 025016 20 00
Ambalaj Şekli	Packing Type	Kutu - Box
Adet / m	Quantity / m	150 m
Ağırlık	Weight	17,325 kg
m <sup>3</sup> /	Volume	0.07636

**AKSESUARLAR - ACCESSORIES**

Kod Code	Ürün Product	Adet Quantity	Ağırlık Weight	m <sup>3</sup> Volume
 001 039 025016 11 00	İç Köşe Internal Corner	40	0,390 kg	0,00293
 001 040 025016 11 00	Dış Köşe External Corner	40	0,484 kg	0,00293
 001 041 025016 11 00	T Köşe T Corner	30	0,395 kg	0,00293
 001 042 025016 11 00	90° L Köşe 90° L Corner	80	0,720 kg	0,00364
 001 043 025016 11 00	Ek Parça Connector	100	0,260 kg	0,00139
 001 044 025016 11 00	Uç Tapa Blind Cap	100	0,240 kg	0,00139
 001 047 017421 11 00	PM Kasası 1'li Socket Assembly Frame Single	12	1,290 kg	0,00600

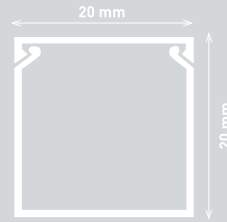
**25x25**

Ürün Kodu	Product Code	001 060 025025 20 00
Ambalaj Şekli	Packing Type	Kutu - Box
Adet / m	Quantity / m	100 m
Ağırlık	Weight	15,500 kg
m <sup>3</sup> /	Volume	0.07636

**AKSESUARLAR - ACCESSORIES**

Kod Code	Ürün Product	Adet Quantity	Ağırlık Weight	m <sup>3</sup> Volume
 001 039 025025 11 00	İç Köşe Internal Corner	40	0,424 kg	0,00293
 001 040 025025 11 00	Dış Köşe External Corner	40	0,516 kg	0,00293
 001 041 025025 11 00	T Köşe T Corner	30	0,405 kg	0,00293
 001 042 025025 11 00	90° L Köşe 90° L Corner	50	0,516 kg	0,00293
 001 043 025025 11 00	Ek Parça Connector	100	0,184 kg	0,00139
 001 044 025025 11 00	Uç Tapa Blind Cap	100	0,310 kg	0,00139
 001 047 017421 11 00	PM Kasası 1'li Socket Assembly Frame Single	12	1,290 kg	0,00600



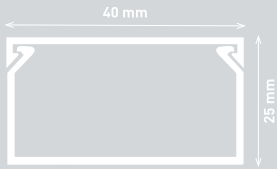

## 40x25



Ürün Kodu	Product Code	001 060 04025 20 00
Ambalaj Şekli	Packing Type	Kutu - Box
Adet / m	Quantity / m	80 m
Ağırlık	Weight	17,200 kg
m <sup>3</sup> /	Volume	0,09272

### AKSESUARLAR - ACCESSORIES

Kod Code	Ürün Product	Adet Quantity	Ağırlık Weight	m <sup>3</sup> Volume
 001 039 040025 11 00	İç Köşe Internal Corner	24	0,449 kg	0,00293
 001 040 040025 11 00	Dış Köşe External Corner	30	0,711 kg	0,00293
 001 041 040025 11 00	T Köşe T Corner	18	0,407 kg	0,00293
 001 042 040025 11 00	90° L Köşe 90° L Corner	24	0,432 kg	0,00293
 001 043 040025 11 00	Ek Parça Connector	70	0,353 kg	0,00293
 001 044 040025 11 00	Uç Tapa Blind Cap	25	0,158 kg	0,00139





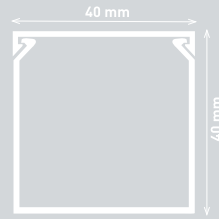



## 40x40



Ürün Kodu	Product Code	001 060 04040 20 00
Ambalaj Şekli	Packing Type	Kutu - Box
Adet / m	Quantity / m	50 m
Ağırlık	Weight	13,900 kg
m <sup>3</sup> /	Volume	0,09272

### AKSESUARLAR - ACCESSORIES

Kod Code	Ürün Product	Adet Quantity	Ağırlık Weight	m <sup>3</sup> Volume
 001 039 040040 11 00	İç Köşe Internal Corner	18	0,504 kg	0,00282
 001 040 040040 11 00	Dış Köşe External Corner	10	0,320 kg	0,00282
 001 041 040040 11 00	T Köşe T Corner	48	1,415 kg	0,01011
 001 042 040040 11 00	90° L Köşe 90° L Corner	60	1,488 kg	0,01011
 001 043 040040 11 00	Ek Parça Connector	100	0,722 kg	0,01011
 001 044 040040 11 00	Uç Tapa Blind Cap	25	0,210 kg	0,00139



40x60

**Aksesuarsız**  
Without Accessories



Ürün Kodu	Product Code	001 060 040060 20 00
Ambalaj Şekli	Packing Type	Kutu - Box
Adet / m	Quantity / m	30 m
Ağırlık	Weight	15,138 kg
m <sup>3</sup> /	Volume	0,11029





100x50



Ürün Kodu	Product Code	001 060 100050 20 00
Ambalaj Şekli	Packing Type	Kutu - Box
Adet / m	Quantity / m	20 m
Ağırlık	Weight	16,600 kg
m <sup>3</sup> /	Volume	0,11554



AKSESUARLAR - ACCESSORIES					
Kod Code	Ürün Product	Adet Quantity	Ağırlık Weight	m <sup>3</sup> Volume	
 001 061 100050 20 00	Ara Bölme Partition	150 m	74,250 kg	0,37455	
 001 039 100050 11 00	İç Köşe Hareketli Internal Corner Live	10	0,800 kg	0,00937	
 001 040 100050 11 00	Dış Köşe Hareketli External Corner Live	8	0,896 kg	0,00937	
 001 041 100050 11 00	T Köşe T Corner	10	1,000 kg	0,01312	
 001 042 100050 11 00	90° L Köşe 90° L Corner	10	1,000 kg	0,01312	
 001 043 100050 11 00	Ek Parça Connector	100	1,650 kg	0,01000	
 001 44 100050 11 00	Uç Tapa Blind Cap	40	0,735 kg	0,00400	

## Kendinden kapaklı kanallar

Cable trunking with  
internal cover

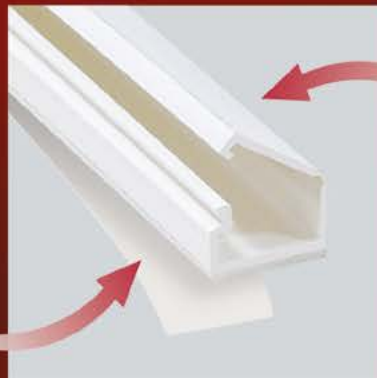

Kendinden Yapışkanlı  
Self-Adhesive

Kendinden Kapaklı  
Intrinsic Cover

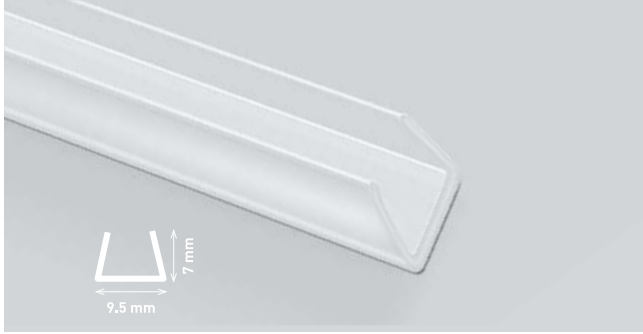
**9.5x7**

**Şeffaf Mini Kanal**  
(Kapaksız - Yapışkanlı)  
Transparent Mini Trunking  
(Without Cover - With Adhesive)

Ürün Kodu	Product Code	001 015 010007 20 00
Ambalaj Şekli	Packing Type	Kutu - Box
Adet / m	Quantity / m	500 m
Ağırlık	Weight	16,450 kg
m <sup>3</sup> /	Volume	0,04000

**9x5**

**Aksesuarsız**  
Without Accessories

Ürün Kodu	Product Code	001 004 009005 20 00
Ambalaj Şekli	Packing Type	Kutu - Box
Adet / m	Quantity / m	500 m
Ağırlık	Weight	18,400 kg
m <sup>3</sup> /	Volume	0,04000

**10x10**

**Aksesuarsız**  
Without Accessories

Ürün Kodu	Product Code	001 004 010010 20 00
Ambalaj Şekli	Packing Type	Kutu - Box
Adet / m	Quantity / m	320 m
Ağırlık	Weight	18,176 kg
m <sup>3</sup> /	Volume	0,04000

**12x7.5**

**Aksesuarsız**  
Without Accessories

Ürün Kodu	Product Code	001 004 012007 20 00
Ambalaj Şekli	Packing Type	Kutu - Box
Adet / m	Quantity / m	350 m
Ağırlık	Weight	18,340 kg
m <sup>3</sup> /	Volume	0,05090

**13x12.5**

**Aksesuarsız**  
Without Accessories

Ürün Kodu	Product Code	001 004 013012 20 00
Ambalaj Şekli	Packing Type	Kutu - Box
Adet / m	Quantity / m	300 m
Ağırlık	Weight	24,090 kg
m <sup>3</sup> /	Volume	0,07636

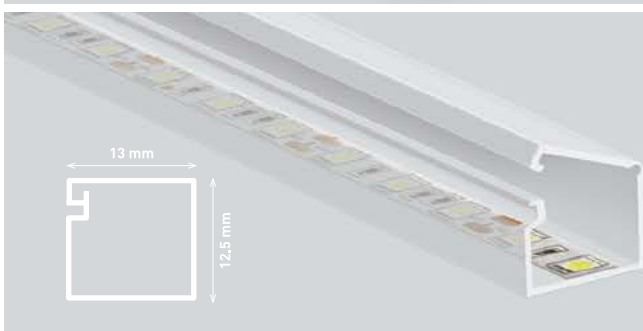
LED  
için özel**13x12.5**

**Şeffaf Kanal**  
Transparent Cable Trunking

Ürün Kodu	Product Code	001 004 013012 20 44
Ambalaj Şekli	Packing Type	Kutu - Box
Adet / m	Quantity / m	300 m
Ağırlık	Weight	18,210 kg
m <sup>3</sup> /	Volume	0,07636

**Dıştan kapaklı  
kanallar**  
Cable trunking with  
external cover

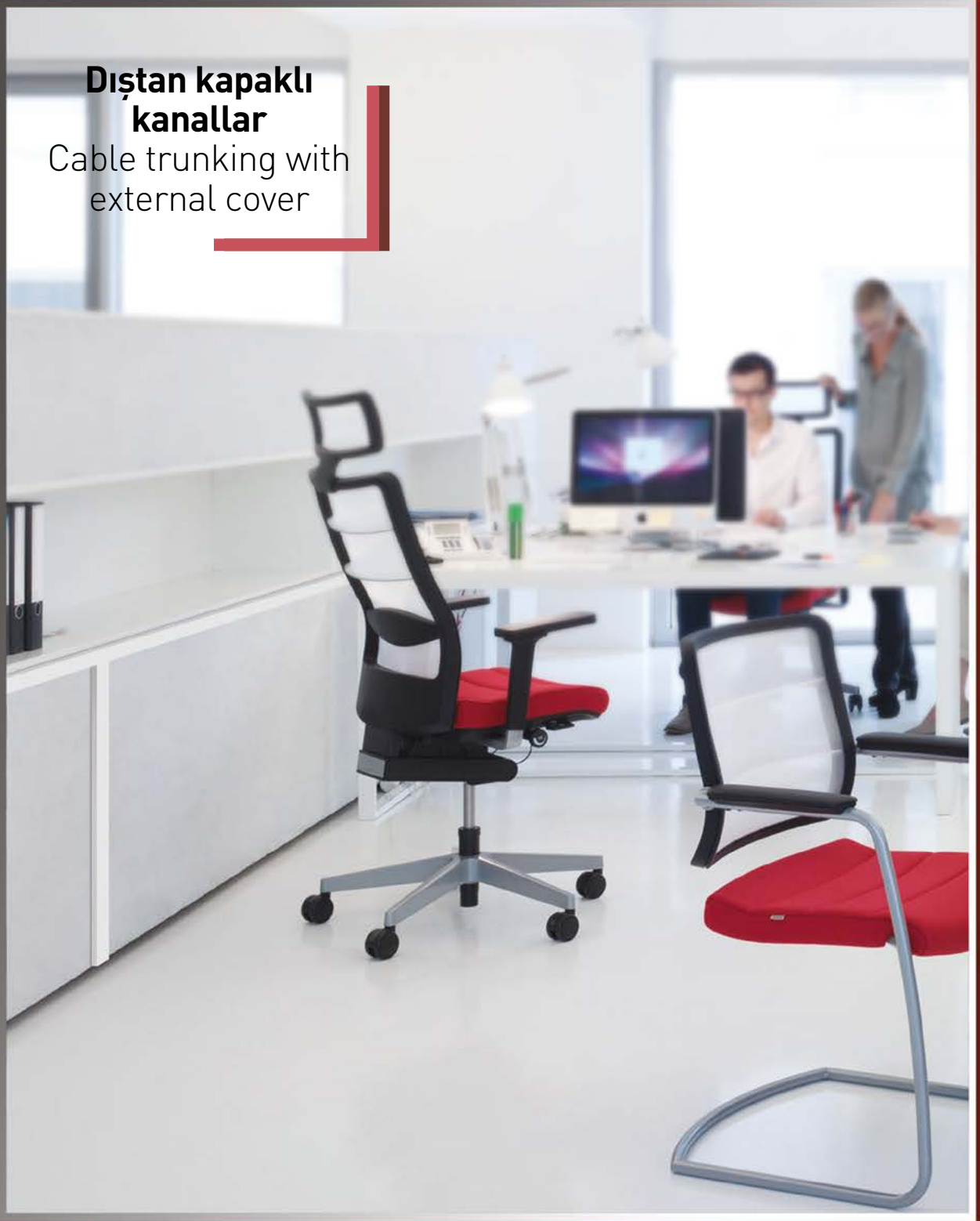

**Dıştan Kapaklı**  
External Cover

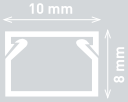
**10x8****Aksesuarsız**  
Without Accessories

		<b>EKO</b> Serişi Series	<b>MEKS</b> Serişi Series
Ürün Kodu	Product Code	001 014 010008 20 00	001 002 010008 20 00
Ambalaj Şekli	Packing Type	Kutu - Box	Kutu - Box
Adet / m	Quantity / m	330 m	330 m
Ağırlık	Weight	17,500	17,500
m <sup>3</sup> /	Volume	0,04000	0,04000

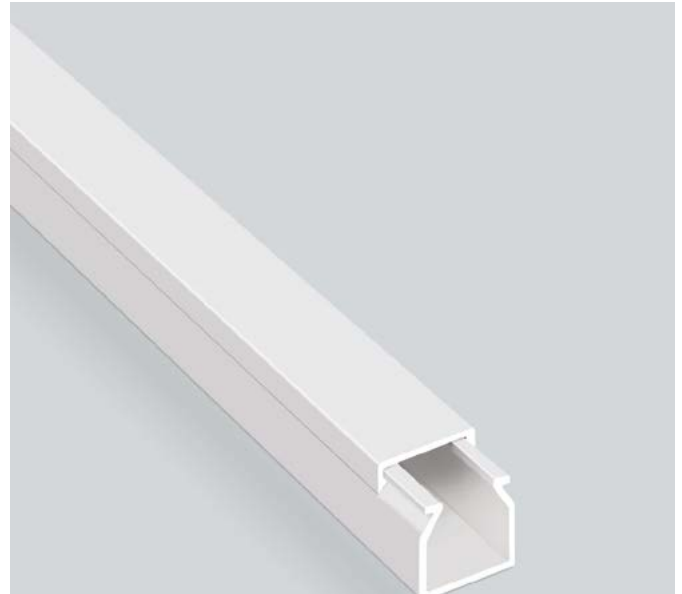
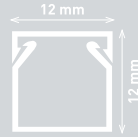
**12x12**

		<b>EKO</b> Serişi Series	<b>MEKS</b> Serişi Series	<b>CANALEX</b> Serişi Series
Ürün Kodu	Product Code	001 014 012012 20 00	001 002 012012 20 00	001 156 012012 20 00
Ambalaj Şekli	Packing Type	Kutu - Box	Kutu - Box	Kutu - Box
Adet / m	Quantity / m	250 m	250 m	250 m
Ağırlık	Weight	17,050 kg	17,050 kg	14,800 kg
m <sup>3</sup> /	Volume	0,05090	0,05090	0,05090

**AKSESUARLAR - ACCESSORIES**

	Kod Code	Ürün Product	Adet Quantity	Ağırlık Weight	m <sup>3</sup> Volume
	001 039 012012 00 00	İç Köşe Internal Corner	60	0,175 kg	0,00139
	001 040 012012 00 00	Dış Köşe External Corner	60	0,215 kg	0,00139
	001 041 012012 00 00	T Köşe T Corner	60	0,195 kg	0,00139
	001 042 012012 00 00	90° L Köşe 90° L Corner	60	0,225 kg	0,00139
	001 043 012012 00 00	Ek Parça Connector	100	0,165 kg	0,00139
	001 044 012012 00 00	Uç Tapa Blind Cap	100	0,145 kg	0,00139

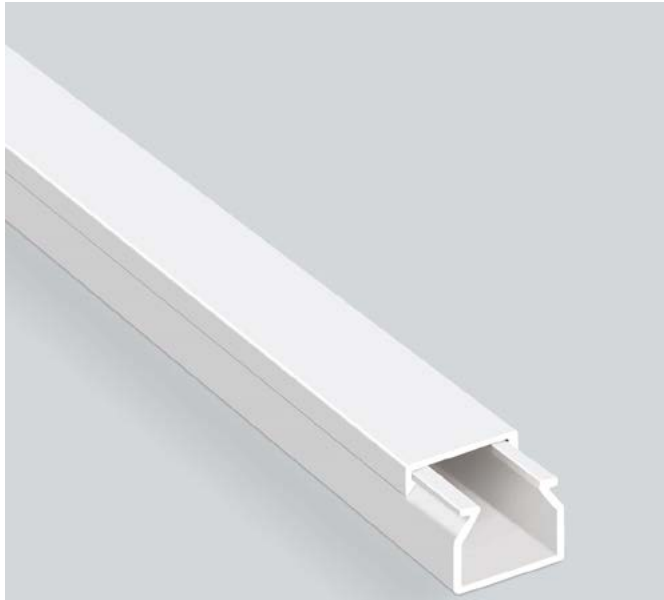

**15x10**

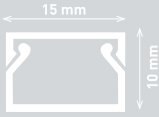

		<b>EKO</b> Seri Series	<b>MEKS</b> Seri Series	<b>CANALEX</b> Seri Series
Ürün Kodu	Product Code	001 014 015010 20 00	001 002 015010 20 00	001 156 015010 20 00
Ambalaj Şekli	Packing Type	Kutu - Box	Kutu - Box	Kutu - Box
Adet / m	Quantity / m	250 m	250 m	250 m
Ağırlık	Weight	19,800 kg	19,800 kg	14,800 kg
m <sup>3</sup> /	Volume	0,05090	0,05090	0,05090

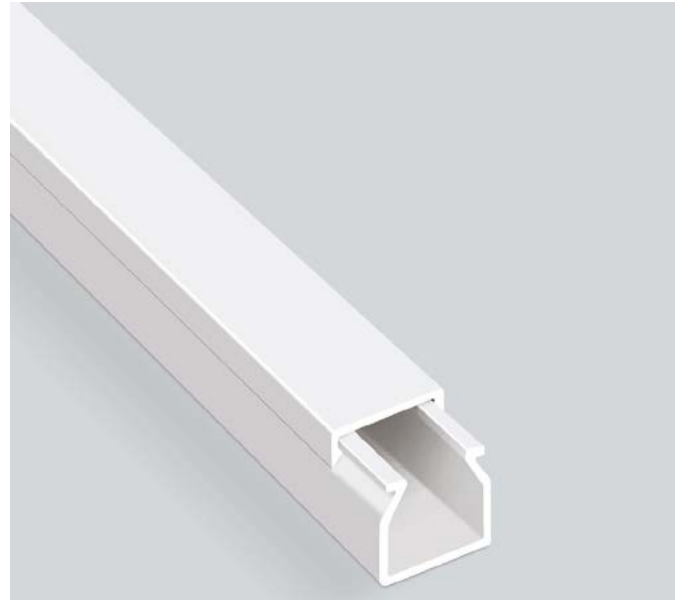





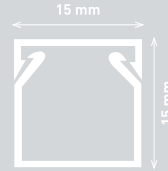

**15x15**

**Aksesuarsız**  
Without Accessories



		<b>EKO</b> Seri Series	<b>MEKS</b> Seri Series
Ürün Kodu	Product Code	001 014 015015 20 00	001 002 015015 20 00
Ambalaj Şekli	Packing Type	Kutu - Box	Kutu - Box
Adet / m	Quantity / m	250 m	250 m
Ağırlık	Weight	23 kg	23 kg
m <sup>3</sup> /	Volume	0,07636	0,07636

**AKSESUARLAR - ACCESSORIES**

	Kod Code	Ürün Product	Adet Quantity	Ağırlık Weight	m <sup>3</sup> Volume
	001 039 015010 00 00	İç Köşe Internal Corner	60	0,195 kg	0,00139
	001 040 015010 00 00	Dış Köşe External Corner	60	0,220 kg	0,00139
	001 041 015010 00 00	T Köşe T Corner	60	0,240 kg	0,00139
	001 042 015010 00 00	90° L Köşe 90° L Corner	60	0,190 kg	0,00139
	001 043 015010 00 00	Ek Parça Connector	100	0,250 kg	0,00139
	001 044 015010 00 00	Uç Tapa Blind Cap	100	0,150 kg	0,00139





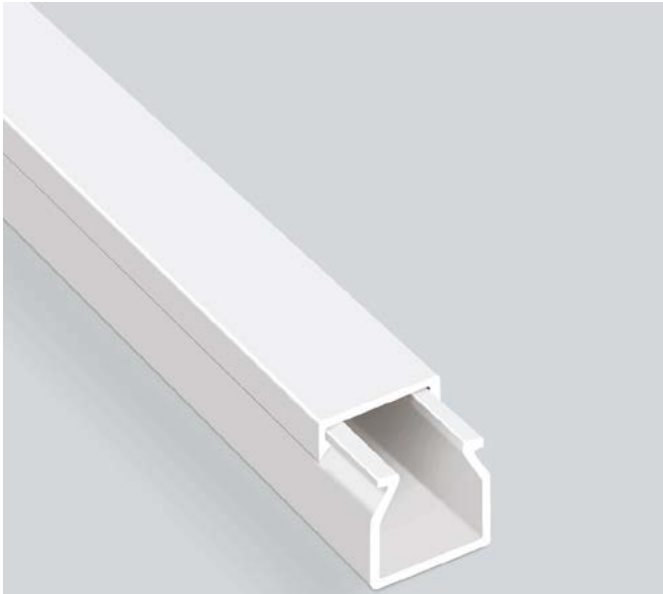



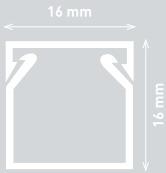

# 16x16



		<b>EKO</b> Seri Series	<b>MEKS</b> Seri Series	<b>CANALEX</b> Seri Series
Ürün Kodu	Product Code	001 014 016016 20 00	001 002 016016 20 00	001 156 016016 20 00
Ambalaj Şekli	Packing Type	Kutu - Box	Kutu - Box	Kutu - Box
Adet / m	Quantity / m	250 m	250 m	250 m
Ağırlık	Weight	26,900 kg	27,390 kg	20,650 kg
m <sup>3</sup> /	Volume	0,07636	0,07636	0,07636

### AKSESUARLAR - ACCESSORIES

	Kod Code	Ürün Product	Adet Quantity	Ağırlık Weight	m <sup>3</sup> Volume
	001 039 016016 00 00	İç Köşe Internal Corner	60	0,240 kg	0,00293
	001 040 016016 00 00	Dış Köşe External Corner	60	0,265 kg	0,00293
	001 041 016016 00 00	T Köşe T Corner	60	0,400 kg	0,00293
	001 042 016016 00 00	90° L Köşe 90° L Corner	60	0,330 kg	0,00293
	001 043 016016 00 00	Ek Parça Connector	100	0,250 kg	0,00139
	001 044 016016 00 00	Uç Tapa Blind Cap	100	0,190 kg	0,00139



# 20x10

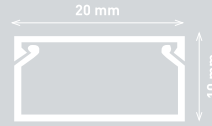

		<b>EKO</b> Seri Series	<b>MEKS</b> Seri Series	<b>CANALEX</b> Seri Series
Ürün Kodu	Product Code	001 014 020010 20 00	001 002 020010 20 00	001 156 020010 20 00
Ambalaj Şekli	Packing Type	Kutu - Box	Kutu - Box	Kutu - Box
Adet / m	Quantity / m	200 m	200 m	200 m
Ağırlık	Weight	17,050 kg	17,050 kg	15,060 kg
m <sup>3</sup> /	Volume	0,05090	0,05090	0,05090

### AKSESUARLAR - ACCESSORIES

	Kod Code	Ürün Product	Adet Quantity	Ağırlık Weight	m <sup>3</sup> Volume
	001 039 020010 00 00	İç Köşe Internal Corner	60	0,200 kg	0,00139
	001 040 020010 00 00	Dış Köşe External Corner	60	0,245 kg	0,00139
	001 041 020010 00 00	T Köşe T Corner	30	0,170 kg	0,00139
	001 042 020010 00 00	90° L Köşe 90° L Corner	50	0,240 kg	0,00293
	001 043 020010 00 00	Ek Parça Connector	100	0,210 kg	0,00139
	001 044 020010 00 00	Uç Tapa Blind Cap	100	0,200 kg	0,00139



**20x15**



		<b>EKO</b> Serisi Series	<b>MEKS</b> Serisi Series
Ürün Kodu	Product Code	001 014 020015 20 00	001 002 020015 20 00
Ambalaj Şekli	Packing Type	Kutu - Box	Kutu - Box
Adet / m	Quantity / m	144 m	144 m
Ağırlık	Weight	15,120 kg	15,120 kg
m <sup>3</sup> /	Volume	0,07636	0,07636



**20x20** | **Aksesuarsız**  
Without Accessories



		<b>EKO</b> Serisi Series	<b>MEKS</b> Serisi Series
Ürün Kodu	Product Code	001 014 020020 20 00	001 002 020020 20 00
Ambalaj Şekli	Packing Type	Kutu - Box	Kutu - Box
Adet / m	Quantity / m	156 m	156 m
Ağırlık	Weight	19,695 kg	19,695 kg
m <sup>3</sup> /	Volume	0,07636	0,07636

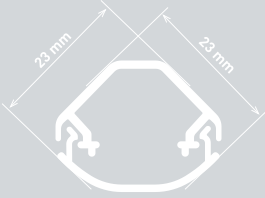

**23x23****Tavan Köşe Kanalı**  
Ceiling Corner Trunking**MEKS** Serisi Series

Ürün Kodu	Product Code	001 002 023023 20 00
Ambalaj Şekli	Packing Type	Kutu - Box
Adet / m	Quantity / m	120 m
Ağırlık	Weight	23,940 kg
m <sup>3</sup> /	Volume	0,07636

**AKSESUARLAR - ACCESSORIES**

Kod Code	Ürün Product	Adet Quantity	Ağırlık Weight	m <sup>3</sup> Volume
 001 041 023023 00 00	T Köşe T Corner	60	0,258 kg	0,00293
 001 042 023023 00 00	90° L Köşe 90° L Corner	60	0,252 kg	0,00293
 001 043 023023 00 00	Ek Parça Connector	100	0,150 kg	0,00131
 001 044 023023 00 00	Uç Tapa Blind Cap	100	0,180 kg	0,00139

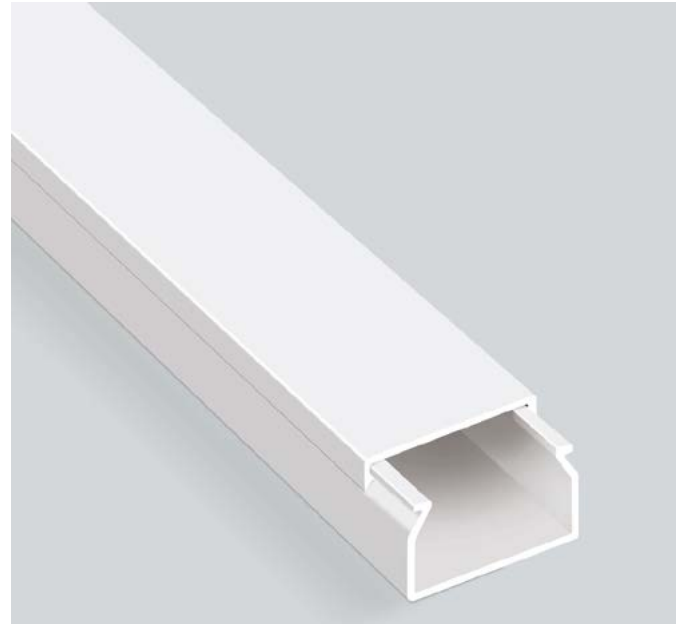
**25x16****EKO** Serisi Series **MEKS** Serisi Series **ÇANALEX** Serisi Series

Ürün Kodu	Product Code	001 014 025016 20 00	001 002 025016 20 00	001 156 025016 20 00
Ambalaj Şekli	Packing Type	Kutu - Box	Kutu - Box	Kutu - Box
Adet / m	Quantity / m	150 m	150 m	150 m
Ağırlık	Weight	20,505 kg	20,660 kg	18,110 kg
m <sup>3</sup> /	Volume	0,07636	0,07636	0,07636

**AKSESUARLAR - ACCESSORIES**

Kod Code	Ürün Product	Adet Quantity	Ağırlık Weight	m <sup>3</sup> Volume
 001 039 025016 00 00	İç Köşe Internal Corner	40	0,390 kg	0,00293
 001 040 025016 00 00	Dış Köşe External Corner	40	0,484 kg	0,00293
 001 041 025016 00 00	T Köşe T Corner	30	0,720 kg	0,00364
 001 042 025016 00 00	90° L Köşe 90° L Corner	80	0,490 kg	0,00293
 001 043 025016 00 00	Ek Parça Connector	100	0,260 kg	0,00139
 001 044 025016 00 00	Uç Tapa Blind Cap	100	0,240 kg	0,00139
 001 047 017421 00 00	PM Kasası 1 li Socket Assembly Frame Single	12	1,290 kg	0,00600

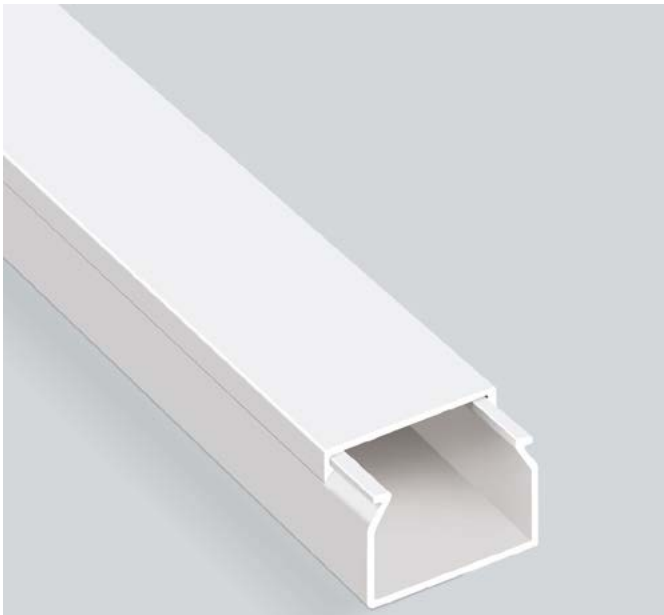

25x25

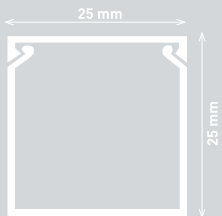

**EKO** Serisi Series  
**MEKS** Serisi Series  
**CANALEX** Serisi Series

Ürün Kodu	Product Code	001 014 025025 20 00	001 002 025025 20 00	001 156 025025 20 00
Ambalaj Şekli	Packing Type	Kutu - Box	Kutu - Box	Kutu - Box
Adet / m	Quantity / m	100 m	100 m	100 m
Ağırlık	Weight	18,760 kg	18,760 kg	17,360 kg
m <sup>3</sup> /	Volume	0,07636	0,07636	0,07636

#### AKSESUARLAR - ACCESSORIES

Kod Code	Ürün Product	Adet Quantity	Ağırlık Weight	m <sup>3</sup> Volume
001 039 025025 00 00	İç Köşe Internal Corner	40	0,424 kg	0,00293
001 040 025025 00 00	Dış Köşe External Corner	40	0,516 kg	0,00293
001 041 025025 00 00	T Köşe T Corner	24	0,405 kg	0,00293
001 042 025025 00 00	90° L Köşe 90° L Corner	40	0,516 kg	0,00293
001 043 025025 00 00	Ek Parça Connector	50	0,184 kg	0,00139
001 044 025025 00 00	Uç Tapa Blind Cap	100	0,310 kg	0,00139
001 047 017421 00 00	PM Kasası 1'li Socket Assembly Frame Single	12	1,290 kg	0,00600

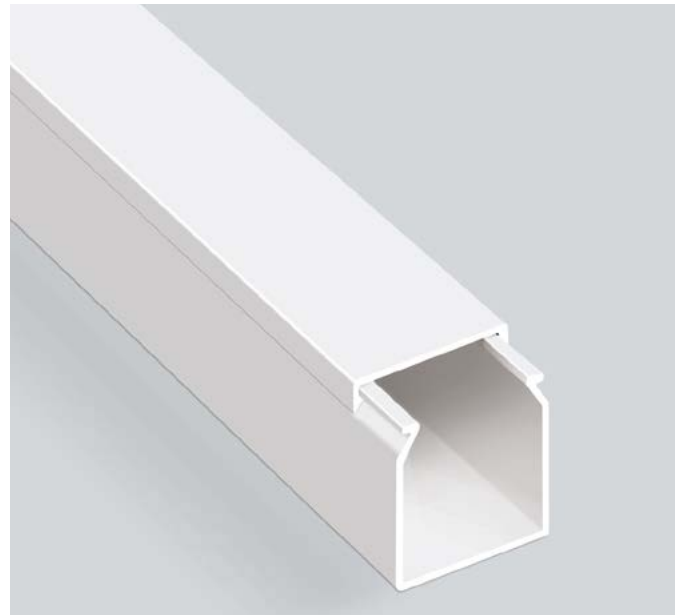

25x40

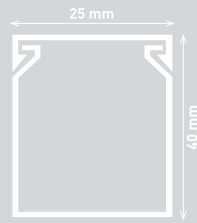

**Aksesuarsız**  
Without Accessories

**EKO** Serisi Series  
**MEKS** Serisi Series

Ürün Kodu	Product Code	001 014 025040 20 00	001 002 025040 20 00
Ambalaj Şekli	Packing Type	Kutu - Box	Kutu - Box
Adet / m	Quantity / m	80 m	80 m
Ağırlık	Weight	24,843 kg	24,840 kg
m <sup>3</sup> /	Volume	0,07636	0,07636



**30x10****Bölmeli**  
Partitioned

		<b>EKO</b> <small>Serisi Series</small>	<b>MEKS</b> <small>Serisi Series</small>
Ürün Kodu	Product Code	001 014 930010 20 00	001 002 930010 20 00
Ambalaj Şekli	Packing Type	Kutu - Box	Kutu - Box
Adet / m	Quantity / m	140 m	140 m
Ağırlık	Weight	18,410 kg	18,410 kg
m <sup>3</sup> /	Volume	0,05090	0,05090

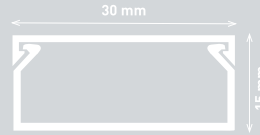
**30x15****Aksesuarsız**  
Without Accessories

		<b>EKO</b> <small>Serisi Series</small>	<b>MEKS</b> <small>Serisi Series</small>
Ürün Kodu	Product Code	001 014 030015 20 00	001 002 030015 20 00
Ambalaj Şekli	Packing Type	Kutu - Box	Kutu - Box
Adet / m	Quantity / m	140 m	140 m
Ağırlık	Weight	21,000 kg	21,000 kg
m <sup>3</sup> /	Volume	0,07636	0,07636

**AKSESUARLAR - ACCESSORIES**

	Kod Code	Ürün Product	Adet Quantity	Ağırlık Weight	m <sup>3</sup> Volume
	001 039 030010 00 00	İç Köşe Internal Corner	50	0,425 kg	0,00293
	001 040 030010 00 00	Dış Köşe External Corner	50	0,490 kg	0,00293
	001 041 030010 00 00	T Köşe T Corner	50	0,595 kg	0,00293
	001 042 030010 00 00	90° L Köşe 90° L Corner	50	0,441 kg	0,00295
	001 043 030025 00 00	Ek Parça Connector	100	0,340 kg	0,00293
	001 044 030025 00 00	Uç Tapa Blind Cap	100	0,405 kg	0,00140





**30x16**

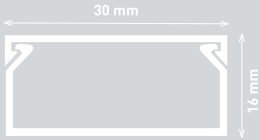

		<b>EKO</b> Serisi Series	<b>MEKS</b> Serisi Series	<b>CANALEX</b> Serisi Series
Ürün Kodu	Product Code	001 014 030016 20 00	001 002 030016 20 00	001 156 030016 20 00
Ambalaj Şekli	Packing Type	Kutu - Box	Kutu - Box	Kutu - Box
Adet / m	Quantity / m	140 m	140 m	140 m
Ağırlık	Weight	23,282 kg	22,862 kg	20,720 kg
m <sup>3</sup> /	Volume	0,07636	0,07636	0,07636

**AKSESUARLAR - ACCESSORIES**

Kod Code	Ürün Product	Adet Quantity	Ağırlık Weight	m <sup>3</sup> Volume
001 039 030016 00 00	İç Köşe Internal Corner	35	0,380 kg	0,00293
001 040 030016 00 00	Dış Köşe External Corner	48	0,605 kg	0,00293
001 041 030016 00 00	T Köşe T Corner	40	0,565 kg	0,00293
001 042 030016 00 00	90° L Köşe 90° L Corner	50	0,535 kg	0,00293
001 043 030025 00 00	Ek Parça Connector	100	0,340 kg	0,00293
001 044 030025 00 00	Uç Tapa Blind Cap	100	0,405 kg	0,00140
001 047 017421 00 00	PM Kasası 1'li Socket Assembly Frame Single	12	1,290 kg	0,00600

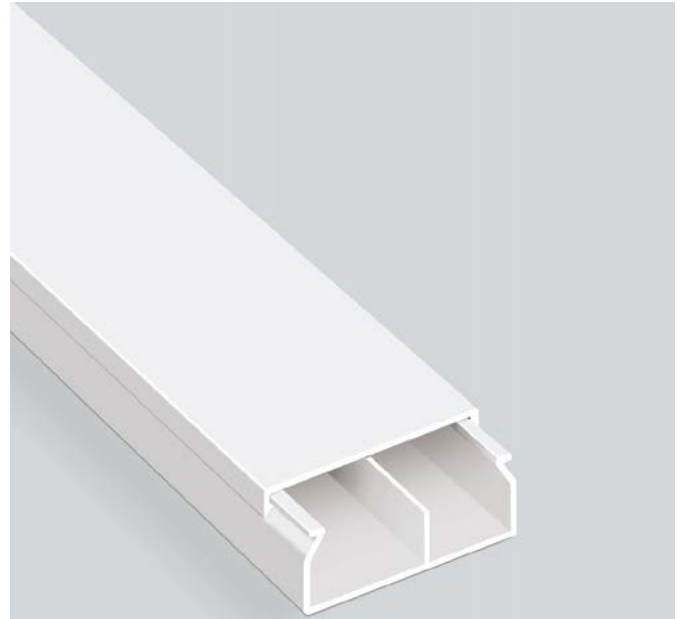

**30x16**

**Bölmeli**  
Partitioned

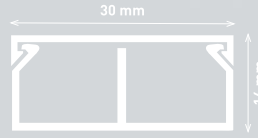

		<b>EKO</b> Serisi Series	<b>MEKS</b> Serisi Series
Ürün Kodu	Product Code	001 014 930016 20 00	001 002 930016 20 00
Ambalaj Şekli	Packing Type	Kutu - Box	Kutu - Box
Adet / m	Quantity / m	140 m	140 m
Ağırlık	Weight	22,860 kg	22,860 kg
m <sup>3</sup> /	Volume	0,07636	0,07636

**AKSESUARLAR - ACCESSORIES**

Kod Code	Ürün Product	Adet Quantity	Ağırlık Weight	m <sup>3</sup> Volume
001 039 030016 00 00	İç Köşe Internal Corner	35	0,380 kg	0,00293
001 040 030016 00 00	Dış Köşe External Corner	48	0,605 kg	0,00293
001 041 030016 00 00	T Köşe T Corner	40	0,565 kg	0,00293
001 042 030016 00 00	90° L Köşe 90° L Corner	50	0,535 kg	0,00293
001 043 030025 00 00	Ek Parça Connector	100	0,340 kg	0,00293
001 044 030025 00 00	Uç Tapa Blind Cap	100	0,405 kg	0,00140
001 047 017421 00 00	PM Kasası 1'li Socket Assembly Frame Single	12	1,290 kg	0,00600



## 30x25

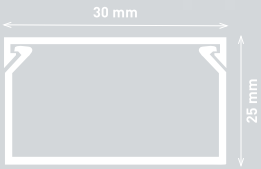

		<b>EKO</b> Serisi Series	<b>MEKS</b> Serisi Series
Ürün Kodu	Product Code	001 014 030025 20 00	001 002 030025 20 00
Ambalaj Şekli	Packing Type	Kutu - Box	Kutu - Box
Adet / m	Quantity / m	80 m	80 m
Ağırlık	Weight	15,860 kg	15,860 kg
m <sup>3</sup> /	Volume	0,07636	0,07636

### AKSESUARLAR - ACCESSORIES

	Kod Code	Ürün Product	Adet Quantity	Ağırlık Weight	m <sup>3</sup> Volume
	001 039 030025 00 00	İç Köşe Internal Corner	32	0,470 kg	0,00293
	001 040 030025 00 00	Dış Köşe External Corner	30	0,530 kg	0,00293
	001 041 030025 00 00	T Köşe T Corner	24	0,445 kg	0,00293
	001 042 030025 00 00	90° L Köşe 90° L Corner	30	0,430 kg	0,00293
	001 043 030025 00 00	Ek Parça Connector	100	0,340 kg	0,00293
	001 044 030025 00 00	Uç Tapa Blind Cap	100	0,405 kg	0,00140
	001 047 017421 00 00	PM Kasası 1'li Socket Assembly Frame Single	12	1,290 kg	0,00600

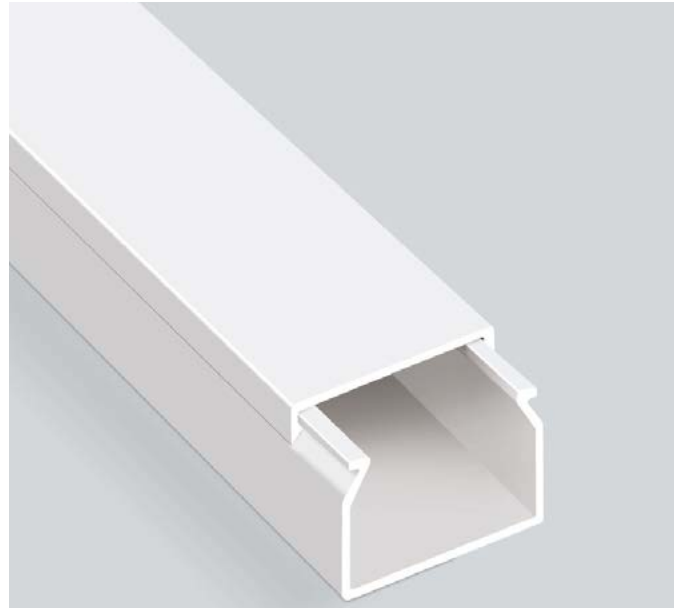

## 30x30

**Aksesuarsız**  
Without Accessories

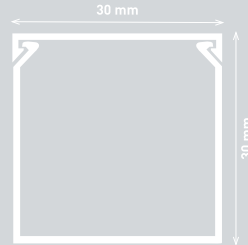

		<b>EKO</b> Serisi Series	<b>MEKS</b> Serisi Series
Ürün Kodu	Product Code	001 014 030030 20 00	001 002 030030 20 00
Ambalaj Şekli	Packing Type	Kutu - Box	Kutu - Box
Adet / m	Quantity / m	80 m	80 m
Ağırlık	Weight	16,480 kg	16,480 kg
m <sup>3</sup> /	Volume	0,09272	0,09272





40x16

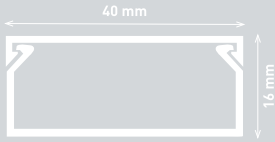

		EKO Seri Series	MEKS Seri Series	CANALEX Seri Series
Ürün Kodu	Product Code	001 014 040016 20 00	001 002 040016 20 00	001 156 040016 20 00
Ambalaj Şekli	Packing Type	Kutu - Box	Kutu - Box	Kutu - Box
Adet / m	Quantity / m	100 m	100 m	100 m
Ağırlık	Weight	18,900 kg	18,900 kg	17,660 kg
m <sup>3</sup> /	Volume	0,07636	0,07636	0,07636

#### AKSESUARLAR - ACCESSORIES

	Kod Code	Ürün Product	Adet Quantity	Ağırlık Weight	m <sup>3</sup> Volume
	001 039 040016 00 00	İç Köşe Internal Corner	32	0,432 kg	0,00293
	001 040 040016 00 00	Dış Köşe External Corner	30	0,519 kg	0,00293
	001 041 040016 00 00	T Köşe T Corner	24	0,461 kg	0,00293
	001 042 040016 00 00	90° L Köşe 90° L Corner	34	0,524 kg	0,00293
	001 043 040040 00 00	Ek Parça Connector	100	0,753 kg	0,00937
	001 044 040040 00 00	Uç Tapa Blind Cap	50	0,200 kg	0,00182
	001 047 017421 00 00	PM Kasası 1'li Socket Assembly Frame Single	12	1,290 kg	0,00600



40x16

Bölmeli  
Partitioned

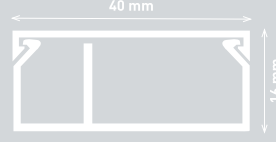

		EKO Seri Series	MEKS Seri Series
Ürün Kodu	Product Code	001 014 940016 20 00	001 002 940016 20 00
Ambalaj Şekli	Packing Type	Kutu - Box	Kutu - Box
Adet / m	Quantity / m	100 m	100 m
Ağırlık	Weight	23,160 kg	23,160 kg
m <sup>3</sup> /	Volume	0,07636	0,07636

#### AKSESUARLAR - ACCESSORIES

	Kod Code	Ürün Product	Adet Quantity	Ağırlık Weight	m <sup>3</sup> Volume
	001 039 040016 00 00	İç Köşe Internal Corner	32	0,432 kg	0,00293
	001 040 040016 00 00	Dış Köşe External Corner	30	0,519 kg	0,00293
	001 041 040016 00 00	T Köşe T Corner	24	0,461 kg	0,00293
	001 042 040016 00 00	90° L Köşe 90° L Corner	34	0,524 kg	0,00293
	001 043 040040 00 00	Ek Parça Connector	100	0,753 kg	0,00937
	001 044 040040 00 00	Uç Tapa Blind Cap	25	0,210 kg	0,00139
	001 047 017421 00 00	PM Kasası 1'li Socket Assembly Frame Single	12	1,290 kg	0,00600

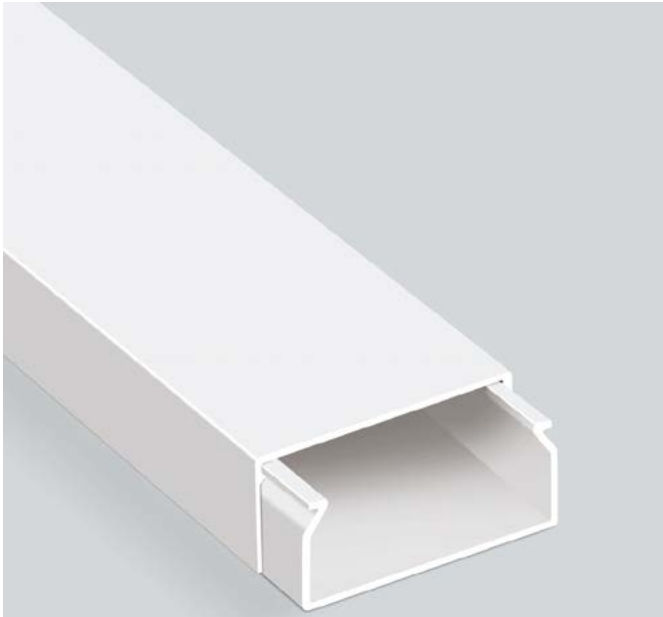
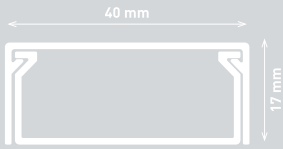

**40x17****Tam Kapaklı - Full Cover**  
**Aksesuarsız - Without Accessories****MEKS** Serisi  
Series

Ürün Kodu	Product Code	001 002 040017 20 00
Ambalaj Şekli	Packing Type	Kutu - Box
Adet / m	Quantity / m	100 m
Ağırlık	Weight	26,160 kg
m <sup>3</sup> /	Volume	0,07636

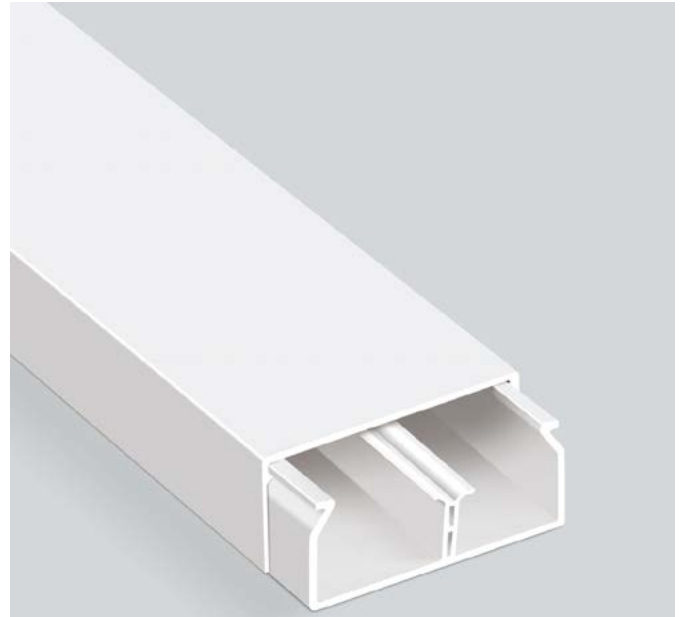
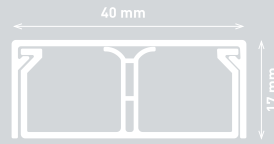
**40x17****Tam Kapaklı Bölmeli**  
**Full Cover and Partitioned**  
**Aksesuarsız**  
**Without Accessories****MEKS** Serisi  
Series

Ürün Kodu	Product Code	001 002 940017 20 00
Ambalaj Şekli	Packing Type	Kutu - Box
Adet / m	Quantity / m	100 m
Ağırlık	Weight	28,300 kg
m <sup>3</sup> /	Volume	0,07636



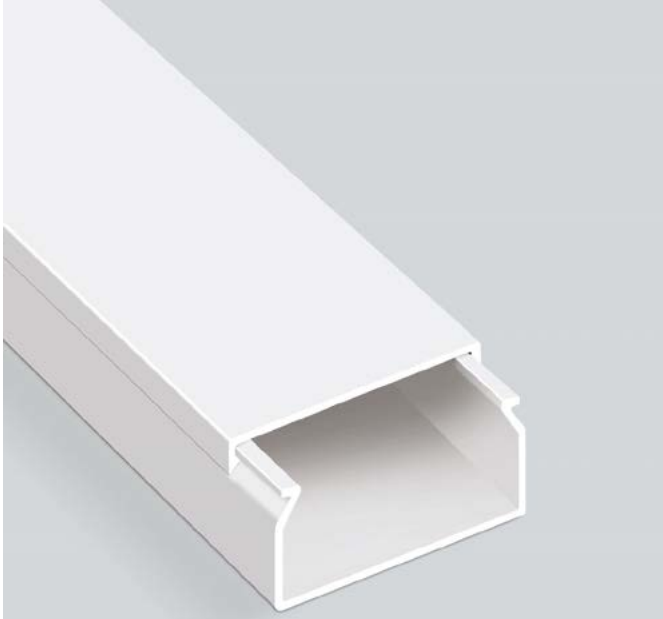

**40x25**

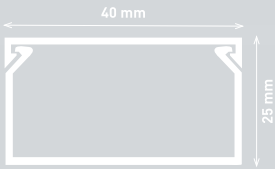

		<b>EKO</b> Seri Series	<b>MEKS</b> Seri Series	<b>CANALEX</b> Seri Series
Ürün Kodu	Product Code	001 014 040025 20 00	001 002 040025 20 00	001 156 040025 20 00
Ambalaj Şekli	Packing Type	Kutu - Box	Kutu - Box	Kutu - Box
Adet / m	Quantity / m	80 m	80 m	80 m
Ağırlık	Weight	19,640 kg	18,840 kg	17,200 kg
m <sup>3</sup> /	Volume	0,09272	0,09272	0,09272

**AKSESUARLAR - ACCESSORIES**

	Kod Code	Ürün Product	Adet Quantity	Ağırlık Weight	m <sup>3</sup> Volume
	001 039 040025 00 00	İç Köşe Internal Corner	24	0,449 kg	0,00293
	001 040 040025 00 00	Dış Köşe External Corner	30	0,711 kg	0,00293
	001 041 040025 00 00	T Köşe T Corner	18	0,407 kg	0,00293
	001 042 040025 00 00	90° L Köşe 90° L Corner	24	0,432 kg	0,00293
	001 043 040040 00 00	Ek Parça Connector	100	0,722 kg	0,01011
	001 044 040040 00 00	Uç Tapa Blind Cap	50	0,350 kg	0,00182
	001 047 017421 00 00	PM Kasası 1'li Socket Assembly Frame Single	12	1,290 kg	0,00600

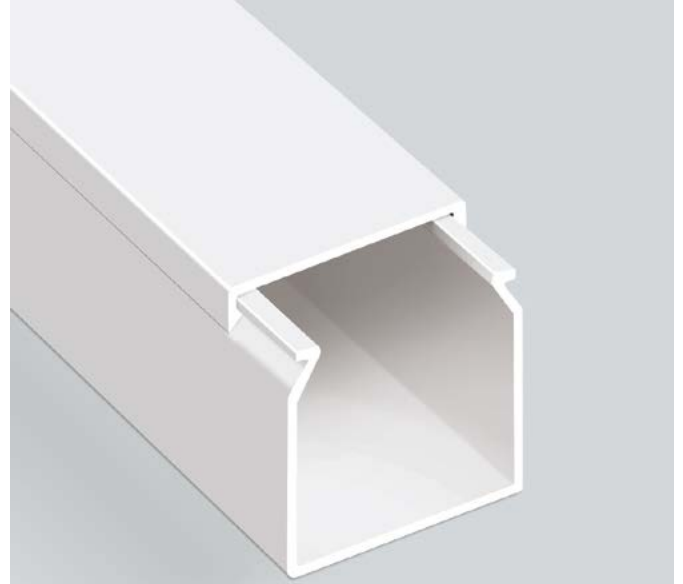

**40x40**

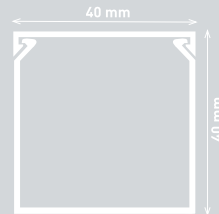

		<b>EKO</b> Seri Series	<b>MEKS</b> Seri Series	<b>CANALEX</b> Seri Series
Ürün Kodu	Product Code	001 014 040040 20 00	001 002 040040 20 00	001 156 040040 20 00
Ambalaj Şekli	Packing Type	Kutu - Box	Kutu - Box	Kutu - Box
Adet / m	Quantity / m	50 m	50 m	50 m
Ağırlık	Weight	15,500 kg	15,500 kg	14,150 kg
m <sup>3</sup> /	Volume	0,09272	0,09272	0,09272

**AKSESUARLAR - ACCESSORIES**

	Kod Code	Ürün Product	Adet Quantity	Ağırlık Weight	m <sup>3</sup> Volume
	001 039 040040 01 00	Hareketli İç Köşe Internal Corner Live	18	0,540 kg	0,00289
	001 040 040040 01 00	Hareketli Dış Köşe External Corner Live	16	0,496 kg	0,00289
	001 041 040040 00 00	T Köşe T Corner	48	1,415 kg	0,01011
	001 042 040040 00 00	90° L Köşe 90° L Corner	60	1,488 kg	0,01011
	001 043 040040 00 00	Ek Parça Connector	100	0,800 kg	0,00937
	001 044 040040 00 00	Uç Tapa Blind Cap	50	0,350 kg	0,00182

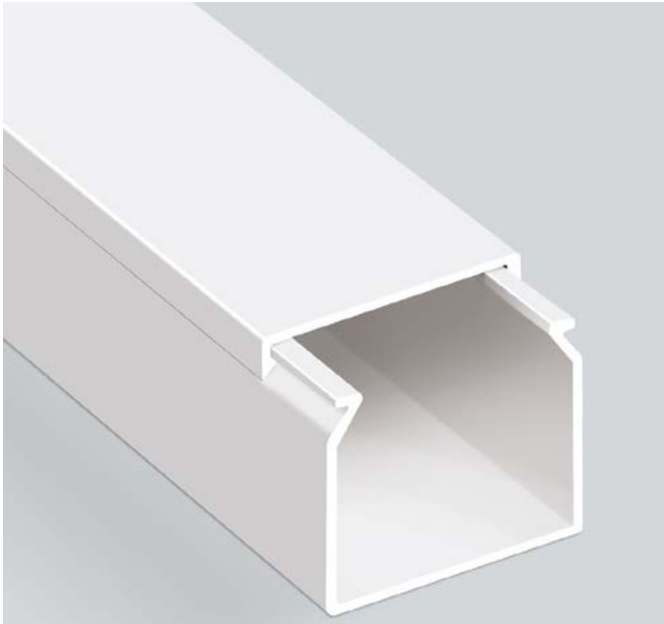
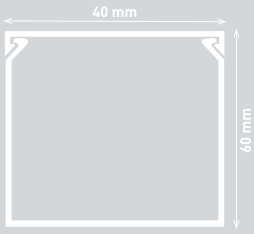
**40x60****Aksesuarsız**  
Without Accessories**EKO** Serisi Series**MEKS** Serisi Series

Ürün Kodu	Product Code	001 014 040060 20 00	001 002 040060 20 00
Ambalaj Şekli	Packing Type	Kutu - Box	Kutu - Box
Adet / m	Quantity / m	40 m	40 m
Ağırlık	Weight	21,518 kg	21,520 kg
m <sup>3</sup> /	Volume	0,11029	0,11029

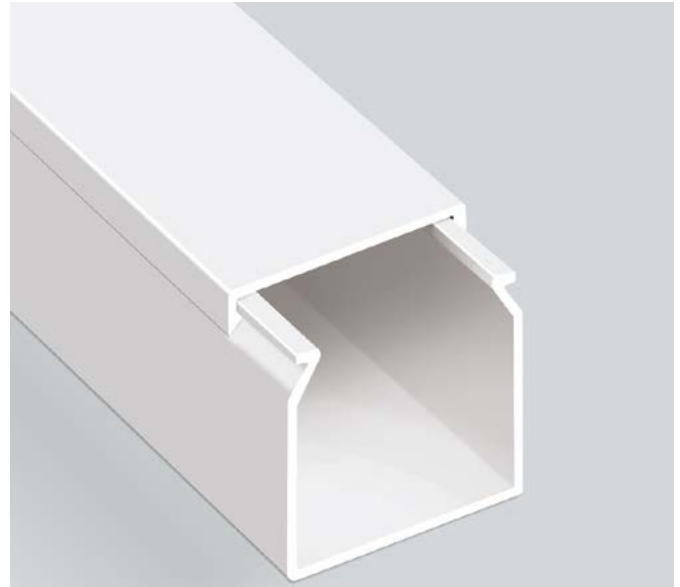
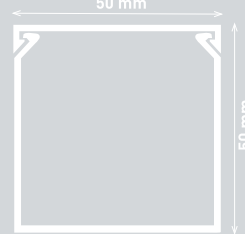
**50x50****Aksesuarsız**  
Without Accessories**EKO** Serisi Series

Ürün Kodu	Product Code	001 014 050050 20 00
Ambalaj Şekli	Packing Type	Kutu - Box
Adet / m	Quantity / m	30 m
Ağırlık	Weight	14,052 kg
m <sup>3</sup> /	Volume	0,09272





**60x25**

**Bölmeli**  
Partitioned

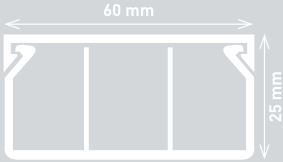

		<b>EKO</b> Seri Si Series	<b>MEKS</b> Seri Si Series
Ürün Kodu	Product Code	001 014 690025 20 00	001 002 690025 20 00
Ambalaj Şekli	Packing Type	Kutu - Box	Kutu - Box
Adet / m	Quantity / m	40 m	40 m
Ağırlık	Weight	17,140 kg	17,140 kg
m <sup>3</sup> /	Volume	0,07636	0,07636

**AKSESUARLAR - ACCESSORIES**

	Kod Code	Ürün Product	Adet Quantity	Ağırlık Weight	m <sup>3</sup> Volume
	001 039 060025 00 00	İç Köşe Internal Corner	48	1,192 kg	0,01011
	001 040 060025 00 00	Dış Köşe External Corner	72	1,781 kg	0,01011
	001 041 060025 00 00	T Köşe T Corner	40	1,250 kg	0,01011
	001 042 060025 00 00	90° L Köşe 90° L Corner	60	2,190 kg	0,01008
	001 043 060060 00 00	Ek Parça Connector	25	0,372 kg	0,00293
	001 044 060025 00 00	Uç Tapa Blind Cap	50	0,510 kg	0,00293
	001 047 017421 00 00	PM Kasası 1'li Socket Assembly Frame Single	12	1,290 kg	0,00600

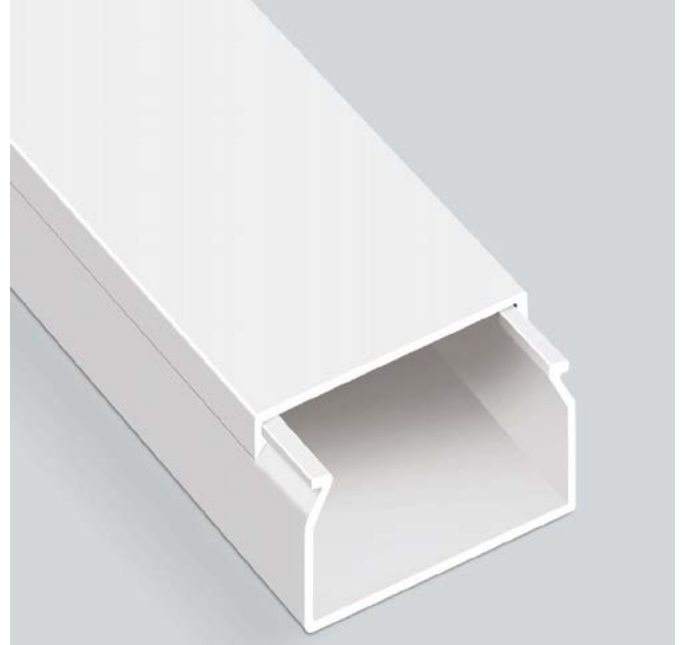

**60x40**



		<b>EKO</b> Seri Si Series	<b>MEKS</b> Seri Si Series	<b>CANALEX</b> Seri Si Series
Ürün Kodu	Product Code	001 014 060040 20 00	001 002 060040 20 00	001 156 060040 20 00
Ambalaj Şekli	Packing Type	Kutu - Box	Kutu - Box	Kutu - Box
Adet / m	Quantity / m	40 m	40 m	40 m
Ağırlık	Weight	16,400 kg	16,400 kg	15,518 kg
m <sup>3</sup> /	Volume	0,11029	0,11029	0,11029





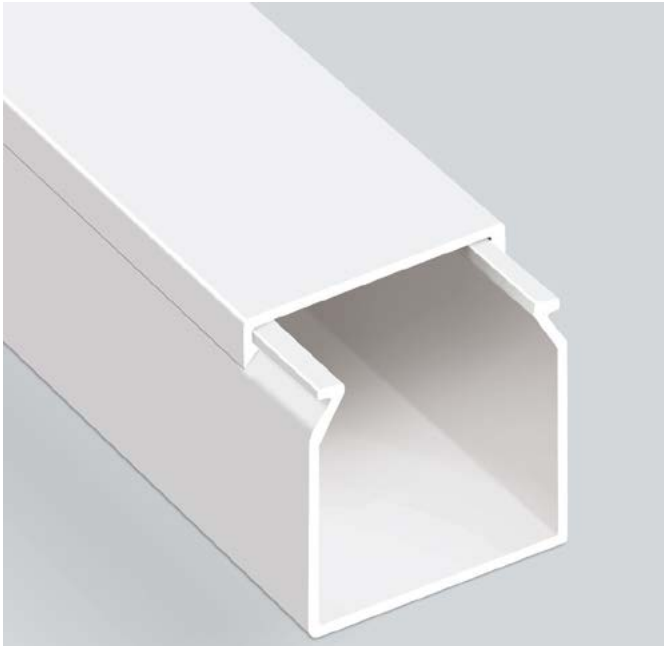
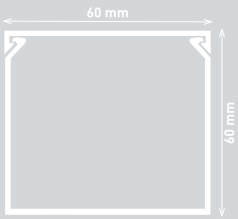

**AKSESUARLAR - ACCESSORIES**

	Kod Code	Ürün Product	Adet Quantity	Ağırlık Weight	m <sup>3</sup> Volume
	001 039 060040 00 00	İç Köşe Internal Corner	26	1,160 kg	0,01011
	001 040 060040 00 00	Dış Köşe External Corner	32	1,225 kg	0,01011
	001 041 060040 00 00	T Köşe T Corner	32	1,180 kg	0,01011
	001 042 060040 00 00	90° L Köşe 90° L Corner	40	1,375 kg	0,01011
	001 043 060060 00 00	Ek Parça Connector	25	0,372 kg	0,00293
	001 044 060040 00 00	Uç Tapa Blind Cap	30	0,975 kg	0,00294

**60x60**

		<b>EKO</b> Serişi Series	<b>MEKS</b> Serişi Series	<b>CANALEX</b> Serişi Series
Ürün Kodu	Product Code	001 014 060060 20 00	001 002 060060 20 00	001 156 060060 20 00
Ambalaj Şekli	Packing Type	Kutu - Box	Kutu - Box	Kutu - Box
Adet / m	Quantity / m	32 m	32 m	32 m
Ağırlık	Weight	20,445 kg	20,445 kg	18,717 kg
m <sup>3</sup> /	Volume	0,13392	0,13392	0,13392

**AKSESUARLAR - ACCESSORIES**

	Kod Code	Ürün Product	Adet Quantity	Ağırlık Weight	m <sup>3</sup> Volume
	001 039 060060 01 00	Hareketli İç Köşe Internal Corner Live	16	1,123 kg	0,01011
	001 040 060060 01 00	Hareketli Dış Köşe External Corner Live	16	1,361 kg	0,01011
	001 041 060060 00 00	T Köşe T Corner	20	1,406 kg	0,01011
	001 042 060060 00 00	90° L Köşe 90° L Corner	24	1,691 kg	0,01011
	001 043 060060 00 00	Ek Parça Connector	25	0,372 kg	0,00293
	001 044 060060 00 00	Uç Tapa Blind Cap	30	0,975 kg	0,00294

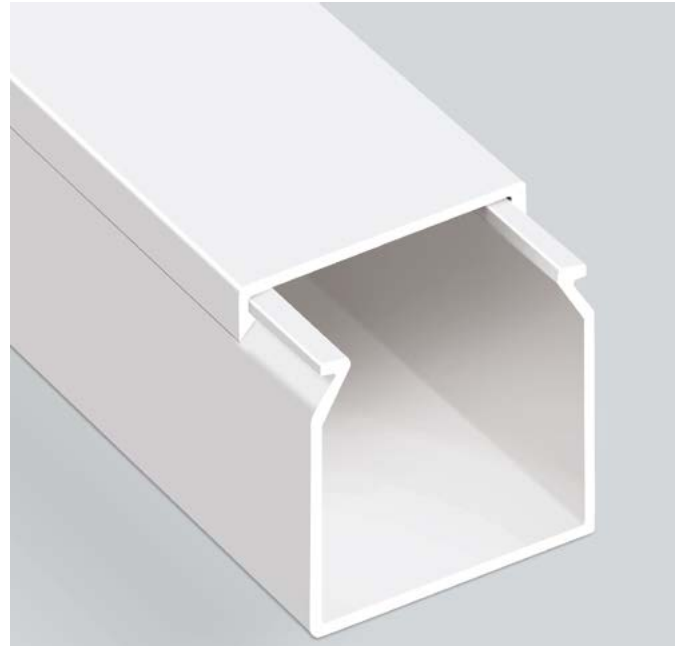
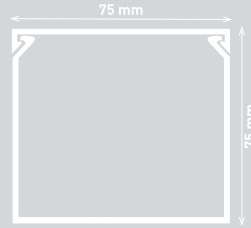
**75x75****Aksesuarsız**  
Without Accessories

		<b>EKO</b> Serişi Series
Ürün Kodu	Product Code	001 014 075075 20 00
Ambalaj Şekli	Packing Type	Kutu - Box
Adet / m	Quantity / m	28 m
Ağırlık	Weight	25,153 kg
m <sup>3</sup> /	Volume	0,13392



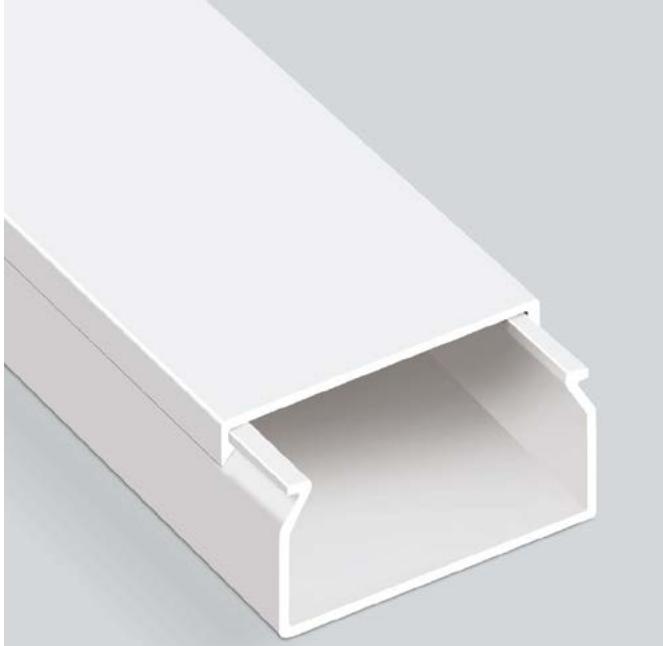

**80x40**



		<b>EKO</b> Serisi Series	<b>MEKS</b> Serisi Series	<b>CANALEX</b> Serisi Series
Ürün Kodu	Product Code	001 014 080040 20 00	001 002 080040 20 00	001 156 080040 20 00
Ambalaj Şekli	Packing Type	Kutu - Box	Kutu - Box	Kutu - Box
Adet / m	Quantity / m	30 m	30 m	30 m
Ağırlık	Weight	19,518 kg	19,518 kg	17,118 kg
m <sup>3</sup> /	Volume	0,11029	0,11029	0,11029

**AKSESUARLAR - ACCESSORIES**

	Kod Code	Ürün Product	Adet Quantity	Ağırlık Weight	m <sup>3</sup> Volume
	001 039 080040 00 00	İç Köşe Internal Corner	18	1,107 kg	0,01011
	001 040 080040 00 00	Dış Köşe External Corner	8	0,839 kg	0,00653
	001 041 080040 00 00	T Köşe T Corner	12	1,194 kg	0,01011
	001 042 080040 00 00	90° L Köşe 90° L Corner	16	1,386 kg	0,01011
	001 043 080040 00 00	Ek Parça Connector	100	1,200 kg	0,00937
	001 044 080040 00 00	Uç Tapa Blind Cap	60	0,887 kg	0,00293

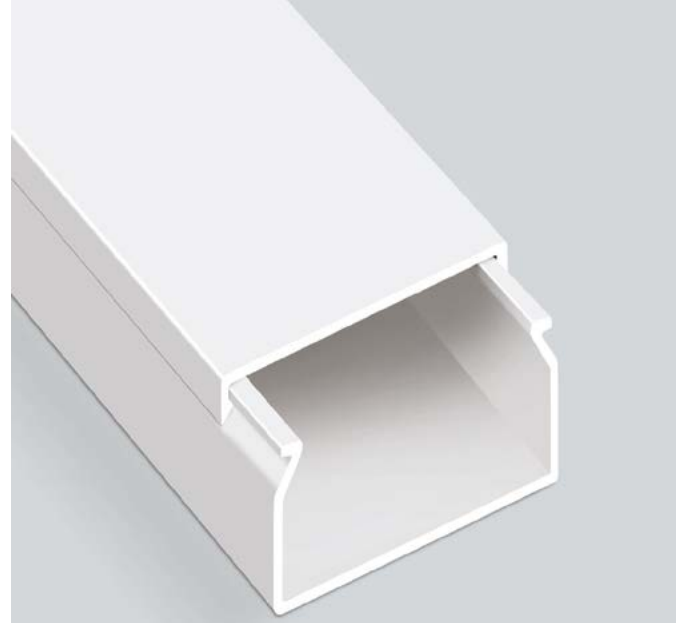

**80x60**

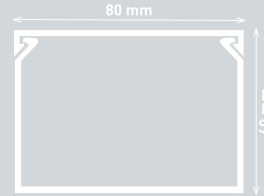

		<b>EKO</b> Serisi Series	<b>MEKS</b> Serisi Series	<b>CANALEX</b> Serisi Series
Ürün Kodu	Product Code	001 014 080060 20 00	001 002 080060 20 00	001 156 080060 20 00
Ambalaj Şekli	Packing Type	Kutu - Box	Kutu - Box	Kutu - Box
Adet / m	Quantity / m	24 m	24 m	24 m
Ağırlık	Weight	17,232 kg	17,232 kg	16,157 kg
m <sup>3</sup> /	Volume	0,13392	0,13392	0,13392

**AKSESUARLAR - ACCESSORIES**

	Kod Code	Ürün Product	Adet Quantity	Ağırlık Weight	m <sup>3</sup> Volume
	001 039 080060 00 00	İç Köşe Internal Corner	12	0,980 kg	0,01011
	001 040 080060 00 00	Dış Köşe External Corner	8	0,898 kg	0,00653
	001 041 080060 00 00	T Köşe T Corner	10	1,237 kg	0,01011
	001 042 080060 00 00	90° L Köşe 90° L Corner	12	1,287 kg	0,01010
	001 043 080060 00 00	Ek Parça Connector	80	1,120 kg	0,00937
	001 044 080060 00 00	Uç Tapa Blind Cap	48	0,944 kg	0,00293

**100x40****Kilitleme Aparatlı**  
With Locking Apparatus

		<b>EKO</b> Seri Series	<b>MEKS</b> Seri Series	<b>CANALEX</b> Seri Series
Ürün Kodu	Product Code	001 014 100040 20 00	001 002 100040 20 00	001 156 100040 20 00
Ambalaj Şekli	Packing Type	Kutu - Box	Kutu - Box	Kutu - Box
Adet / m	Quantity / m	24 m	24 m	24 m
Ağırlık	Weight	18,648 kg	21,918 kg	16,380 kg
m <sup>3</sup> /	Volume	0,11029	0,11029	0,11029

**AKSESUARLAR - ACCESSORIES**

	Kod Code	Ürün Product	Adet Quantity	Ağırlık Weight	m <sup>3</sup> Volume
	001 013 100040 20 00	Ara Bölme Partition	200 m	21,050 kg	0,05040
	001 039 100040 00 00	İç Köşe Internal Corner	8	0,795 kg	0,01011
	001 039 100040 01 00	İç Köşe Hareketli Internal Corner Live	10	1,651 kg	0,01312
	001 040 100040 00 00	Dış Köşe External Corner	8	0,905 kg	0,00653
	001 040 100040 01 00	Dış Köşe Hareketli External Corner Live	10	0,959 kg	0,00817
	001 041 100040 00 00	T Köşe T Corner	12	1,344 kg	0,01010
	001 042 100040 00 00	90° L Köşe 90° L Corner	12	1,233 kg	0,01011
	001 043 100060 00 00	Ek Parça Connector	100	0,966 kg	0,01011
	001 044 100060 00 00	Uç Tapa Blind Cap	16	0,396 kg	0,00182
	001 050 030004 00 00	Kilitleme Aparatı Locking Apparatus	100	0,280 kg	0,00100

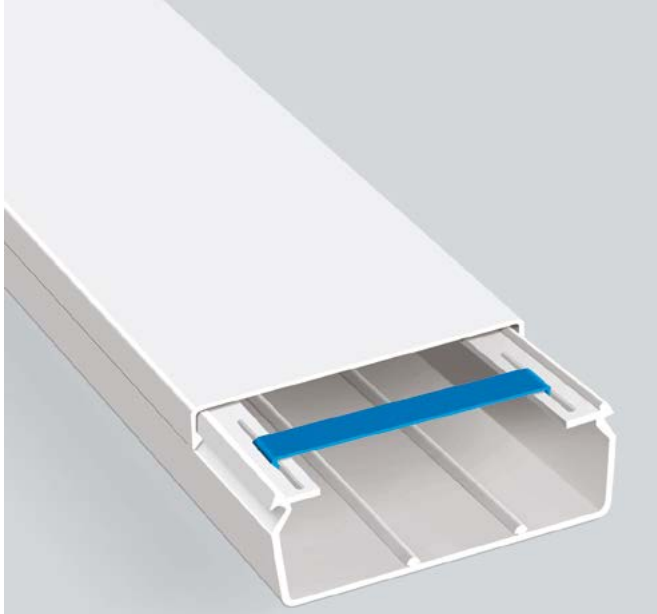

**100x48**

**Kilitleme Aparatlı**  
With Locking Apparatus

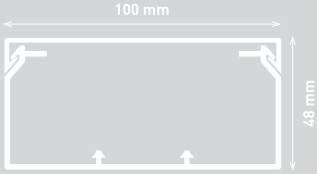

**MEKS** Serisi Series

Ürün Kodu	Product Code	001 002 100048 20 00
Ambalaj Şekli	Packing Type	Kutu - Box
Adet / m	Quantity / m	24 m
Ağırlık	Weight	25,757 kg
m <sup>3</sup> /	Volume	0,13392

**AKSESUARLAR - ACCESSORIES**

Kod Code	Ürün Product	Adet Quantity	Ağırlık Weight	m <sup>3</sup> Volume
001 013 100048 20 00	Ara Bölme Partition	150 m	19,605 kg	0,07500
001 039 100048 00 00	İç Köşe Internal Corner	8	0,915 kg	0,01011
001 039 100060 01 00	İç Köşe Hareketli Internal Corner Live	10	1,190 kg	0,01312
001 040 100048 00 00	Dış Köşe External Corner	8	0,918 kg	0,00653
001 040 100060 01 00	Dış Köşe Hareketli External Corner Live	10	1,120 kg	0,01011
001 041 100048 00 00	T Köşe T Corner	8	1,008 kg	0,01011
001 042 100048 00 00	90° L Köşe 90° L Corner	8	0,936 kg	0,01011
001 043 100060 00 00	Ek Parça Connector	100	0,966 kg	0,01011
001 044 100060 00 00	Uç Tapa Blind Cap	20	0,529 kg	0,00293
001 050 030004 00 00	Kilitleme Aparatı Locking Apparatus	100	0,280 kg	0,00100

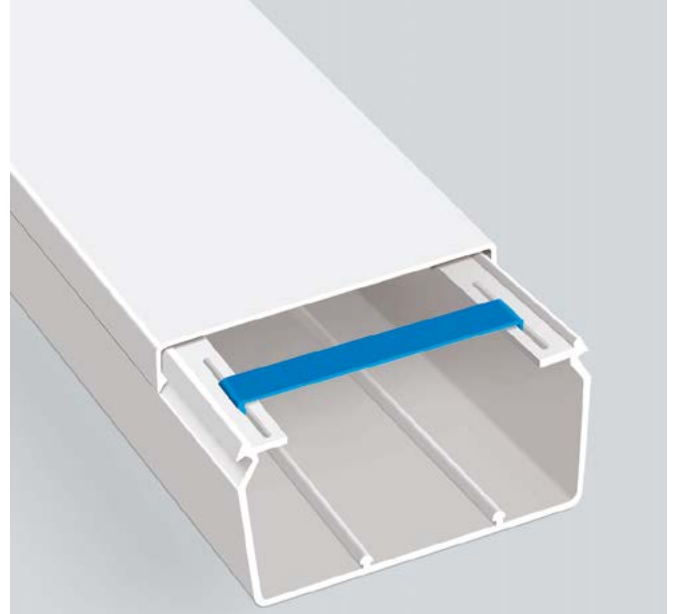

**100x60**

**Kilitleme Aparatlı**  
With Locking Apparatus

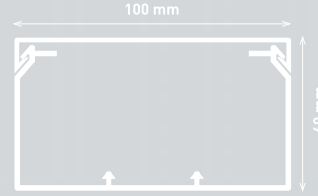

Ürün Kodu	Product Code	EKO	MEKS	CANALEX
		Serisi Series	Serisi Series	Serisi Series
001 014 100060 20 00	001 002 100060 20 00	001 156 100060 20 00		
Ambalaj Şekli	Packing Type	Kutu - Box	Kutu - Box	Kutu - Box
Adet / m	Quantity / m	20 m	20 m	20 m
Ağırlık	Weight	19,700 kg	22,757 kg	18,557 kg
m <sup>3</sup> /	Volume	0,13392	0,13392	0,13392

**AKSESUARLAR - ACCESSORIES**

Kod Code	Ürün Product	Adet Quantity	Ağırlık Weight	m <sup>3</sup> Volume
001 013 100060 20 00	Ara Bölme Partition	130 m	19,360 kg	0,07956
001 039 100060 00 00	İç Köşe Internal Corner	8	0,969 kg	0,01011
001 039 100060 01 00	İç Köşe Hareketli Internal Corner Live	10	1,190 kg	0,01312
001 040 100060 00 00	Dış Köşe External Corner	8	0,988 kg	0,00653
001 040 100060 01 00	Dış Köşe Hareketli External Corner Live	10	1,120 kg	0,01011
001 041 100060 00 00	T Köşe T Corner	8	1,067 kg	0,01011
001 042 100060 00 00	90° L Köşe 90° L Corner	8	1,080 kg	0,01011
001 043 100060 00 00	Ek Parça Connector	100	0,966 kg	0,01011
001 044 100060 00 00	Uç Tapa Blind Cap	20	0,529 kg	0,00293
001 050 030004 00 00	Kilitleme Aparatı Locking Apparatus	100	0,280 kg	0,00100

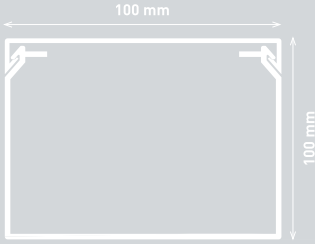

**100x100****Aksesuarsız**  
Without Accessories**EKO** Serisi Series

Ürün Kodu	Product Code	001 014 100100 20 00
Ambalaj Şekli	Packing Type	Kutu - Box
Adet / m	Quantity / m	20 m
Ağırlık	Weight	29,017 kg
m <sup>3</sup> /	Volume	0,13392

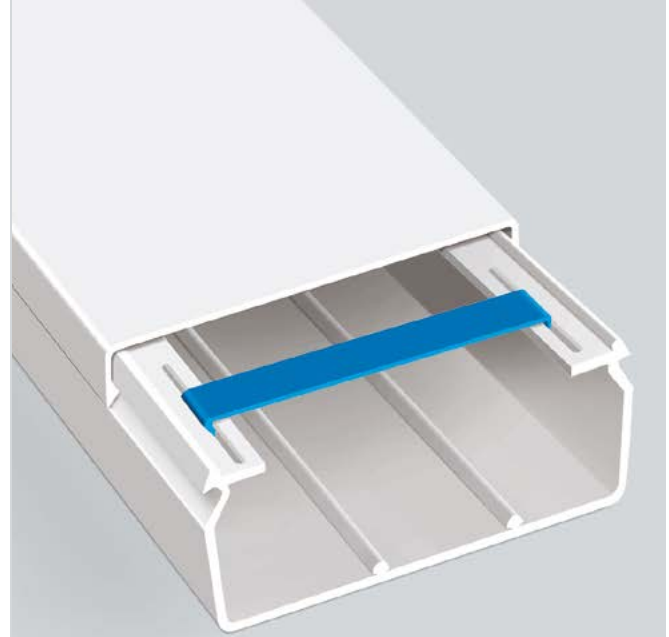
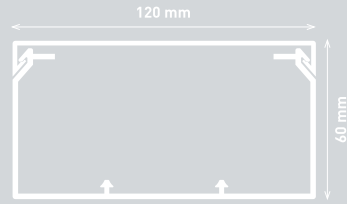
**120x60****Kilitleme Aparatlı**  
With Locking Apparatus

		<b>EKO</b> Serisi Series	<b>MEKS</b> Serisi Series
Ürün Kodu	Product Code	001 014 120060 20 00	001 002 120060 20 00
Ambalaj Şekli	Packing Type	Kutu - Box	Kutu - Box
Adet / m	Quantity / m	16 m	16 m
Ağırlık	Weight	21,949 kg	21,949 kg
m <sup>3</sup> /	Volume	0,13392	0,13392

**AKSESUARLAR - ACCESSORIES**

	Kod Code	Ürün Product	Adet Quantity	Ağırlık Weight	m <sup>3</sup> Volume
	001 013 120060 20 00	Ara Bölme Partition	130 m	20,010 kg	0,07956
	001 039 120060 00 00	İç Köşe Internal Corner	8	0,939 kg	0,01011
	001 040 120060 00 00	Dış Köşe External Corner	8	0,860 kg	0,00653
	001 041 120060 00 00	T Köşe T Corner	8	1,050 kg	0,01011
	001 042 120060 00 00	90° L Köşe 90° L Corner	8	1,116 kg	0,01011
	001 043 120060 00 00	Ek Parça Connector	50	1,229 kg	0,01011
	001 044 120060 00 00	Uç Tapa Blind Cap	20	0,612 kg	0,00293
	001 050 030004 00 00	Kilitleme Aparatı Locking Apparatus			

# DIŐAN KAPAKLI 100'LÜK SERİ PRİZ MONTAJ SETLERİ

## External Cover 100 Series Plug Socket Assembly Sets

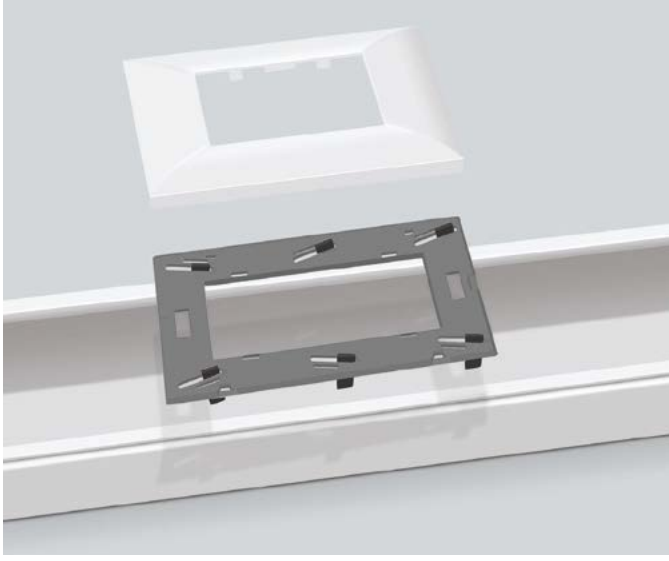

**45x45**  
**Tekli Çerçeve**  
**Single Frame**

Ürün Kodu	Product Code	001 047 040001 00 00
Ambalaj Şekli	Packing Type	Kutu - Box
Adet / m	Quantity / m	20 ad.
Ağırlık	Weight	1,319 kg
m <sup>3</sup> /	Volume	0,00628

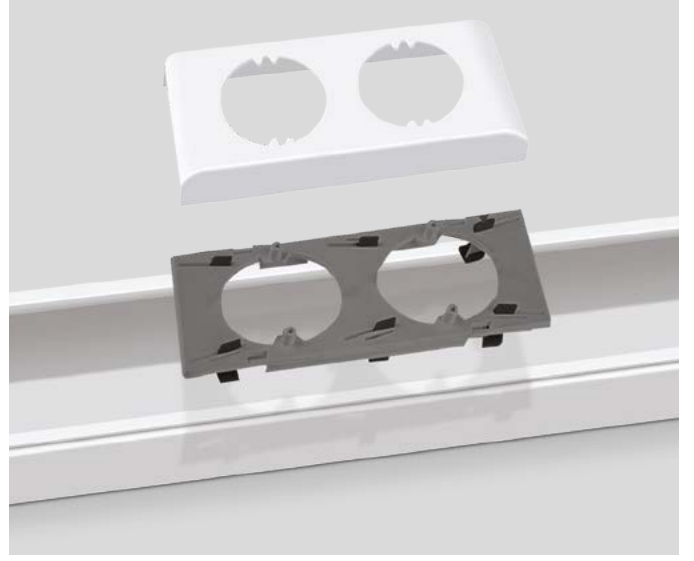

**55x55**  
**Tekli Çerçeve**  
**Single Frame**

Ürün Kodu	Product Code	001 047 020001 00 00
Ambalaj Şekli	Packing Type	Kutu - Box
Adet / m	Quantity / m	20 ad.
Ağırlık	Weight	1,400 kg
m <sup>3</sup> /	Volume	0,00816

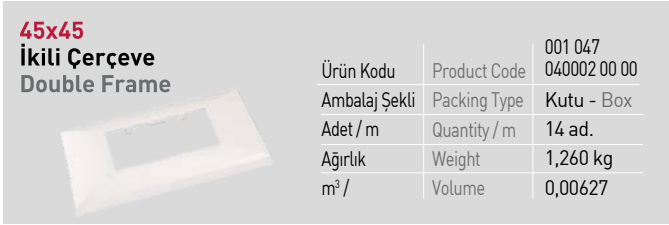

**45x45**  
**İkili Çerçeve**  
**Double Frame**

Ürün Kodu	Product Code	001 047 040002 00 00
Ambalaj Şekli	Packing Type	Kutu - Box
Adet / m	Quantity / m	14 ad.
Ağırlık	Weight	1,260 kg
m <sup>3</sup> /	Volume	0,00627

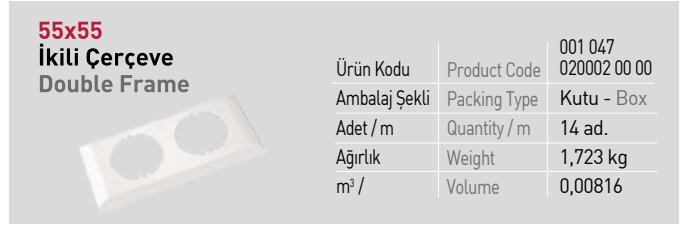

**55x55**  
**İkili Çerçeve**  
**Double Frame**

Ürün Kodu	Product Code	001 047 020002 00 00
Ambalaj Şekli	Packing Type	Kutu - Box
Adet / m	Quantity / m	14 ad.
Ağırlık	Weight	1,723 kg
m <sup>3</sup> /	Volume	0,00816

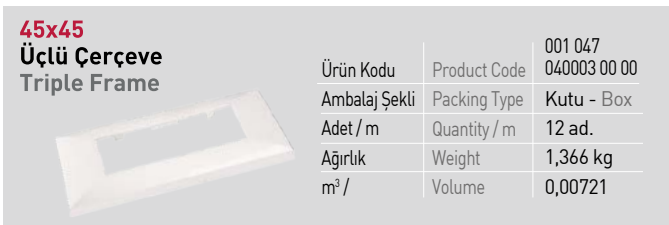

**45x45**  
**Üçlü Çerçeve**  
**Triple Frame**

Ürün Kodu	Product Code	001 047 040003 00 00
Ambalaj Şekli	Packing Type	Kutu - Box
Adet / m	Quantity / m	12 ad.
Ağırlık	Weight	1,366 kg
m <sup>3</sup> /	Volume	0,00721

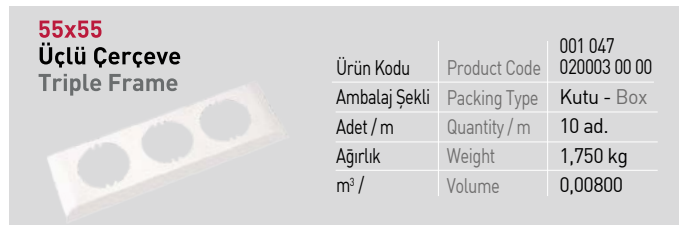

**55x55**  
**Üçlü Çerçeve**  
**Triple Frame**

Ürün Kodu	Product Code	001 047 020003 00 00
Ambalaj Şekli	Packing Type	Kutu - Box
Adet / m	Quantity / m	10 ad.
Ağırlık	Weight	1,750 kg
m <sup>3</sup> /	Volume	0,00800

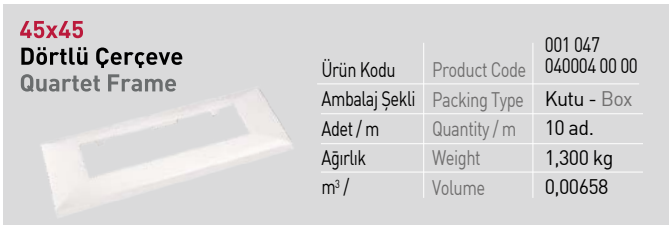

**45x45**  
**Dörtlü Çerçeve**  
**Quartet Frame**

Ürün Kodu	Product Code	001 047 040004 00 00
Ambalaj Şekli	Packing Type	Kutu - Box
Adet / m	Quantity / m	10 ad.
Ağırlık	Weight	1,300 kg
m <sup>3</sup> /	Volume	0,00658



**Kanal Kilitleme Aparatı**

It prevents stretching which could occur in time

**001 050 030004 00 00**

Kanalda zamanla oluşabilecek esnemelerin önüne geçer.

Prevents back last that could occur in the trunking.

## Meksplus serisi içten kapaklı kanallar

Meksplus Series  
Internal Cover Cable  
Trunking



**içten Kapaklı**  
Intrinsic Cover



**Koruma Bantlı**  
Protecting Foil



**100x37**



		<b>EKO</b> Serisi - Series	<b>MEKS</b> Serisi - Series	<b>MEKSPLUS</b> Serisi - Series
Ürün Kodu	Product Code	001 014 100037 20 00	001 002 100037 20 00	001 003 100037 20 00
Ambalaj Şekli	Packing Type	Kutu - Box	Kutu - Box	Kutu - Box
Adet / m	Quantity / m	30 m	30 m	30 m
Ağırlık	Weight	28,017 kg	29,067 kg	29,067 kg
m <sup>3</sup> /	Volume	0,13392	0,13392	0,13392



#### AKSESUARLAR - ACCESSORIES

	Kod Code	Ürün Product	Adet Quantity	Ağırlık Weight	m <sup>3</sup> Volume
	001 013 100037 20 00	Ara Bölme Partition	200 m	19,650 kg	0,05040
	001 039 100037 00 00	İç Köşe Internal Corner	12	0,807 kg	0,01011
	001 039 100050 01 00	İç Köşe Hareketli Internal Corner Live	12	1,020 kg	0,00960
	001 040 100037 00 00	Dış Köşe External Corner	8	0,723 kg	0,00653
	001 040 100050 01 00	Dış Köşe Hareketli External Corner Live	8	0,880 kg	0,00653
	001 041 100037 00 00	T Köşe T Corner	14	1,418 kg	0,01365
	001 042 100037 00 00	90° L Köşe 90° L Corner	14	1,400 kg	0,01365
	001 043 100050 00 00	Ek Parça Connector	100	1,590 kg	0,01000
	001 044 100037 00 00	Uç Tapa Blind Cap	50	0,790 kg	0,00293

**Koruma Bantlı**  
Protecting Foil**100x41**

		<b>MEKS</b> Serisi - Series	<b>MEKSPLUS</b> Serisi - Series
Ürün Kodu	Product Code	001 002 100041 20 00	001 003 100041 20 00
Ambalaj Şekli	Packing Type	Kutu - Box	Kutu - Box
Adet / m	Quantity / m	24 m	24 m
Ağırlık	Weight	21,678 kg	21,678 kg
m <sup>3</sup> /	Volume	0,11029	0,11029

**AKSESUARLAR - ACCESSORIES**

	Kod Code	Ürün Product	Adet Quantity	Ağırlık Weight	m <sup>3</sup> Volume
	001 013 100040 20 00	Ara Bölme Partition	200 m	21,050 kg	0,05040
	001 039 100050 00 00	İç Köşe Internal Corner	8	0,600 kg	0,01011
	001 039 100050 01 00	İç Köşe Hareketli Internal Corner Live	12	1,020 kg	0,00960
	001 040 100050 00 00	Dış Köşe External Corner	8	0,880 kg	0,00653
	001 040 100050 01 00	Dış Köşe Hareketli External Corner Live	10	1,140 kg	0,01000
	001 041 100050 00 00	T Köşe T Corner	10	1,000 kg	0,01364
	001 042 100050 00 00	90° L Köşe 90° L Corner	10	1,012 kg	0,01364
	001 043 100050 00 00	Ek Parça Connector	100	1,590 kg	0,01000
	001 044 100050 00 00	Uç Tapa Blind Cap	40	0,736 kg	0,00400

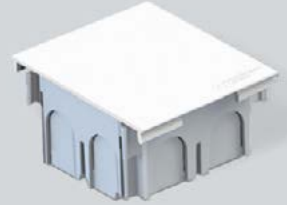
**Koruma Bantlı**  
Protecting Foil**100x50****Kanal içi Küp Buat**  
Duct Junction Cube

		<b>CANALEX</b> Serisi - Series	<b>EKO</b> Serisi - Series	<b>MEKS</b> Serisi - Series	<b>MEKSPLUS</b> Serisi - Series
Ürün Kodu	Product Code	001 156 100050 20 00	001 014 100050 20 00	001 002 100050 20 00	001 003 100050 20 00
Ambalaj Şekli	Packing Type	Kutu Box	Kutu Box	Kutu Box	Kutu Box
Adet / m	Quantity / m	20 m	20 m	20 m	20 m
Ağırlık	Weight	17,400 kg	17,880 kg	21,000 kg	21,000 kg
m <sup>3</sup> /	Volume	0,11554	0,11554	0,11554	0,11554

**AKSESUARLAR - ACCESSORIES**

	Kod Code	Ürün Product	Adet Quantity	Ağırlık Weight	m <sup>3</sup> Volume
	001 013 100048 20 00	Ara Bölme Partition	150 m	19,605 kg	0,07500
	001 039 100050 00 00	İç Köşe Internal Corner	8	0,600 kg	0,01011
	001 039 100050 01 00	İç Köşe Hareketli Internal Corner Live	10	0,800 kg	0,00937
	001 040 100050 00 00	Dış Köşe External Corner	8	0,896 kg	0,00937
	001 040 100050 01 00	Dış Köşe Hareketli External Corner Live	10	1,140 kg	0,01000
	001 041 100050 00 00	T Köşe T Corner	10	1,000 kg	0,01364
	001 042 100050 00 00	90° L Köşe 90° L Corner	10	1,012 kg	0,01364
	001 043 100050 00 00	Ek Parça Connector	100	1,590 kg	0,01000
	001 044 100050 00 00	Uç Tapa Blind Cap	40	0,736 kg	0,00400
	001 043 100050 01 00	Ek parça (3'lü Set) Connector (3 set)	100	1,300 kg	0,00937
	001 046 195100 00 00	Kanal içi Küp Buat Duct Junction Cube	25	1,408 kg	0,00828



**Koruma Bantlı**  
Protecting Foil

**100x50**

**Kaidesiz**  
Compatible With Mounting  
Without Base

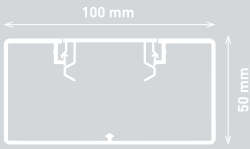

**MEKSPLUS** Serisi

Ürün Kodu	Product Code	001 006 100050 20 00
Ambalaj Şekli	Packing Type	Kutu - Box
Adet / m	Quantity / m	20 m
Ağırlık	Weight	20,168 kg
m <sup>3</sup> /	Volume	0,11554

**AKSESUARLAR - ACCESSORIES**

Kod Code	Ürün Product	Adet Quantity	Ağırlık Weight	m <sup>3</sup> Volume
001 013 100048 20 00	Ara Bölme Partition	150 m	19,605 kg	0,07500
001 039 100051 00 00	İç Köşe Internal Corner	8	0,600 kg	0,01011
001 040 100051 00 00	Dış Köşe External Corner	8	0,880 kg	0,00653
001 041 100051 00 00	T Köşe T Corner	10	1,150 kg	0,01312
001 042 100051 00 00	90° L Köşe 90° L Corner	10	1,080 kg	0,01312
001 043 100051 00 00	Ek Parça Connector	100	1,585 kg	0,01000
001 044 100051 00 00	Uç Tapa Blind Cap	40	0,735 kg	0,00400
001 888 100050 00 00	Kilitleme Aparatı Locking Apparatus	50	0,385 kg	0,00282



**120x70**

**Aksesuarsız**  
Without Accessories

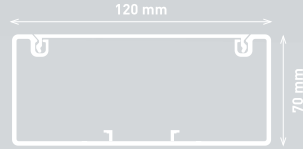

**MEKSPLUS** Serisi

Ürün Kodu	Product Code	001 003 120070 20 00
Ambalaj Şekli	Packing Type	Kutu - Box
Adet / m	Quantity / m	16 m
Ağırlık	Weight	25,673 kg
m <sup>3</sup> /	Volume	0,13392

**AKSESUARLAR - ACCESSORIES**

Kod Code	Ürün Product	Adet Quantity	Ağırlık Weight	m <sup>3</sup> Volume
001 013 120070 20 00	Ara Bölme Partition	60 m	10,160	0,07956

**100x50**

**Kaidesiz**  
Compatible With Mounting  
Without Base

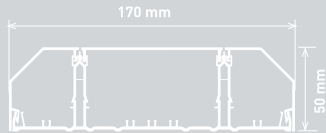

**Koruma Bantlı**  
Protecting Foil**170x50****MEKPLUS** Serisi Series

Ürün Kodu	Product Code	001 003 170050 20 00
Ambalaj Şekli	Packing Type	Kutu - Box
Adet / m	Quantity / m	12 m
Ağırlık	Weight	25,560 kg
m <sup>3</sup> /	Volume	0,11551

**AKSESUARLAR - ACCESSORIES**

Kod Code	Ürün Product	Adet Quantity	Ağırlık Weight	m <sup>3</sup> Volume
 001 039 170050 00 00	İç Köşe Internal Corner	32	2,848 kg	0,07500
 001 040 170050 00 00	Dış Köşe External Corner	8	0,704 kg	0,01011
 001 041 170050 00 00	T Köşe T Corner	16	3,749 kg	0,00653
 001 042 170050 00 00	90° L Köşe 90° L Corner	16	2,997 kg	0,01364
 001 043 170050 00 00	Ek Parça Connector	125	19,000 kg	0,01364
 001 044 170050 00 00	Uç Tapa Blind Cap	125	4,250 kg	0,01000

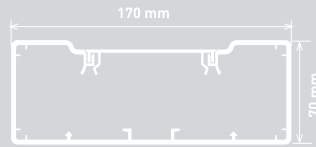
**170x70****Aksesuarsız**  
Without Accessories**MEKPLUS** Serisi Series

Ürün Kodu	Product Code	001 003 170070 20 00
Ambalaj Şekli	Packing Type	Kutu - Box
Adet / m	Quantity / m	12 m
Ağırlık	Weight	29,365 kg
m <sup>3</sup> /	Volume	0,11551

**AKSESUARLAR - ACCESSORIES**

Kod Code	Ürün Product	Adet Quantity	Ağırlık Weight	m <sup>3</sup> Volume
 001 013 120070 20 00	Ara Bölme Partition	60 m	10,160	0,07956



**250x70**

**Aksesuarsız**  
Without Accessories



**MEKSPLUS** Serisi Series

Ürün Kodu	Product Code	001 003 250070 20 00
Ambalaj Şekli	Packing Type	Kutu - Box
Adet / m	Quantity / m	8 m
Ağırlık	Weight	22,952 kg
m <sup>3</sup> /	Volume	0,16665

**Priz Montaj Setsiz**  
Without Plug Socket Assembly Set



**250x70**

**Bölmeli - Partitioned**  
**Aksesuarsız - Without Accessories**

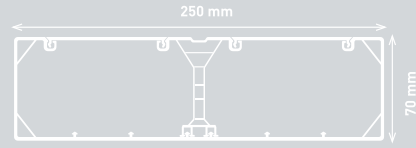

**MEKSPLUS** Serisi Series

Ürün Kodu	Product Code	001 003 250970 20 00
Ambalaj Şekli	Packing Type	Kutu - Box
Adet / m	Quantity / m	8 m
Ağırlık	Weight	25,848 kg
m <sup>3</sup> /	Volume	0,16665

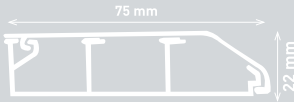

**75x22****MEKS** Serisi Series

Ürün Kodu	Product Code	001 002 975022 20 00
Ambalaj Şekli	Packing Type	Kutu - Box
Adet / m	Quantity / m	50 m
Ağırlık	Weight	33,743 kg
m <sup>3</sup> /	Volume	0,09272

**AKSESUARLAR - ACCESSORIES**

Kod Code	Ürün Product	Adet Quantity	Ağırlık Weight	m <sup>3</sup> Volume
 001 039 075022 00 00	İç Köşe Internal Corner	20	0,446 kg	0,01010
 001 040 075022 00 00	Dış Köşe External Corner	20	0,471 kg	0,01010
 001 043 075022 00 00	Ek Parça Connector	100	0,500 kg	0,00290
 001 044 075022 01 00	Sağ Uç Tapa Blind Cap Right	30	0,195 kg	0,00138
 001 044 075022 02 00	Sol Uç Tapa Blind Cap Left	20	0,130 kg	0,00092

**74x20****Tam Kapaklı Bölmeli**  
Full Cover And Partitioned**EKO** Serisi Series**MEKS** Serisi Series

Ürün Kodu	Product Code	001 014 974020 20 00	001 002 974020 20 00
Ambalaj Şekli	Packing Type	Kutu - Box	Kutu - Box
Adet / m	Quantity / m	50 m	50 m
Ağırlık	Weight	29,295 kg	29,295 kg
m <sup>3</sup> /	Volume	0,09272	0,09272

**AKSESUARLAR - ACCESSORIES**

Kod Code	Ürün Product	Adet Quantity	Ağırlık Weight	m <sup>3</sup> Volume
 001 039 074020 00 00	İç Köşe Internal Corner	20	0,402 kg	0,00293
 001 040 074020 00 00	Dış Köşe External Corner	20	0,424 kg	0,00293
 001 041 074020 00 00	T Köşe T Corner	30	1,350 kg	0,01011
 001 042 074020 00 00	90° L Köşe 90° L Corner	40	1,444 kg	0,01011
 001 043 074020 00 00	Ek Parça Connector	50	0,430 kg	0,00293
 001 044 074020 00 00	Uç Tapa Blind Cap	50	0,550 kg	0,00293
 001 047 0117420 00 00	P. M Kasası Socket Assembly Frame	6	0,574 kg	0,00300
 001 047 017421 00 00	P. M Kasası 1'li Socket Assembly Frame Single	12	1,290 kg	0,00600

# İÇTEN KAPAKLI PRİZ MONTAJ SETLERİ

## Socket Assembly Adaptor for Internal Cover Trunkings

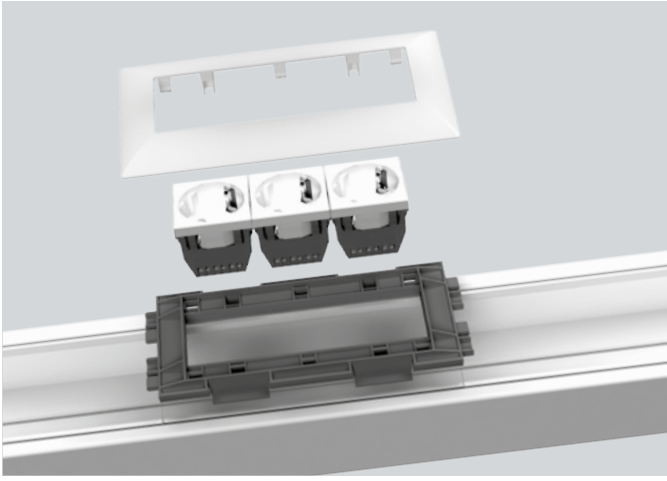

### 45x45 Tekli Çerçeve Single Frame



Ürün Kodu	Product Code	001 047 070001 00 00
Ambalaj Şekli	Packing Type	Kutu - Box
Adet / m	Quantity / m	20 m
Ağırlık	Weight	1,118 kg
m <sup>3</sup> /	Volume	0,00600

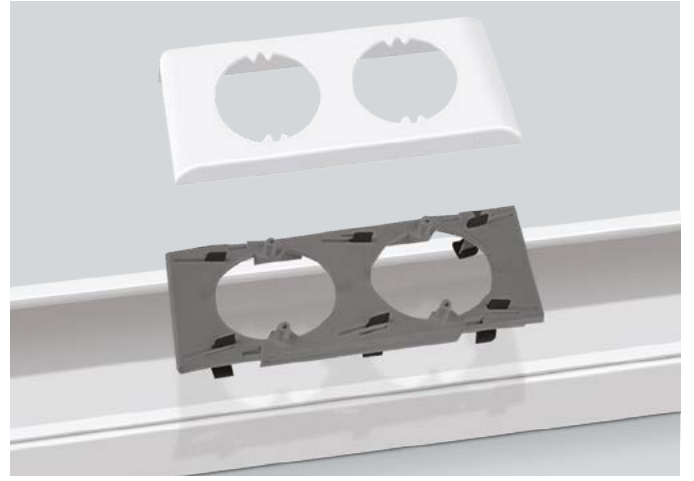

### 55x55 Tekli Çerçeve Single Frame



Ürün Kodu	Product Code	001 047 080001 00 00
Ambalaj Şekli	Packing Type	Kutu - Box
Adet / m	Quantity / m	20 m
Ağırlık	Weight	1,275 kg
m <sup>3</sup> /	Volume	0,00652

### 45x45 İkili Çerçeve Double Frame



Ürün Kodu	Product Code	001 047 070002 00 00
Ambalaj Şekli	Packing Type	Kutu - Box
Adet / m	Quantity / m	14 m
Ağırlık	Weight	1,072 kg
m <sup>3</sup> /	Volume	0,00560

### 55x55 İkili Çerçeve Double Frame



Ürün Kodu	Product Code	001 047 080002 00 00
Ambalaj Şekli	Packing Type	Kutu - Box
Adet / m	Quantity / m	14 m
Ağırlık	Weight	1,308 kg
m <sup>3</sup> /	Volume	0,00666

### 45x45 Üçlü Çerçeve Triple Frame



Ürün Kodu	Product Code	001 047 070003 00 00
Ambalaj Şekli	Packing Type	Kutu - Box
Adet / m	Quantity / m	12 m
Ağırlık	Weight	1,079 kg
m <sup>3</sup> /	Volume	0,00600

### 55x55 Üçlü Çerçeve Triple Frame



Ürün Kodu	Product Code	001 047 080003 00 00
Ambalaj Şekli	Packing Type	Kutu - Box
Adet / m	Quantity / m	10 m
Ağırlık	Weight	1,212 kg
m <sup>3</sup> /	Volume	0,00667

### 45x45 Dörtlü Çerçeve Quartet Frame



Ürün Kodu	Product Code	001 047 070004 00 00
Ambalaj Şekli	Packing Type	Kutu - Box
Adet / m	Quantity / m	10 m
Ağırlık	Weight	1,181 kg
m <sup>3</sup> /	Volume	0,00617

001 052 300001 00 00

45x45 Topraklı  
Priz Çekirdekleri 45°  
45x45 Earthed Socket Cores 45°



001 052 300002 00 00

45x45 UPS  
Priz Çekirdekleri 45°  
45x45 UPS Socket Cores 45°



001 052 200005 00 00

45x45 UPS ve Topraklı  
Priz Birleştirme Aparatı  
45 x 45 UPS and earthed socket  
connection apparatus



001 052 200003 00 00

45 x 45 UPS ve Topraklı  
Priz Birleştirme Aparatı  
(Yandan)  
45 x 45 UPS and earthed socket  
connection apparatus (Side)



001 050 030003 00 00

100x37/50  
Kanal Kilitleme Aparat  
Trunking Locking Apparatus



## İNGİLİZ NORMU PRİZ MONTAJ SETLERİ (100x50 İÇİN) BRITISH NORM PLUG SOCKET ASSEMBLY SETS (100x50)



### İngiliz Normu Tekli Priz Tabanı

British Norm Single  
Socket Base

Ürün Kodu	Product Code	001 047 980001 00 00
Ambalaj Şekli	Packing Type	Kutu - Box
Adet / m	Quantity / m	200 ad.
Ağırlık	Weight	3,850 kg
m <sup>3</sup> /	Volume	0,04000



### İngiliz Normu İkili Priz Tabanı

British Norm Double  
Socket Base

Ürün Kodu	Product Code	001 047 980002 00 00
Ambalaj Şekli	Packing Type	Kutu - Box
Adet / m	Quantity / m	100 ad.
Ağırlık	Weight	2,480 kg
m <sup>3</sup> /	Volume	0,04000

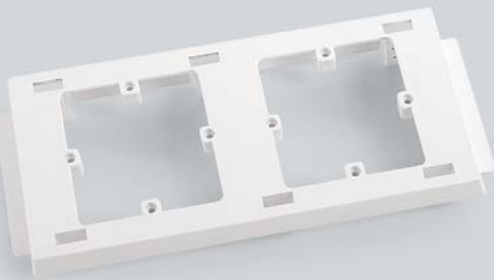

### İngiliz Normu İkili Yüksek Tip Priz Tabanı

British Norm  
Double High Type  
Socket Base

Ürün Kodu	Product Code	001 047 990002 00 00
Ambalaj Şekli	Packing Type	Kutu - Box
Adet / m	Quantity / m	94 ad.
Ağırlık	Weight	5,076 kg
m <sup>3</sup> /	Volume	0,03196



### Modüler Tip Kanal Üstü Montaj Çerçevesi

Modular System  
External Cover Socket  
Assembly Frame

Ürün Kodu	Product Code	001 047 950002 00 00
Ambalaj Şekli	Packing Type	Kutu - Box
Adet / m	Quantity / m	36 ad.
Ağırlık	Weight	1,116 kg
m <sup>3</sup> /	Volume	0,00636

**İNGİLİZ NORMU PRİZ MONTAJ SETLERİ (170x50 İÇİN)**  
**BRITISH NORM PLUG SOCKET ASSEMBLY SETS (170x50)**

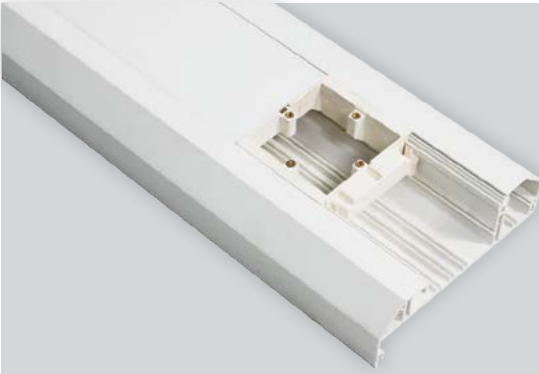

**İngiliz Normu  
Tekli Montaj Kasası**  
**British Norm  
Single Socket Base**

Ürün Kodu	Product Code	001 047 050001 00 00
Ambalaj Şekli	Packing Type	Kutu - Box
Adet / m	Quantity / m	138 ad.
Ağırlık	Weight	4,416 kg
m <sup>3</sup> /	Volume	0,03416



**İngiliz Normu  
İkili Montaj Kasası**  
**British Norm  
Double Socket Base**

Ürün Kodu	Product Code	001 047 050002 00 00
Ambalaj Şekli	Packing Type	Kutu - Box
Adet / m	Quantity / m	92 ad.
Ağırlık	Weight	4,784 kg
m <sup>3</sup> /	Volume	0,03416



**Sıvaaltı  
Anahtar Kasası  
(Kare Buat)**  
**Flush Mounted  
Switch Casing  
(Square Junction Box)**

Ürün Kodu	Product Code	001 166 000001 00 00
Ambalaj Şekli	Packing Type	Kutu - Box
Adet / m	Quantity / m	28 ad.
Ağırlık	Weight	1,176 kg
m <sup>3</sup> /	Volume	0,01120



Ürün Kodu	Product Code	001 002 050013 20 17
Ambalaj Şekli	Packing Type	Kutu - Box
Adet / m	Quantity / m	60 m
Ağırlık	Weight	23,400 kg
m <sup>3</sup> /	Volume	0,04000



Ürün Kodu	Product Code	001 002 060015 20 17
Ambalaj Şekli	Packing Type	Kutu - Box
Adet / m	Quantity / m	40 m
Ağırlık	Weight	14,572 kg
m <sup>3</sup> /	Volume	0,04000

**AKSESUARLAR - ACCESSORIES**

Kod Code	Ürün Product	Adet Quantity	Ağırlık Weight	m <sup>3</sup> Volume
001 041 060015 00 17	T Köşe T Corner	10	0,490 kg	0,00300
001 042 060015 00 17	L Köşe L Corner	24	0,495 kg	0,00240
001 043 060015 00 17	Ek Parça Connector	50	0,245 kg	0,00139
001 044 060015 00 17	Uç Tapa Blind Cap	50	0,240 kg	0,00139



Ürün Kodu	Product Code	001 002 075018 20 17
Ambalaj Şekli	Packing Type	Kutu - Box
Adet / m	Quantity / m	30 m
Ağırlık	Weight	19,239 kg
m <sup>3</sup> /	Volume	0,04000

**AKSESUARLAR - ACCESSORIES**

Kod Code	Ürün Product	Adet Quantity	Ağırlık Weight	m <sup>3</sup> Volume
001 041 075018 00 17	T Köşe T Corner	8	0,440 kg	0,00293
001 042 075018 00 17	L Köşe L Corner	15	0,400 kg	0,00293
001 043 075018 00 17	Ek Parça Connector	50	0,200 kg	0,00139
001 044 075018 00 17	Uç Tapa Blind Cap	50	0,270 kg	0,00139



Ürün Kodu	Product Code	001 002 090020 20 17
Ambalaj Şekli	Packing Type	Kutu - Box
Adet / m	Quantity / m	20 m
Ağırlık	Weight	16,580 kg
m <sup>3</sup> /	Volume	0,04000

**AKSESUARLAR - ACCESSORIES**

Kod Code	Ürün Product	Adet Quantity	Ağırlık Weight	m <sup>3</sup> Volume
001 041 090020 00 17	T Köşe T Corner	12	1,030 kg	0,00960
001 042 090020 00 17	L Köşe L Corner	20	0,765 kg	0,00600
001 043 090020 00 17	Ek Parça Connector	50	0,220 kg	0,00505
001 044 090020 00 17	Uç Tapa Blind Cap	50	0,310 kg	0,00244

# Klima Kanalı

## Air Conditioning Trunking

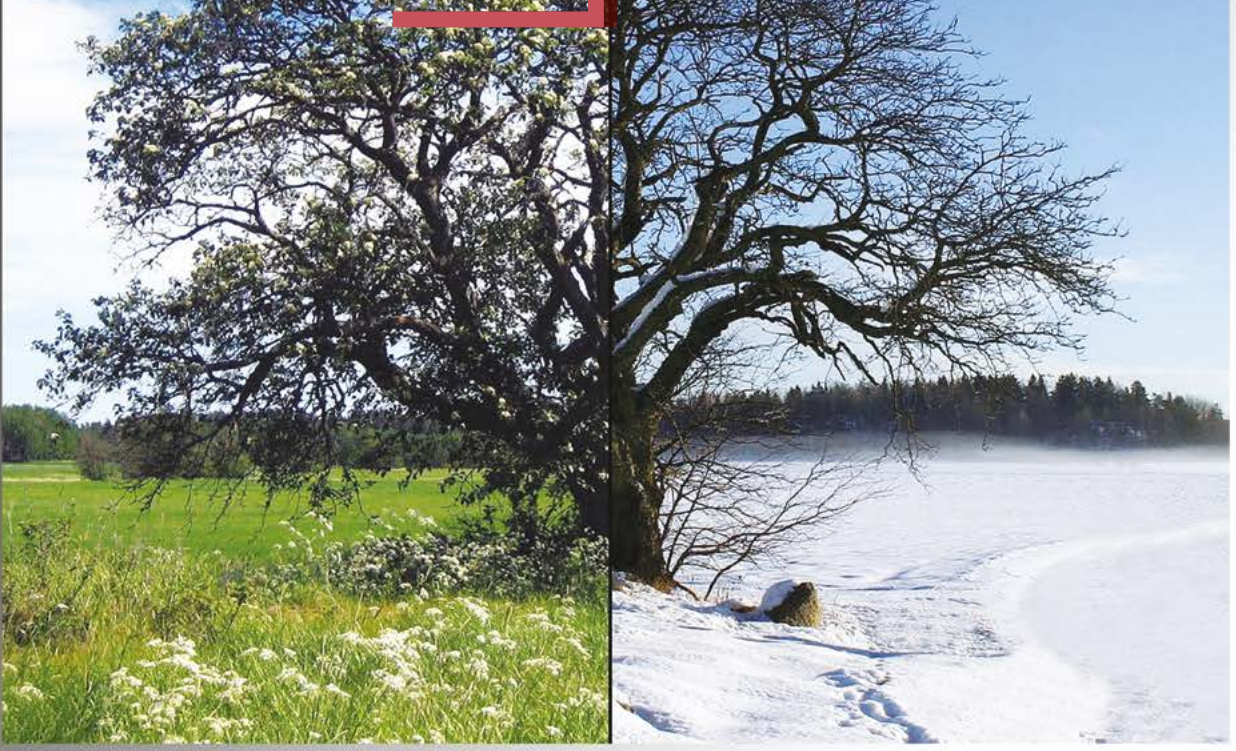

Dış Uç Tapa  
External Blind Cap

Ek Parça  
Connector

İç Köşe  
Internal Corner

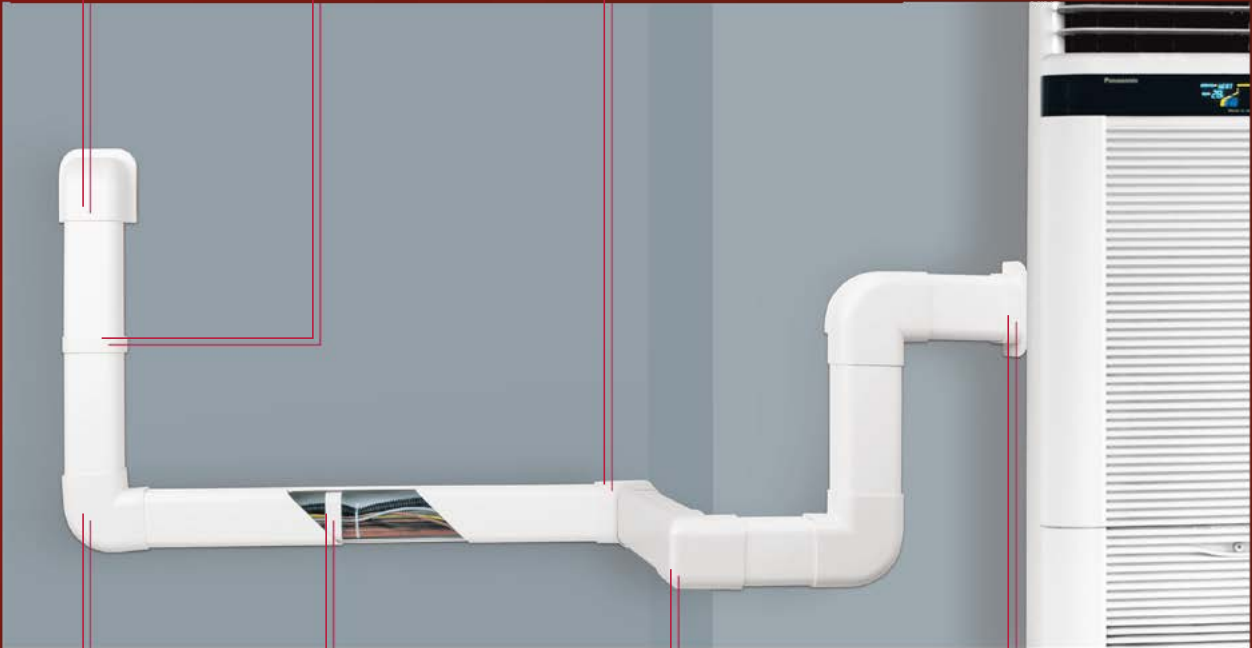

90° L Köşe  
90° L Corner

Kablo Tutucu  
Cable Holder

Dış Köşe  
External Corner

Duvar Geçisi  
Wall Penetration



**75x60**

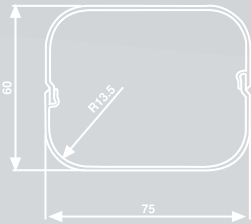

**MEKS** Serisi  
Series

Ürün Kodu	Product Code	001 002 075060 20 00
Ambalaj Şekli	Packing Type	Kutu - Box
Adet / m	Quantity / m	30 m
Ağırlık	Weight	18,643 kg
m <sup>3</sup> /	Volume	0,09272

**AKSESUARLAR - ACCESSORIES**

Kod Code	Ürün Product	Adet Quantity	Ağırlık Weight	m <sup>3</sup> Volume
 001 039 075060 00 00	İç Köşe Internal Corner	24	0,895 kg	0,01011
 001 040 075060 00 00	Dış Köşe External Corner	24	1,265 kg	0,01011
 001 042 075060 00 00	90° L Köşe 90° L Corner	18	1,115 kg	0,01011
 001 043 075060 00 00	Ek Parça Connector	40	0,380 kg	0,00293
 001 044 075060 00 00	İç Uç Tapa Internal Blind Cap	30	0,980 kg	0,01011
 001 044 075060 02 00	Dış Uç Tapa External Blind Cap	18	0,820 kg	0,01011
 001 050 030001 00 00	Duvar Geçişli Wall Penetration	60	0,905 kg	0,01011
 001 050 030002 00 00	Kablo Tutucu Cable Holder	60	0,460 kg	0,00293

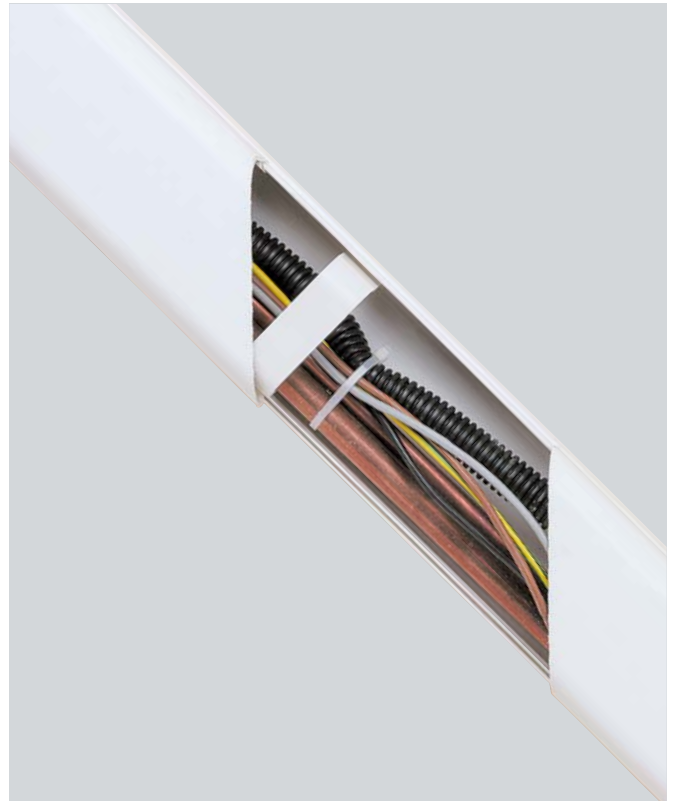

## Sidem serisi kablo kanalları

Sidem series cable  
trunking



Tüm ebatlardaki kablo kanallarımız ve aksesuarları bu bölümdeki renk seçenekleri ile boyanabilir özelliktedir.



The cable trunking and accessories of all sizes can be painted with the available color options presented in this chapter.



## RENK SEÇENEKLERİ COLOR OPTIONS

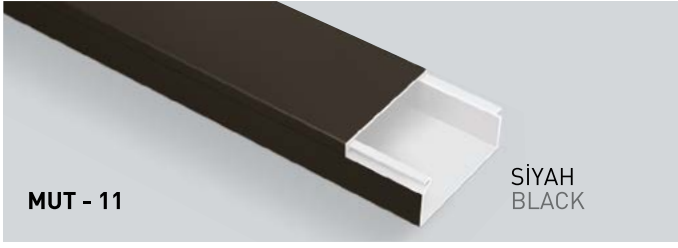

## AHŞAP RENK SEÇENEKLERİ WOOD COLOR OPTIONS

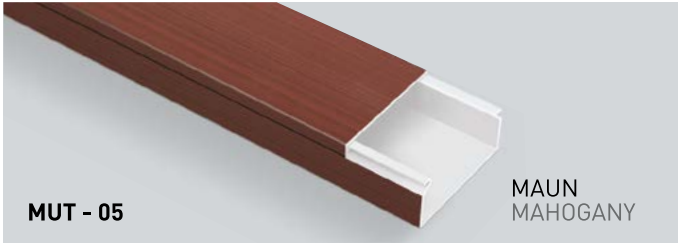
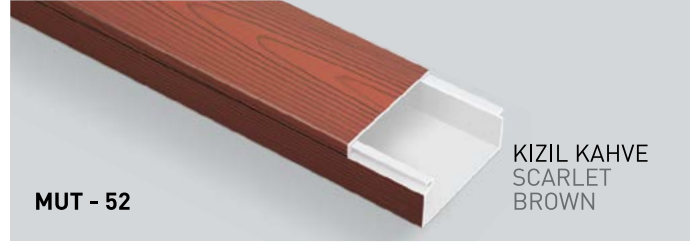
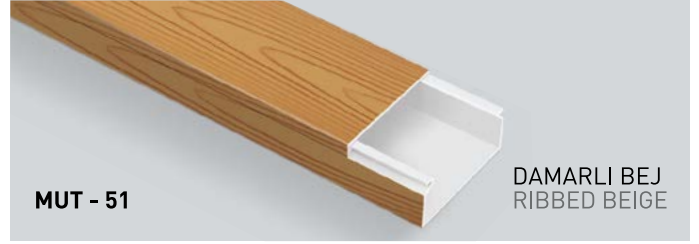

## AKSESUARLAR ACCESSORIES





# Promex

## DELİKLİ KABLO KANALLARI SLOTTED TRUNKING



Kanal tırnakları tabanın üst noktasından, herhangi bir el aletine gereksinim duymadan 90 derecelik bükülme sonucu kolayca kırılabilir.

Side ribs can be broken easily from the upper part of trunking without using any tool.



Özel tırnak tasarım yapısı ile kablolarınızı sıkıştırabilirsiniz. Kanal içindeki kabloların, kablo bağı ile bağlanmasına imkan veren delikleri sayesinde daha düzenli ve hızlı kablolama imkanına sahip olursunuz.

Especially designed ribs allow you to tight cables into trunking. You can make faster and stronger cabling through specially designed cable tie fixing slots.



Kanal yan duvarı, kolay kırılma çizgileri sayesinde tabana sıfır olarak çıkarılabilir.

Side wall can be removed easily from the bottom level scorline.

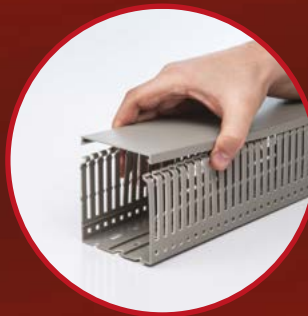

Özel kapak tasarımı, kanalın hangi konumda monte edildiğine bakılmaksızın kapağı kolayca monte etmemizi ve sökmemizi sağlar. Yoğun kablolamalarda bile kapağın kendinden çıkmasını engeller.

Strongly designed trunking cover allows you to assemble and disassemble it in any poistion of



Ultraviyole ışınlarına karşı dayanıklıdır.  
Resistance to UV light.



Tüm kanallarımız çift taraflı yapışkanlı bant ile kullanılabilir.  
Adhesive models are easy to install.



Asit buharına dayanıklıdır.  
Resistance to acidic vapor.

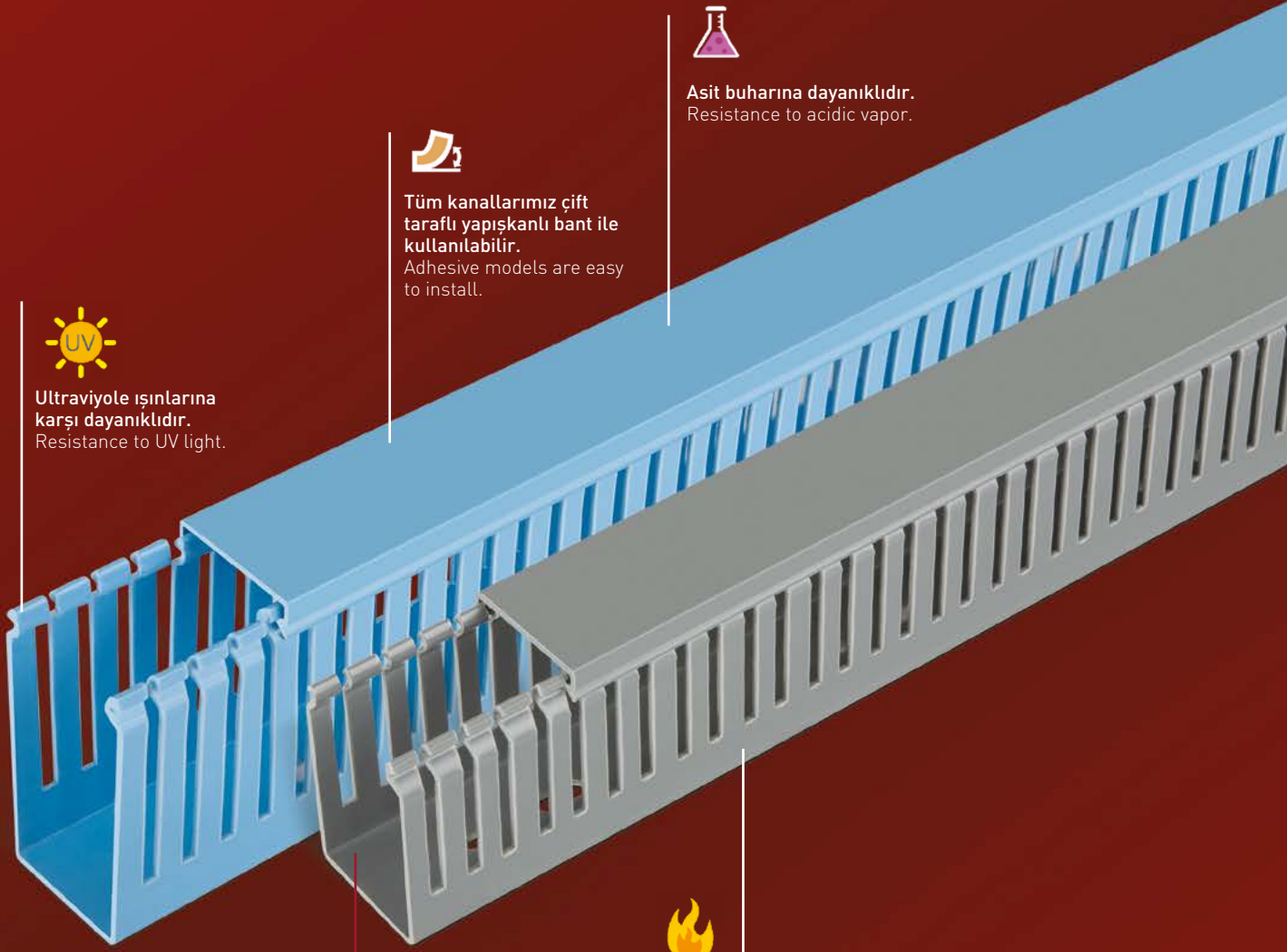

Aşırı soğuğa ve sicağa karşı dayanıklı.  
Resistant to extreme cold and heat.



Helogen Free  
Alev Yaymayan  
Nonflammable



Kolay yapışmayı sağlayan,  
Çift taraflı bant kullanılabilir.

Double sided adhesive  
Tape assuring easy fixation  
Can be used

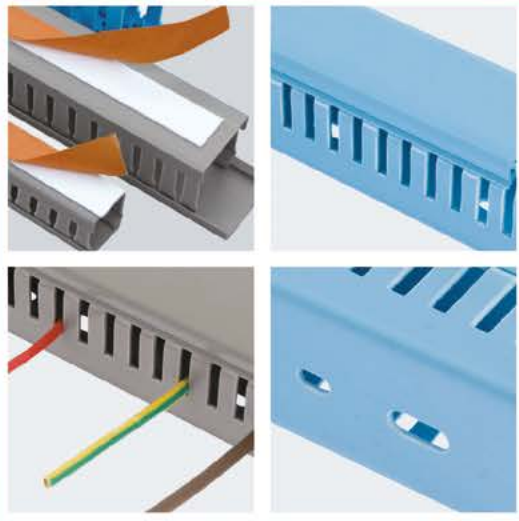

Kablo çıkışları için  
belirli aralıklar

Regular intervals for  
cable outlets

Düzenli aralıklarla  
montaj delikleri

Assembly holes with  
regular intervals

## PROMEX SERİSİ DELİKLİ KABLO KANALLARI

### PROMEX SERIES SLOTTED TRUNKING

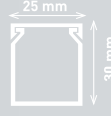
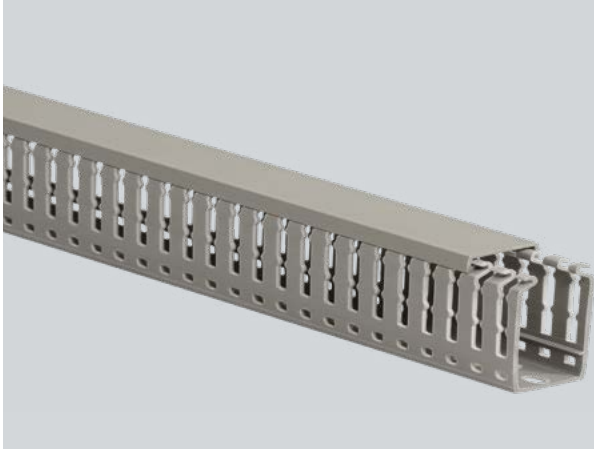

# 25x30

Gri  
Grey

Ürün Kodu	Product Code	001 105 025030 20 17
Ambalaj Şekli	Packing Type	Kutu - Box
Adet / m	Quantity / m	120 m
Slot Aralığı /mm	Slot Spacing (mm)	4/6/4
Ağırlık	Weight	29,4 kg
m <sup>3</sup>	Volume	0,0934

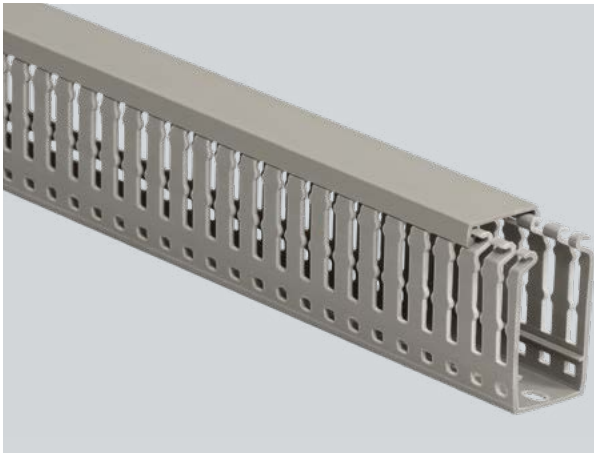

# 25x40

Gri  
Grey

Ürün Kodu	Product Code	001 105 025040 20 17
Ambalaj Şekli	Packing Type	Kutu - Box
Adet / m	Quantity / m	128 m
Slot Aralığı /mm	Slot Spacing (mm)	4/6/4
Ağırlık	Weight	36,352 kg
m <sup>3</sup>	Volume	0,1216

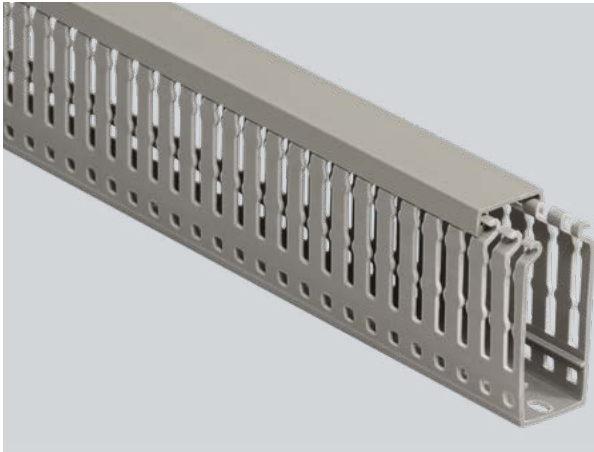

# 25x60

Gri  
Grey

Ürün Kodu	Product Code	001 105 025060 20 17
Ambalaj Şekli	Packing Type	Kutu - Box
Adet / m	Quantity / m	96 m
Slot Aralığı /mm	Slot Spacing (mm)	4/6/4
Ağırlık	Weight	33,504 kg
m <sup>3</sup>	Volume	0,1216

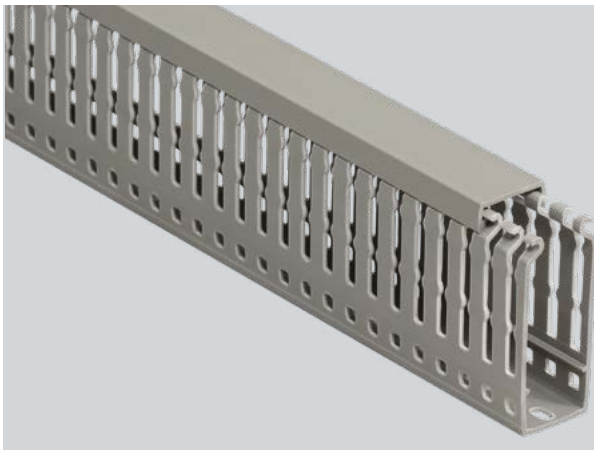

# 25x80

Gri  
Grey

Ürün Kodu	Product Code	001 105 025080 20 17
Ambalaj Şekli	Packing Type	Kutu - Box
Adet / m	Quantity / m	64 m
Slot Aralığı /mm	Slot Spacing (mm)	4/6/4
Ağırlık	Weight	26,752 kg
m <sup>3</sup>	Volume	0,1216

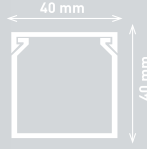
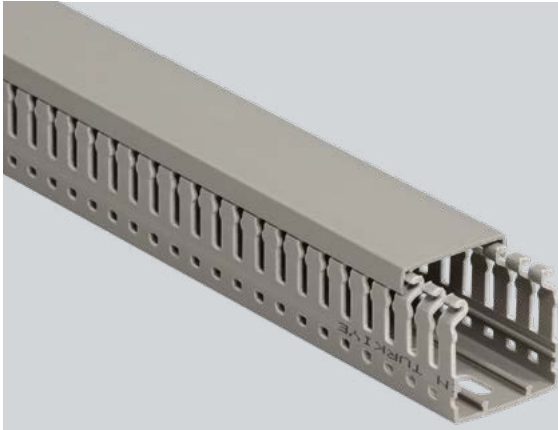
**PROMEX SERİSİ DELİKLİ KABLO KANALLARI**  
PROMEX SERIES SLOTTED TRUNKING**40x40**Gri  
Grey

Ürün Kodu	Product Code	001 105 040040 20 17
Ambalaj Şekli	Packing Type	Kutu - Box
Adet / m	Quantity / m	70 m
Slot Aralığı /mm	Slot Spacing (mm)	4/6/4
Ağırlık	Weight	26,32 kg
m <sup>3</sup>	Volume	0,1216

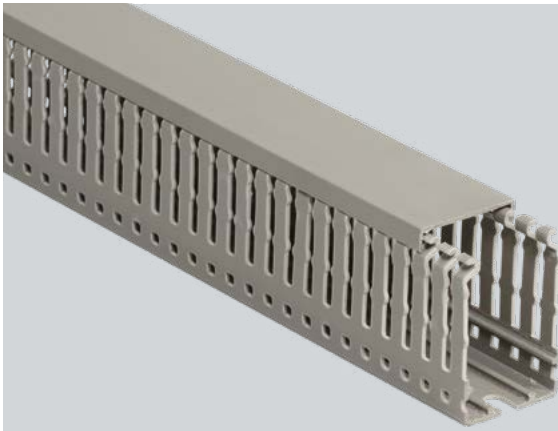
**40x60**Gri  
Grey

Ürün Kodu	Product Code	001 105 040060 20 17
Ambalaj Şekli	Packing Type	Kutu - Box
Adet / m	Quantity / m	60 m
Slot Aralığı /mm	Slot Spacing (mm)	4/6/4
Ağırlık	Weight	28,2 kg
m <sup>3</sup>	Volume	0,1216

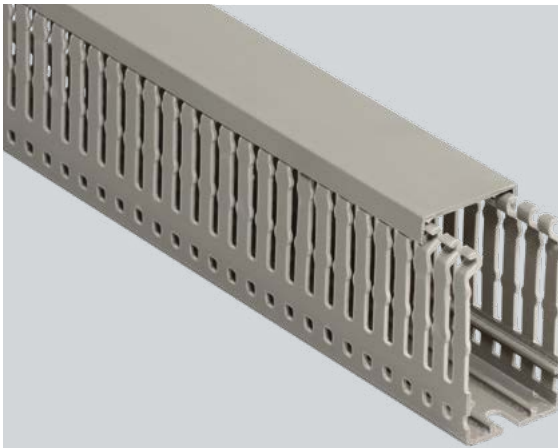
**40x80**Gri  
Grey

Ürün Kodu	Product Code	001 105 040080 20 17
Ambalaj Şekli	Packing Type	Kutu - Box
Adet / m	Quantity / m	40 m
Slot Aralığı /mm	Slot Spacing (mm)	4/6/4
Ağırlık	Weight	23,0 kg
m <sup>3</sup>	Volume	0,1216

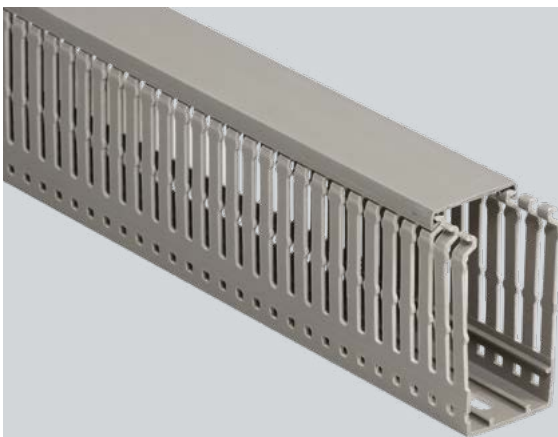
**40x100**Gri  
Grey

Ürün Kodu	Product Code	001 105 040100 20 17
Ambalaj Şekli	Packing Type	Kutu - Box
Adet / m	Quantity / m	40 m
Slot Aralığı /mm	Slot Spacing (mm)	5/8/5
Ağırlık	Weight	26,6 kg
m <sup>3</sup>	Volume	0,1216

## PROMEX SERİSİ DELİKLİ KABLO KANALLARI

### PROMEX SERIES SLOTTED TRUNKING

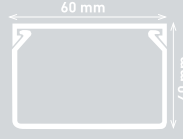
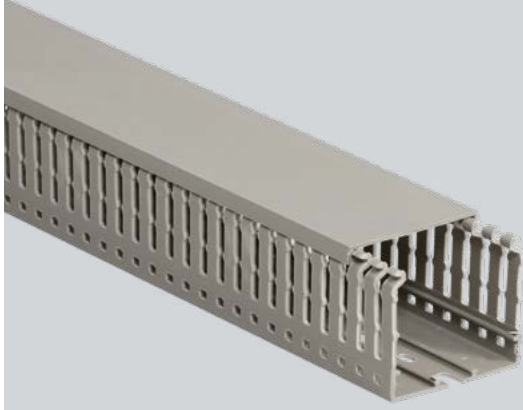

# 60x40

Gri  
Grey

Ürün Kodu	Product Code	001 105 040040 20 17
Ambalaj Şekli	Packing Type	Kutu - Box
Adet / m	Quantity / m	50 m
Slot Aralığı /mm	Slot Spacing (mm)	4/6/4
Ağırlık	Weight	24,8 kg
m <sup>3</sup>	Volume	0,1216 kg

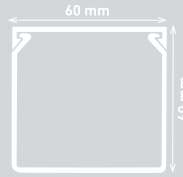
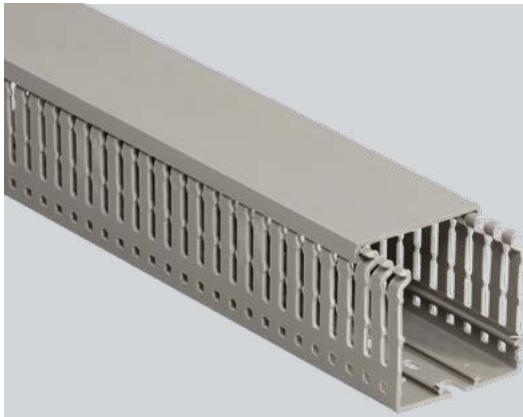

# 60x60

Gri  
Grey

Ürün Kodu	Product Code	001 105 060060 20 17
Ambalaj Şekli	Packing Type	Kutu - Box
Adet / m	Quantity / m	48 m
Slot Aralığı /mm	Slot Spacing (mm)	4/6/4
Ağırlık	Weight	29,18 kg
m <sup>3</sup>	Volume	0,1216

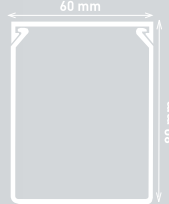
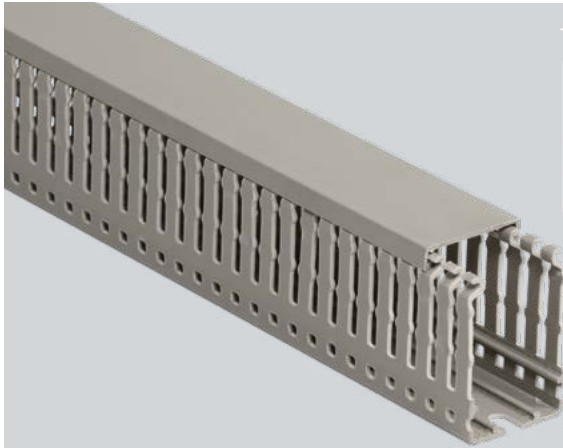

# 60x80

Gri  
Grey

Ürün Kodu	Product Code	001 105 060080 20 17
Ambalaj Şekli	Packing Type	Kutu - Box
Adet / m	Quantity / m	32 m
Slot Aralığı /mm	Slot Spacing (mm)	4/6/4
Ağırlık	Weight	22,91 kg
m <sup>3</sup>	Volume	0,1216

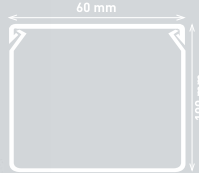
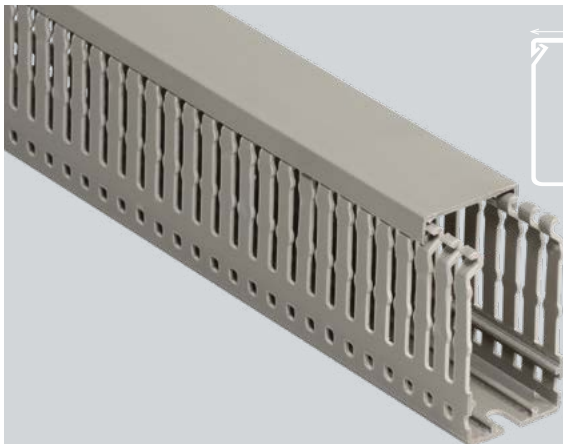

# 60x100

Gri  
Grey

Ürün Kodu	Product Code	001 105 060100 20 17
Ambalaj Şekli	Packing Type	Kutu - Box
Adet / m	Quantity / m	32 m
Slot Aralığı /mm	Slot Spacing (mm)	5/8/5
Ağırlık	Weight	25,47 kg
m <sup>3</sup>	Volume	0,1216

## PROMEX SERİSİ DELİKLİ KABLO KANALLARI

### PROMEX SERIES SLOTTED TRUNKING

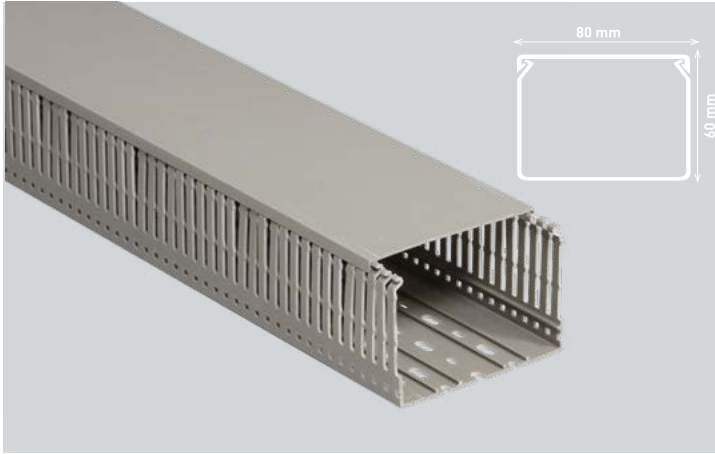
**80x60**Gri  
Grey

Ürün Kodu	Product Code	001 105 080060 20 17
Ambalaj Şekli	Packing Type	Kutu - Box
Adet / m	Quantity / m	25 m
Slot Aralığı /mm	Slot Spacing (mm)	4/6/4
Ağırlık	Weight	20,27 kg
m <sup>3</sup>	Volume	0,1216

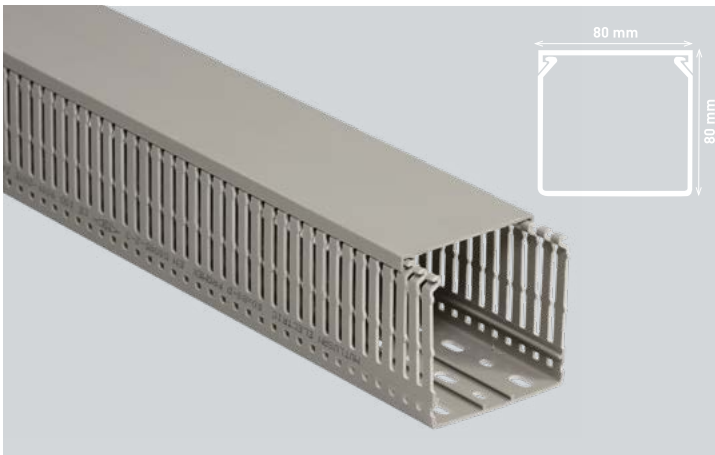
**80x80**Gri  
Grey

Ürün Kodu	Product Code	001 105 080080 20 17
Ambalaj Şekli	Packing Type	Kutu - Box
Adet / m	Quantity / m	24 m
Slot Aralığı /mm	Slot Spacing (mm)	4/6/4
Ağırlık	Weight	19,8 kg
m <sup>3</sup>	Volume	0,1216

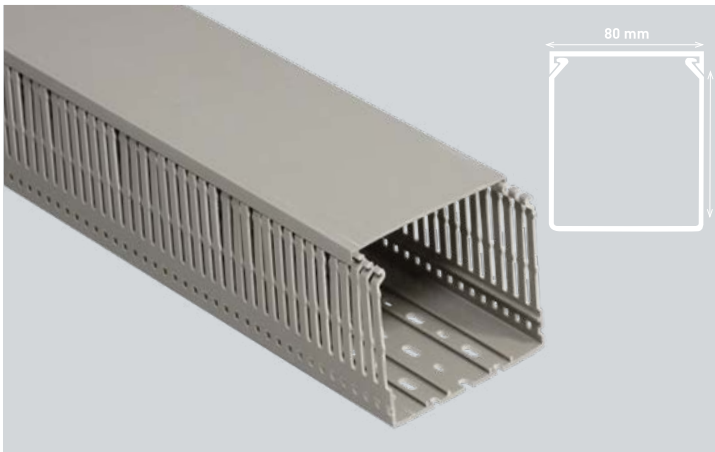
**80x100**Gri  
Grey

Ürün Kodu	Product Code	001 105 080100 20 17
Ambalaj Şekli	Packing Type	Kutu - Box
Adet / m	Quantity / m	24 m
Slot Aralığı /mm	Slot Spacing (mm)	5/8/5
Ağırlık	Weight	22,68 kg
m <sup>3</sup>	Volume	0,1216

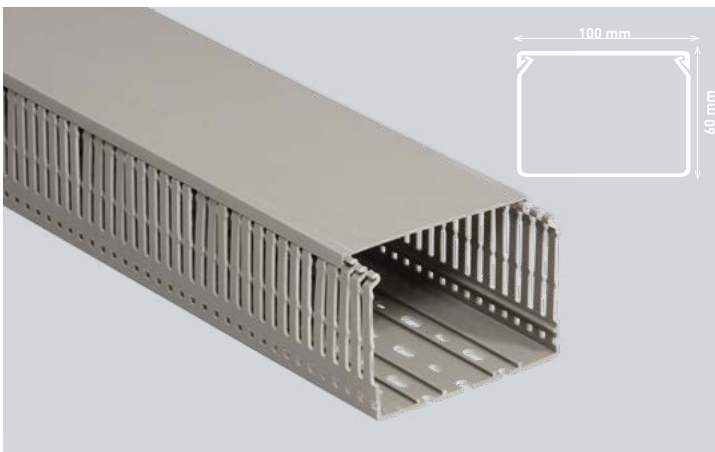
**100x60**Gri  
Grey

Ürün Kodu	Product Code	001 105 100060 20 17
Ambalaj Şekli	Packing Type	Kutu - Box
Adet / m	Quantity / m	20 m
Slot Aralığı /mm	Slot Spacing (mm)	4/6/4
Ağırlık	Weight	18,0 kg
m <sup>3</sup>	Volume	0,1216

## PROMEX SERİSİ DELİKLİ KABLO KANALLARI

### PROMEX SERIES SLOTTED TRUNKING

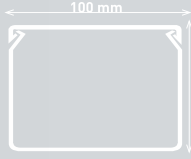

**100x80**

Gri  
Grey

Ürün Kodu	Product Code	001 105 100080 20 17
Ambalaj Şekli	Packing Type	Kutu - Box
Adet / m	Quantity / m	20 m
Slot Aralığı /mm	Slot Spacing (mm)	4/6/4
Ağırlık	Weight	20,4 kg
m <sup>3</sup>	Volume	0,1216

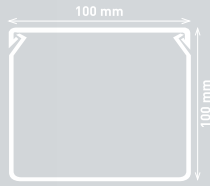
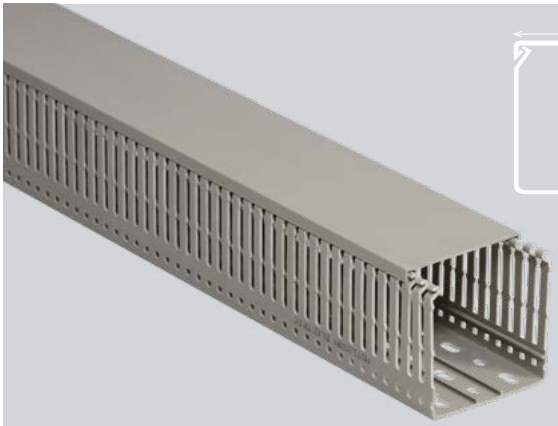

**100x100**

Gri  
Grey

Ürün Kodu	Product Code	001 105 100100 20 17
Ambalaj Şekli	Packing Type	Kutu - Box
Adet / m	Quantity / m	16 m
Slot Aralığı /mm	Slot Spacing (mm)	5/8/5
Ağırlık	Weight	17,49 kg
m <sup>3</sup>	Volume	0,1216



**120x60**

Gri  
Grey

Ürün Kodu	Product Code	001 105 120060 20 17
Ambalaj Şekli	Packing Type	Kutu - Box
Adet / m	Quantity / m	20 m
Slot Aralığı /mm	Slot Spacing (mm)	4/6/4
Ağırlık	Weight	20,8 kg
m <sup>3</sup>	Volume	0,1216

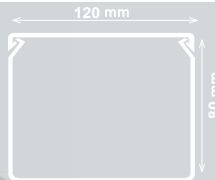
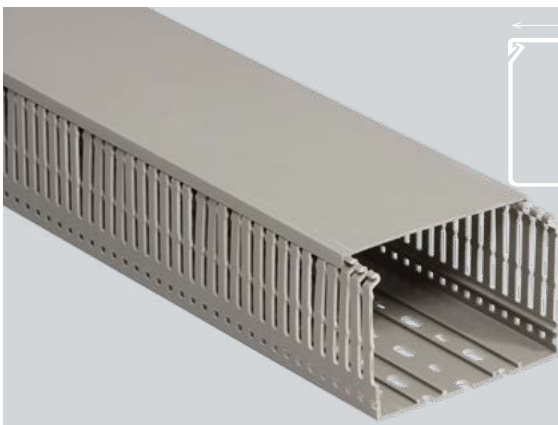

**120x80**

Gri  
Grey

Ürün Kodu	Product Code	001 105 120080 20 17
Ambalaj Şekli	Packing Type	Kutu - Box
Adet / m	Quantity / m	16 m
Slot Aralığı /mm	Slot Spacing (mm)	4/6/4
Ağırlık	Weight	17,49 kg
m <sup>3</sup>	Volume	0,1216

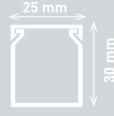
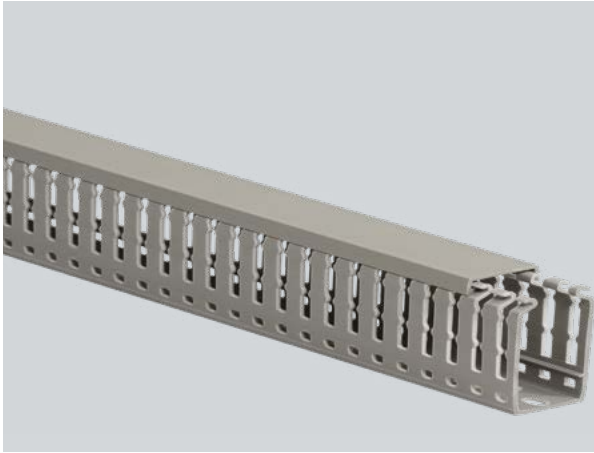

**FLARET HALOJEN FREE DELİKLİ KABLO KANALLARI**  
FLARET HALOGEN FREE SLOTTED TRUNKING**25x30**Gri  
Grey

Ürün Kodu	Product Code	001 065 025030 20 17
Ambalaj Şekli	Packing Type	Kutu - Box
Adet / m	Quantity / m	120 m
Slot Aralığı /mm	Slot Spacing (mm)	4/6/4
m <sup>3</sup>	Volume	0,0934

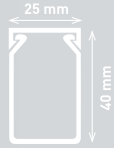
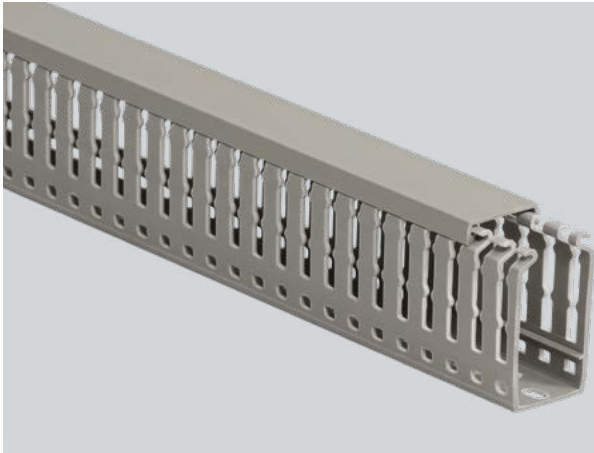
**25x40**Gri  
Grey

Ürün Kodu	Product Code	001 065 025040 20 17
Ambalaj Şekli	Packing Type	Kutu - Box
Adet / m	Quantity / m	128 m
Slot Aralığı /mm	Slot Spacing (mm)	4/6/4
m <sup>3</sup>	Volume	0,1216

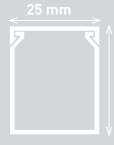
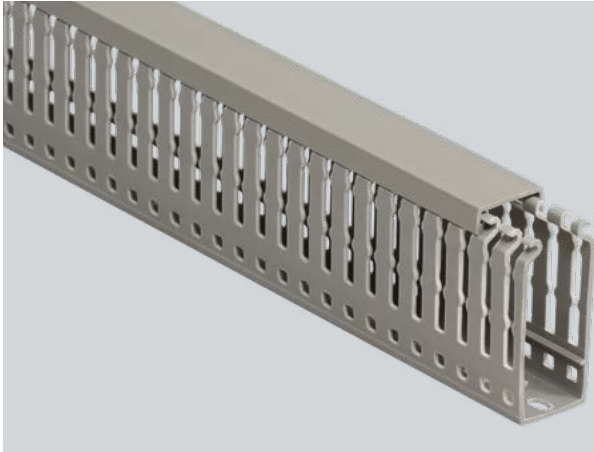
**25x60**Gri  
Grey

Ürün Kodu	Product Code	001 065 025060 20 17
Ambalaj Şekli	Packing Type	Kutu - Box
Adet / m	Quantity / m	96 m
Slot Aralığı /mm	Slot Spacing (mm)	4/6/4
m <sup>3</sup>	Volume	0,1216

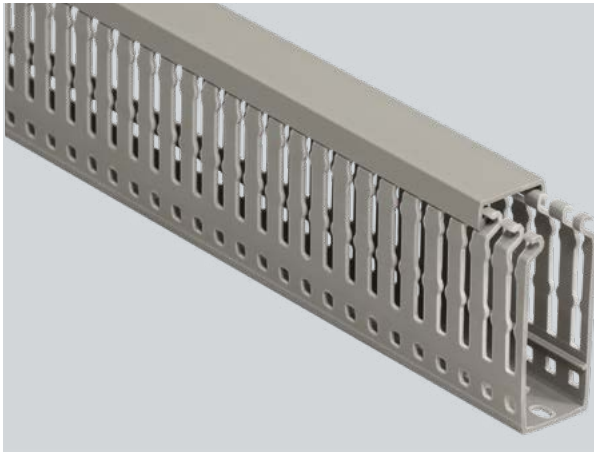
**25x80**Gri  
Grey

Ürün Kodu	Product Code	001 065 025080 20 17
Ambalaj Şekli	Packing Type	Kutu - Box
Adet / m	Quantity / m	64 m
Slot Aralığı /mm	Slot Spacing (mm)	4/6/4
m <sup>3</sup>	Volume	0,1216

## FLARET HALOJEN FREE DELİKLİ KABLO KANALLARI FLARET HALOGEN FREE SLOTTED TRUNKING

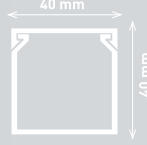
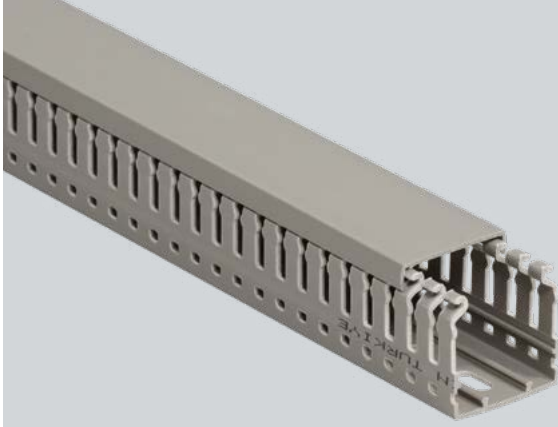

### 40x40

Gri  
Grey

Ürün Kodu	Product Code	001 065 040040 20 17
Ambalaj Şekli	Packing Type	Kutu - Box
Adet / m	Quantity / m	70 m
Slot Aralığı /mm	Slot Spacing (mm)	4/6/4
m <sup>3</sup>	Volume	0,1216

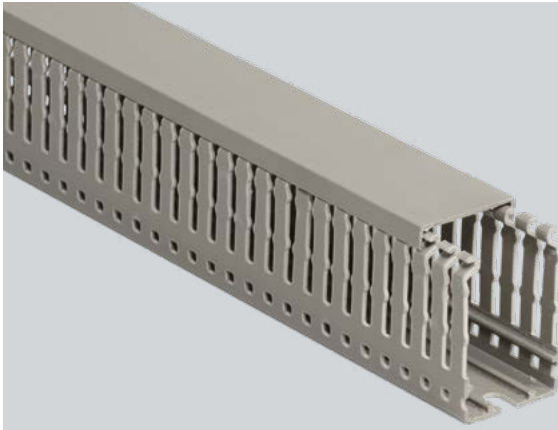

### 40x60

Gri  
Grey

Ürün Kodu	Product Code	001 065 040060 20 17
Ambalaj Şekli	Packing Type	Kutu - Box
Adet / m	Quantity / m	60 m
Slot Aralığı /mm	Slot Spacing (mm)	4/6/4
m <sup>3</sup>	Volume	0,1216

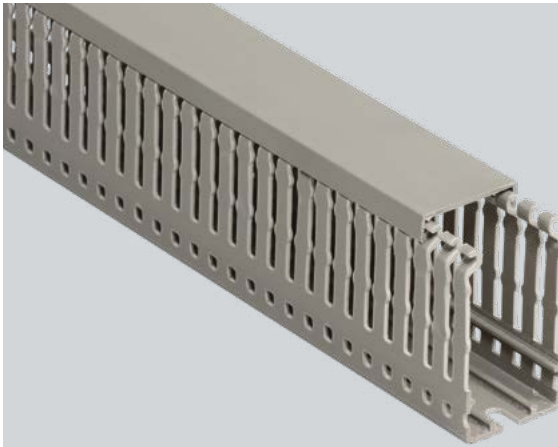

### 40x80

Gri  
Grey

Ürün Kodu	Product Code	001 065 040080 20 17
Ambalaj Şekli	Packing Type	Kutu - Box
Adet / m	Quantity / m	40 m
Slot Aralığı /mm	Slot Spacing (mm)	4/6/4
m <sup>3</sup>	Volume	0,1216

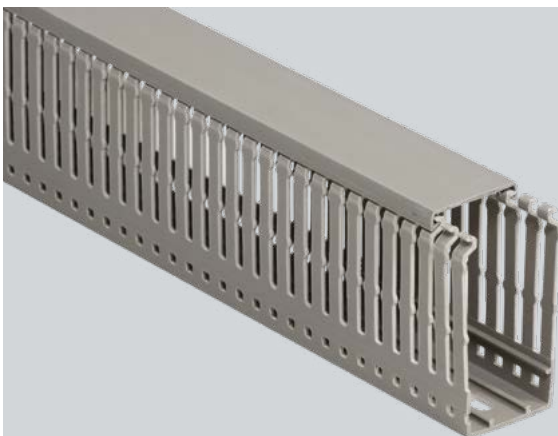

### 40x100

Gri  
Grey

Ürün Kodu	Product Code	001 065 040100 20 17
Ambalaj Şekli	Packing Type	Kutu - Box
Adet / m	Quantity / m	40 m
Slot Aralığı /mm	Slot Spacing (mm)	5/8/5
m <sup>3</sup>	Volume	0,1216

## FLARET HALOJEN FREE DELİKLİ KABLO KANALLARI

### FLARET HALOGEN FREE SLOTTED TRUNKING

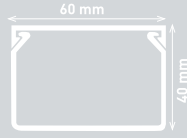
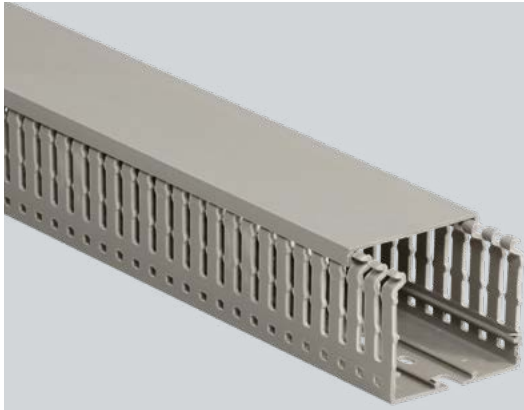

# 60x40

Gri  
Grey

Ürün Kodu	Product Code	001 065 060040 20 17
Ambalaj Şekli	Packing Type	Kutu - Box
Adet / m	Quantity / m	50 m
Slot Aralığı /mm	Slot Spacing (mm)	4/6/4
m <sup>3</sup>	Volume	0,1216 kg

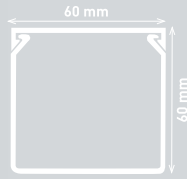
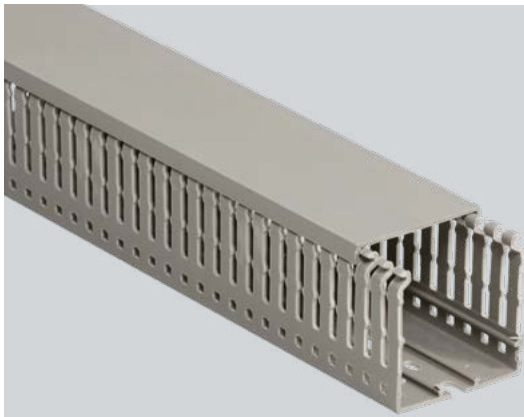

# 60x60

Gri  
Grey

Ürün Kodu	Product Code	001 065 060060 20 17
Ambalaj Şekli	Packing Type	Kutu - Box
Adet / m	Quantity / m	48 m
Slot Aralığı /mm	Slot Spacing (mm)	4/6/4
m <sup>3</sup>	Volume	0,1216

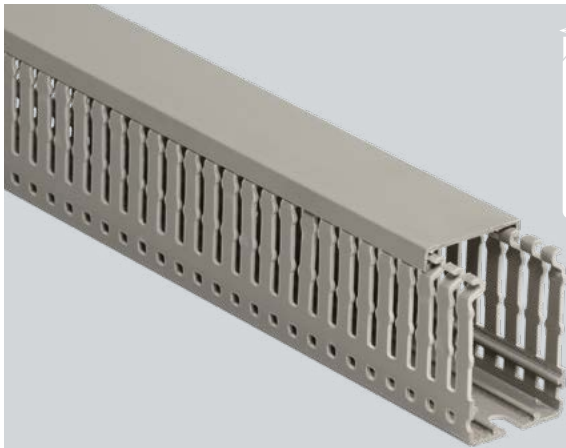

# 60x80

Gri  
Grey

Ürün Kodu	Product Code	001 065 060080 20 17
Ambalaj Şekli	Packing Type	Kutu - Box
Adet / m	Quantity / m	32 m
Slot Aralığı /mm	Slot Spacing (mm)	4/6/4
m <sup>3</sup>	Volume	0,1216

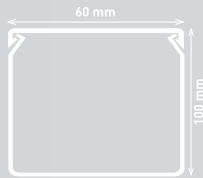
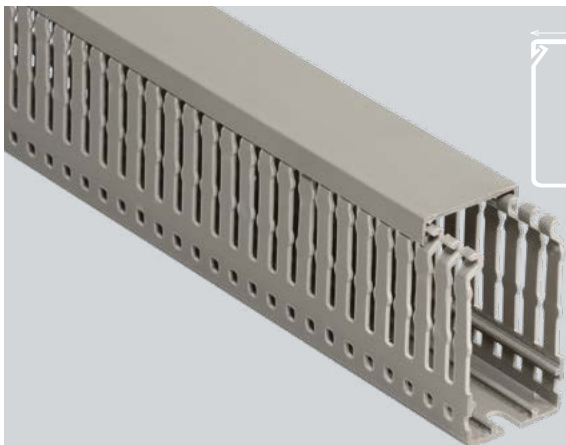

# 60x100

Gri  
Grey

Ürün Kodu	Product Code	001 065 060100 20 17
Ambalaj Şekli	Packing Type	Kutu - Box
Adet / m	Quantity / m	32 m
Slot Aralığı /mm	Slot Spacing (mm)	5/8/5
m <sup>3</sup>	Volume	0,1216

## FLARET HALOJEN FREE DELİKLİ KABLO KANALLARI FLARET HALOGEN FREE SLOTTED TRUNKING

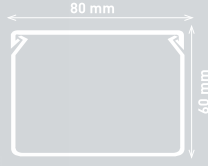

### 80x60

Gri  
Grey

Ürün Kodu	Product Code	001 065 080060 20 17
Ambalaj Şekli	Packing Type	Kutu - Box
Adet / m	Quantity / m	25 m
Slot Aralığı /mm	Slot Spacing (mm)	4/6/4
m <sup>3</sup>	Volume	0,1216

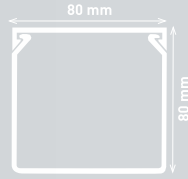
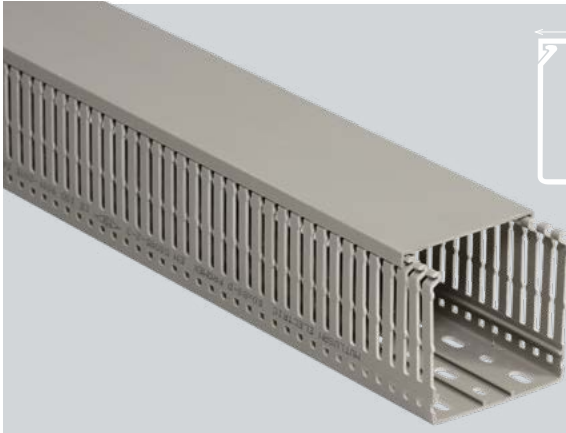

### 80x80

Gri  
Grey

Ürün Kodu	Product Code	001 065 080080 20 17
Ambalaj Şekli	Packing Type	Kutu - Box
Adet / m	Quantity / m	24 m
Slot Aralığı /mm	Slot Spacing (mm)	4/6/4
m <sup>3</sup>	Volume	0,1216

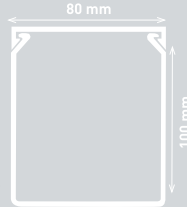

### 80x100

Gri  
Grey

Ürün Kodu	Product Code	001 065 080100 20 17
Ambalaj Şekli	Packing Type	Kutu - Box
Adet / m	Quantity / m	24 m
Slot Aralığı /mm	Slot Spacing (mm)	5/8/5
m <sup>3</sup>	Volume	0,1216

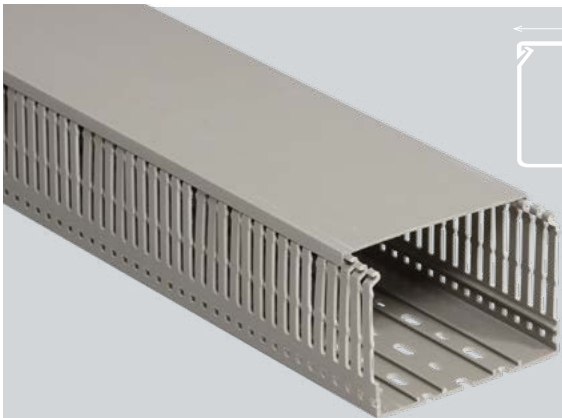

### 100x60

Gri  
Grey

Ürün Kodu	Product Code	001 065 100060 20 17
Ambalaj Şekli	Packing Type	Kutu - Box
Adet / m	Quantity / m	20 m
Slot Aralığı /mm	Slot Spacing (mm)	4/6/4
m <sup>3</sup>	Volume	0,1216

## FLARET HALOJEN FREE DELİKLİ KABLO KANALLARI

### FLARET HALOGEN FREE SLOTTED TRUNKING

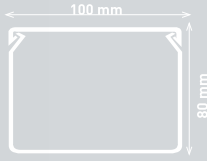
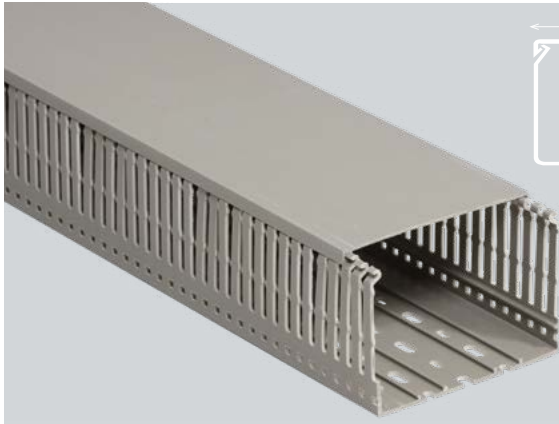

# 100x80

Gri  
Grey

Ürün Kodu	Product Code	001 065 100080 20 17
Ambalaj Şekli	Packing Type	Kutu - Box
Adet / m	Quantity / m	20 m
Slot Aralığı /mm	Slot Spacing (mm)	4/6/4
m <sup>3</sup>	Volume	0,1216

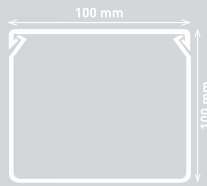
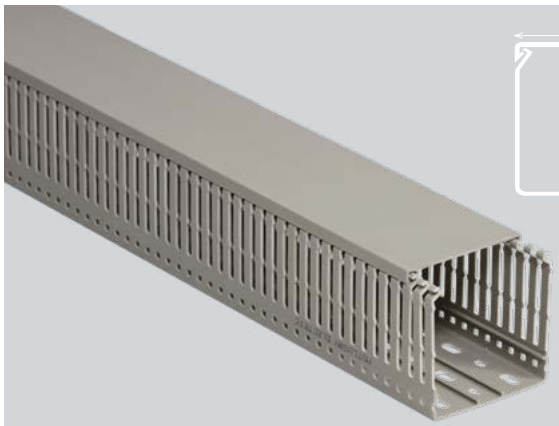

# 100x100

Gri  
Grey

Ürün Kodu	Product Code	001 065 100100 20 17
Ambalaj Şekli	Packing Type	Kutu - Box
Adet / m	Quantity / m	16 m
Slot Aralığı /mm	Slot Spacing (mm)	5/8/5
m <sup>3</sup>	Volume	0,1216

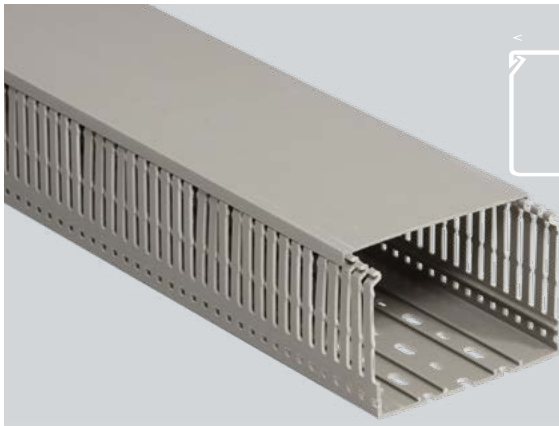

# 120x60

Gri  
Grey

Ürün Kodu	Product Code	001 065 120060 20 17
Ambalaj Şekli	Packing Type	Kutu - Box
Adet / m	Quantity / m	20 m
Slot Aralığı /mm	Slot Spacing (mm)	4/6/4
m <sup>3</sup>	Volume	0,1216

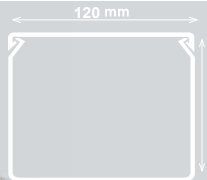
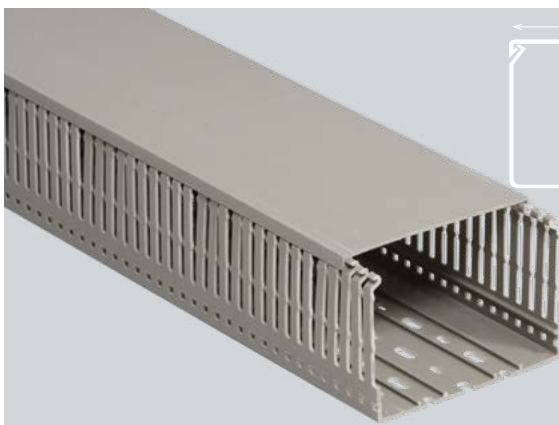

# 120x80

Gri  
Grey

Ürün Kodu	Product Code	001 065 120080 20 17
Ambalaj Şekli	Packing Type	Kutu - Box
Adet / m	Quantity / m	16 m
Slot Aralığı /mm	Slot Spacing (mm)	4/6/4
m <sup>3</sup>	Volume	0,1216

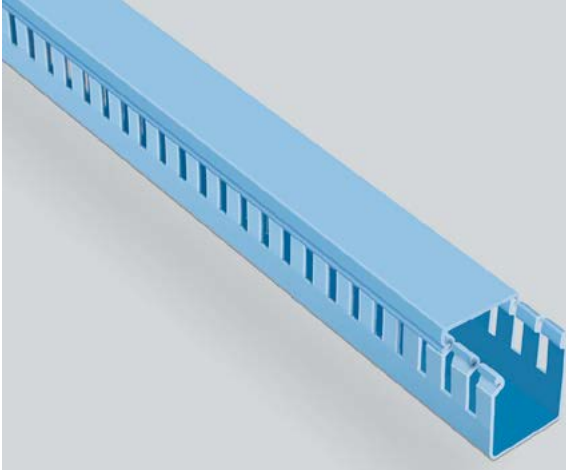
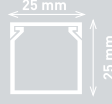

**MEKS SERİSİ DELİKLİ KABLO KANALLARI**  
MEKS SERIES SLOTTED TRUNKING**25x25****Mavi**  
Blue

Ürün Kodu	Product Code	001 005 025025 20 13
Ambalaj Şekli	Packing Type	Kutu - Box
Adet / m	Quantity / m	120 m
Ağırlık	Weight	20,465 kg
m <sup>3</sup> /	Volume	0,09272

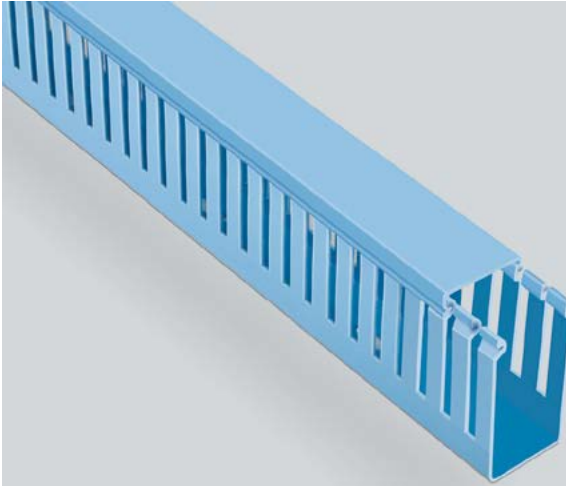
**25x40****Mavi**  
Blue

Ürün Kodu	Product Code	001 005 025040 20 13
Ambalaj Şekli	Packing Type	Kutu - Box
Adet / m	Quantity / m	80 m
Ağırlık	Weight	18,865 kg
m <sup>3</sup> /	Volume	0,09272

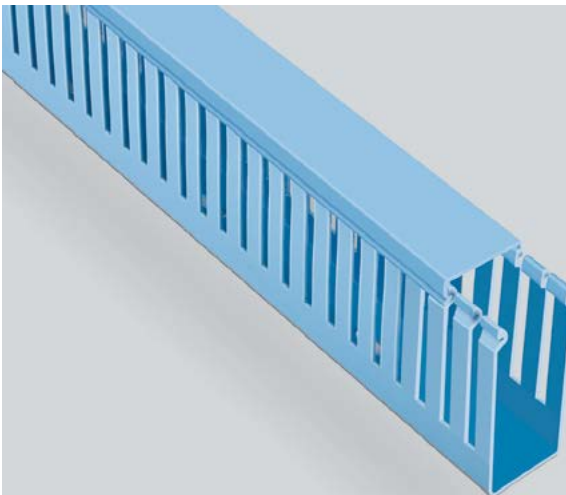
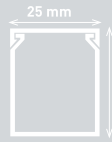
**25x60****Mavi**  
Blue

Ürün Kodu	Product Code	001 005 025060 20 13
Ambalaj Şekli	Packing Type	Kutu - Box
Adet / m	Quantity / m	80 m
Ağırlık	Weight	32,960 kg
m <sup>3</sup> /	Volume	0,13392

## MEKS SERİSİ DELİKLİ KABLO KANALLARI

### MEKS SERIES SLOTTED TRUNKING

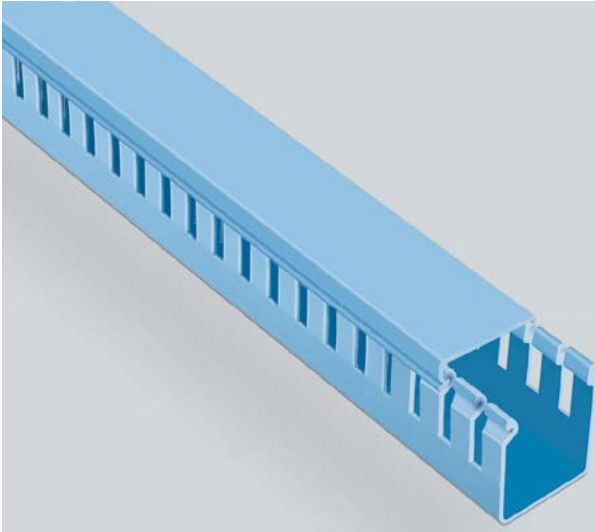

**40x40**

**Mavi**  
Blue

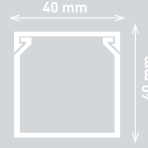

Ürün Kodu	Product Code	001 005 040040 20 13
Ambalaj Şekli	Packing Type	Kutu - Box
Adet / m	Quantity / m	50 m
Ağırlık	Weight	15,375 kg
m <sup>3</sup> /	Volume	0,09272

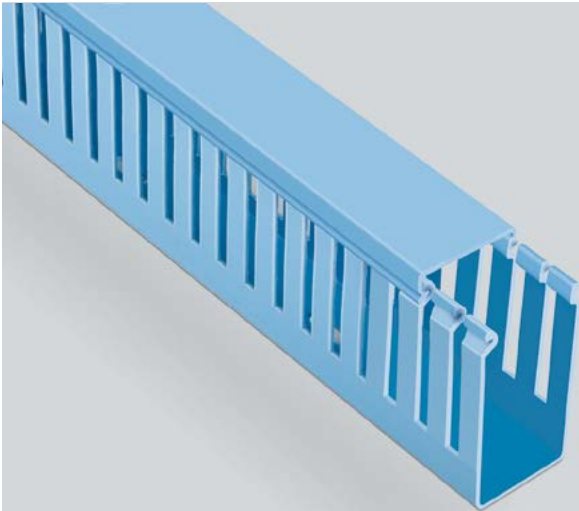

**40x60**

**Mavi**  
Blue

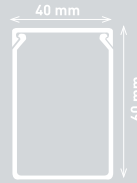

Ürün Kodu	Product Code	001 005 040060 20 13
Ambalaj Şekli	Packing Type	Kutu - Box
Adet / m	Quantity / m	48 m
Ağırlık	Weight	19,680 kg
m <sup>3</sup> /	Volume	0,11029

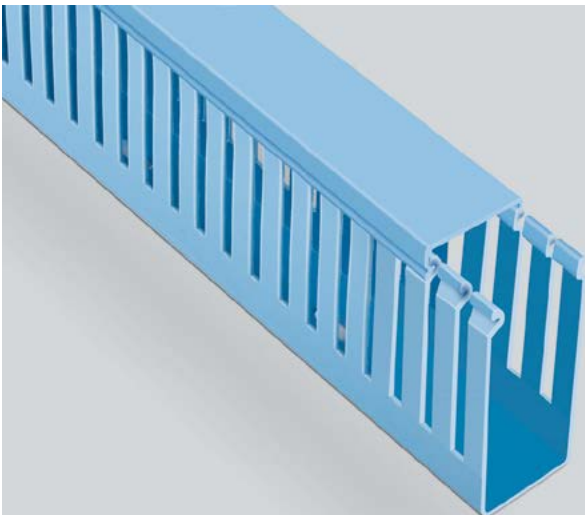

**40x80**

**Mavi**  
Blue

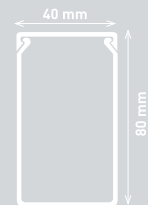

Ürün Kodu	Product Code	001 005 040080 20 13
Ambalaj Şekli	Packing Type	Kutu - Box
Adet / m	Quantity / m	36 m
Ağırlık	Weight	21,706 kg
m <sup>3</sup> /	Volume	0,11029

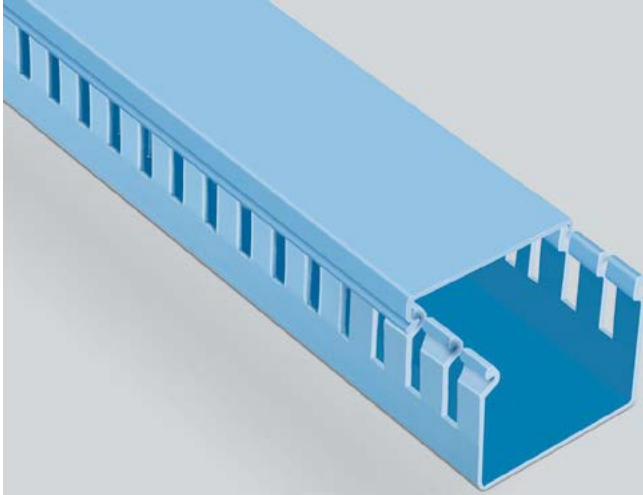
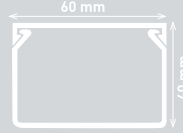

**MEKS SERİSİ DELİKLİ KABLO KANALLARI**  
MEKS SERIES SLOTTED TRUNKING**60x40****Mavi**  
Blue

Ürün Kodu	Product Code	001 005 060040 20 13
Ambalaj Şekli	Packing Type	Kutu - Box
Adet / m	Quantity / m	48 m
Ağırlık	Weight	21,670 kg
m <sup>3</sup> /	Volume	0,13392

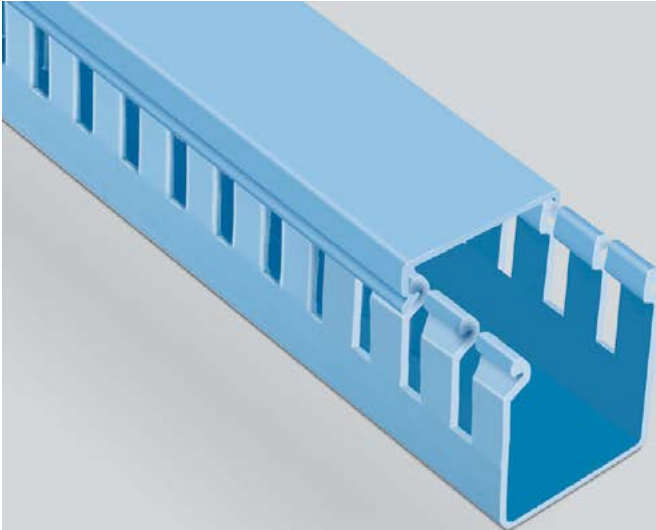
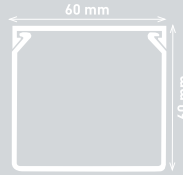
**60x60****Mavi**  
Blue

Ürün Kodu	Product Code	001 005 060060 20 13
Ambalaj Şekli	Packing Type	Kutu - Box
Adet / m	Quantity / m	32 m
Ağırlık	Weight	17,440 kg
m <sup>3</sup> /	Volume	0,13392

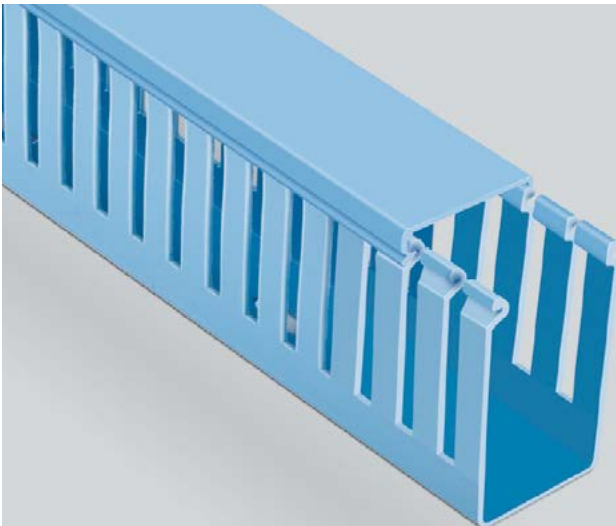
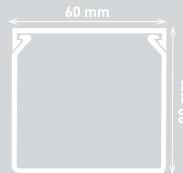
**60x80****Mavi**  
Blue

Ürün Kodu	Product Code	001 005 060080 20 13
Ambalaj Şekli	Packing Type	Kutu - Box
Adet / m	Quantity / m	24 m
Ağırlık	Weight	15,120 kg
m <sup>3</sup> /	Volume	0,13392

## MEKS SERİSİ DELİKLİ KABLO KANALLARI

### MEKS SERIES SLOTTED TRUNKING

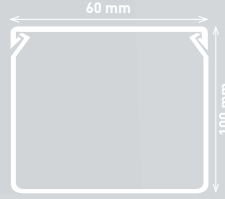
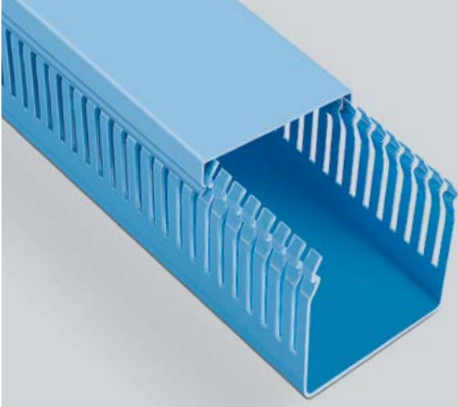

**60x100**

**Mavi**  
Blue

Ürün Kodu	Product Code	001 005 060100 20 13
Ambalaj Şekli	Packing Type	Kutu - Box
Adet / m	Quantity / m	16 m
Ağırlık	Weight	11,680 kg
m <sup>3</sup> /	Volume	0,11029

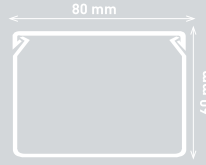
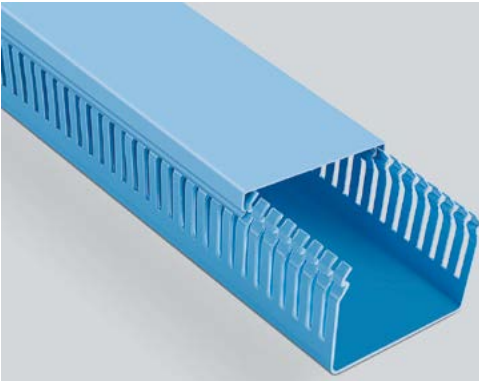

**80x60**

**Mavi**  
Blue

Ürün Kodu	Product Code	001 005 080060 20 13
Ambalaj Şekli	Packing Type	Kutu - Box
Adet / m	Quantity / m	24 m
Ağırlık	Weight	16,030 kg
m <sup>3</sup> /	Volume	0,13392

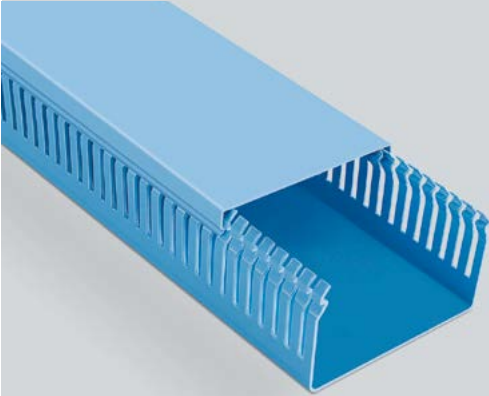

**100x60**

**Mavi**  
Blue

Ürün Kodu	Product Code	001 005 100060 20 13
Ambalaj Şekli	Packing Type	Kutu - Box
Adet / m	Quantity / m	16 m
Ağırlık	Weight	13,590 kg
m <sup>3</sup> /	Volume	0,11029

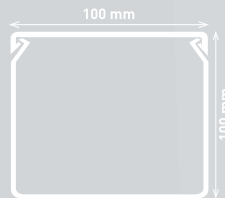
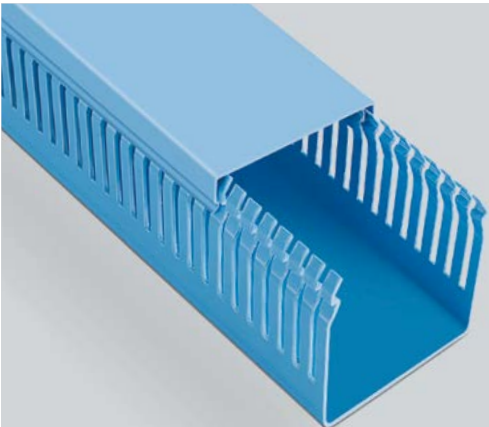

**100x100**

**Mavi**  
Blue

Ürün Kodu	Product Code	001 005 100100 20 13
Ambalaj Şekli	Packing Type	Kutu - Box
Adet / m	Quantity / m	8 m
Ağırlık	Weight	10,622 kg
m <sup>3</sup> /	Volume	0,11029

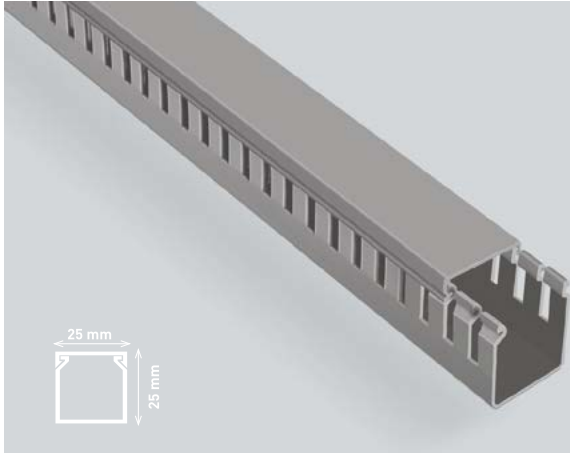
**MEKS SERİSİ DELİKLİ KABLO KANALLARI**  
MEKS SERIES SLOTTED TRUNKING**25x25****Gri**  
Grey

Ürün Kodu	Product Code	001 005 025025 20 17
Ambalaj Şekli	Packing Type	Kutu - Box
Adet / m	Quantity / m	120 m
Ağırlık	Weight	20,465 kg
m <sup>3</sup> /	Volume	0,09272

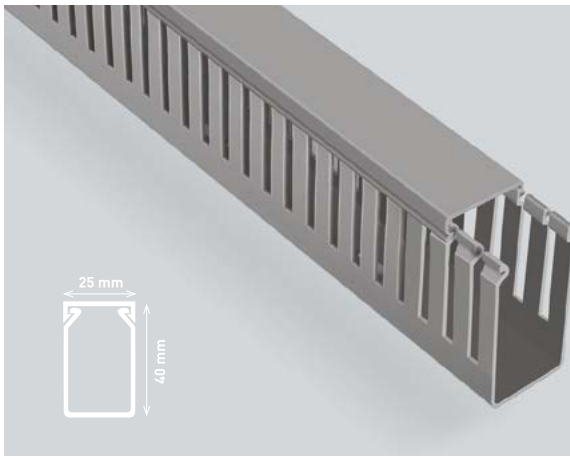
**25x40****Gri**  
Grey

Ürün Kodu	Product Code	001 005 025040 20 17
Ambalaj Şekli	Packing Type	Kutu - Box
Adet / m	Quantity / m	80 m
Ağırlık	Weight	18,864 kg
m <sup>3</sup> /	Volume	0,09272

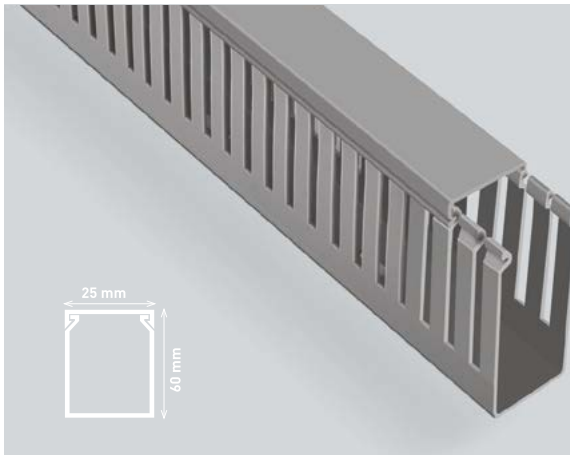
**25x60****Gri**  
Grey

Ürün Kodu	Product Code	001 005 025060 20 17
Ambalaj Şekli	Packing Type	Kutu - Box
Adet / m	Quantity / m	80 m
Ağırlık	Weight	32,960 kg
m <sup>3</sup> /	Volume	0,13392

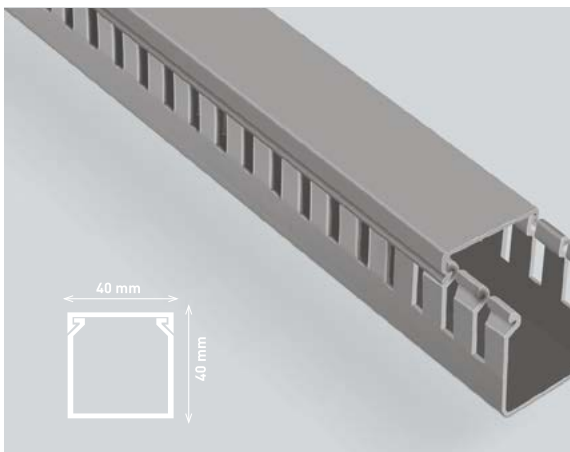
**40x40****Gri**  
Grey

Ürün Kodu	Product Code	001 005 040040 20 17
Ambalaj Şekli	Packing Type	Kutu - Box
Adet / m	Quantity / m	50 m
Ağırlık	Weight	15,375 kg
m <sup>3</sup> /	Volume	0,09272

## MEKS SERİSİ DELİKLİ KABLO KANALLARI MEKS SERIES SLOTTED TRUNKING

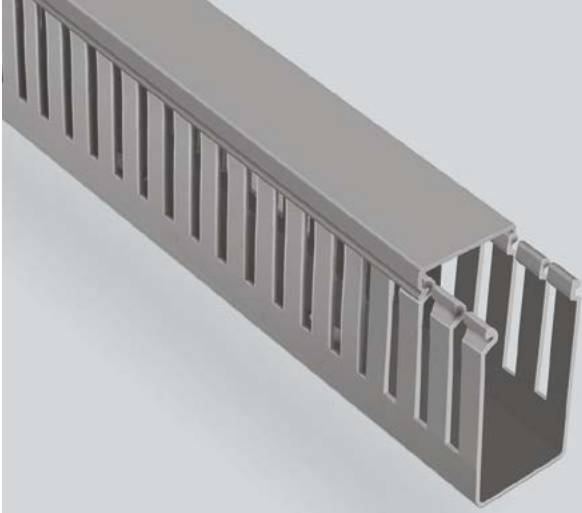

**40x60**

**Gri**  
Grey



Ürün Kodu	Product Code	001 005 040060 20 17
Ambalaj Şekli	Packing Type	Kutu - Box
Adet / m	Quantity / m	48 m
Ağırlık	Weight	19,680 kg
m <sup>3</sup> /	Volume	0,13392

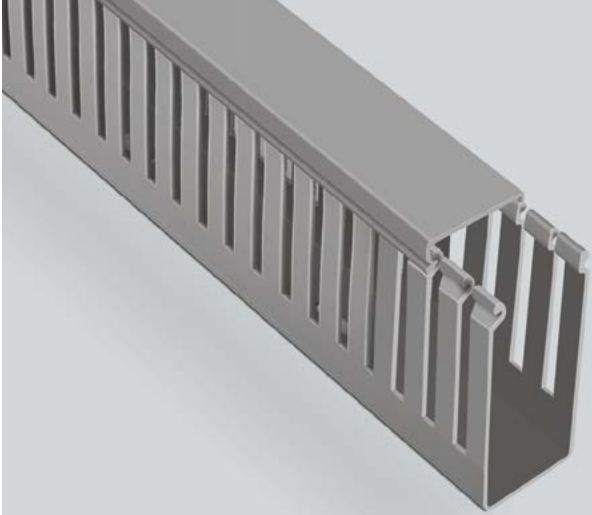

**40x80**

**Gri**  
Grey



Ürün Kodu	Product Code	001 005 040080 20 17
Ambalaj Şekli	Packing Type	Kutu - Box
Adet / m	Quantity / m	36 m
Ağırlık	Weight	21,706 kg
m <sup>3</sup> /	Volume	0,13392

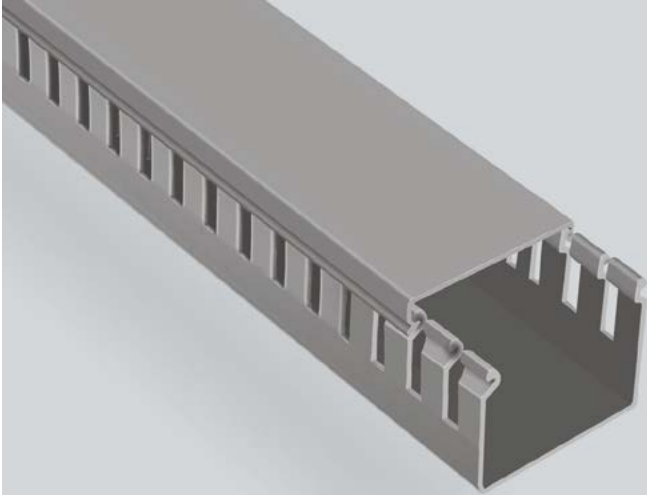

**60x40**

**Gri**  
Grey

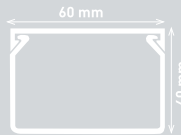

Ürün Kodu	Product Code	001 005 060040 20 17
Ambalaj Şekli	Packing Type	Kutu - Box
Adet / m	Quantity / m	48 m
Ağırlık	Weight	21,672 kg
m <sup>3</sup> /	Volume	0,13392

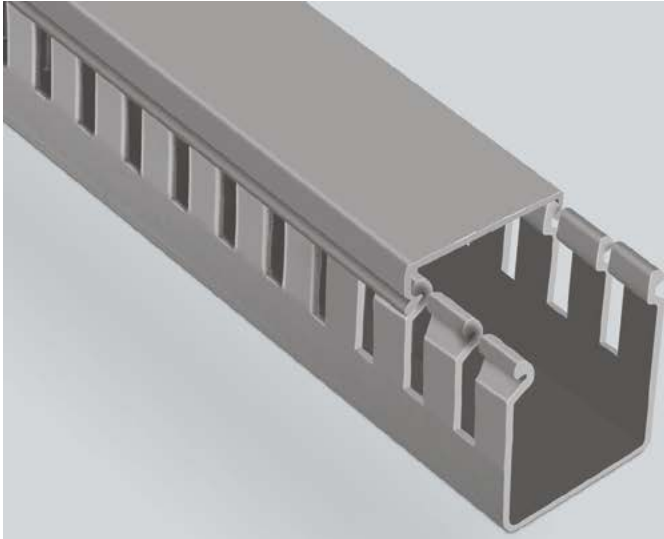
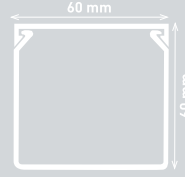
**MEKS SERİSİ DELİKLİ KABLO KANALLARI**  
MEKS SERIES SLOTTED TRUNKING**60x60****Gri**  
Grey

Ürün Kodu	Product Code	001 005 060060 20 17
Ambalaj Şekli	Packing Type	Kutu - Box
Adet / m	Quantity / m	32 m
Ağırlık	Weight	17,440 kg
m <sup>3</sup> /	Volume	0,13392

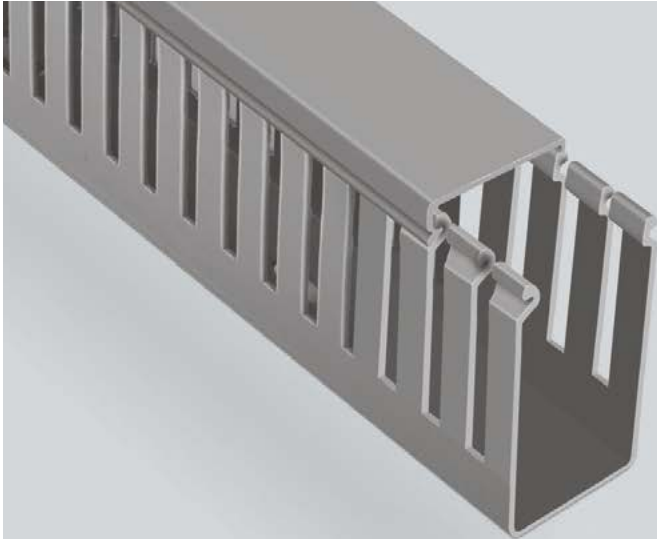
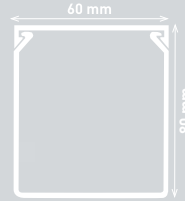
**60x80****Gri**  
Grey

Ürün Kodu	Product Code	001 005 060080 20 17
Ambalaj Şekli	Packing Type	Kutu - Box
Adet / m	Quantity / m	24 m
Ağırlık	Weight	15,120 kg
m <sup>3</sup> /	Volume	0,13392

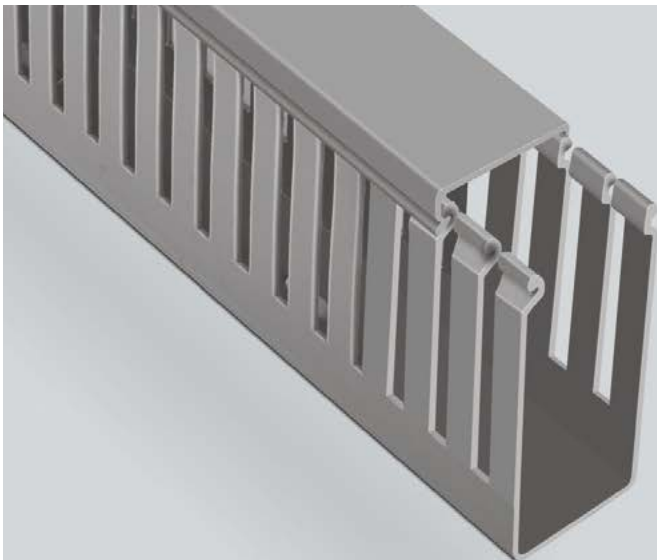
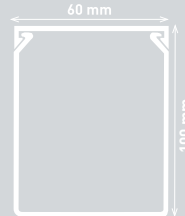
**60x100****Gri**  
Grey

Ürün Kodu	Product Code	001 005 060100 20 17
Ambalaj Şekli	Packing Type	Kutu - Box
Adet / m	Quantity / m	16 m
Ağırlık	Weight	11,680 kg
m <sup>3</sup> /	Volume	0,11029

## MEKS SERİSİ DELİKLİ KABLO KANALLARI MEKS SERIES SLOTTED TRUNKING

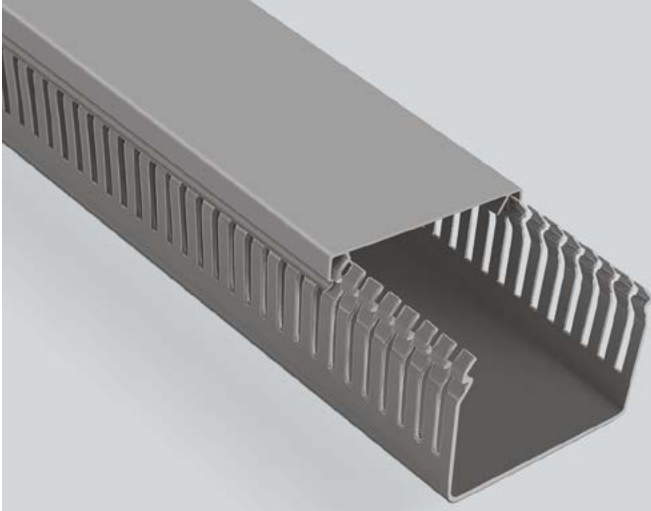

**80x60**

**Gri**  
Grey

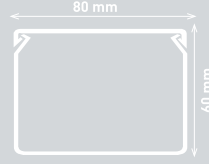

Ürün Kodu	Product Code	001 005 080060 20 17
Ambalaj Şekli	Packing Type	Kutu - Box
Adet / m	Quantity / m	24 m
Ağırlık	Weight	16,030 kg
m <sup>3</sup> /	Volume	0,13392

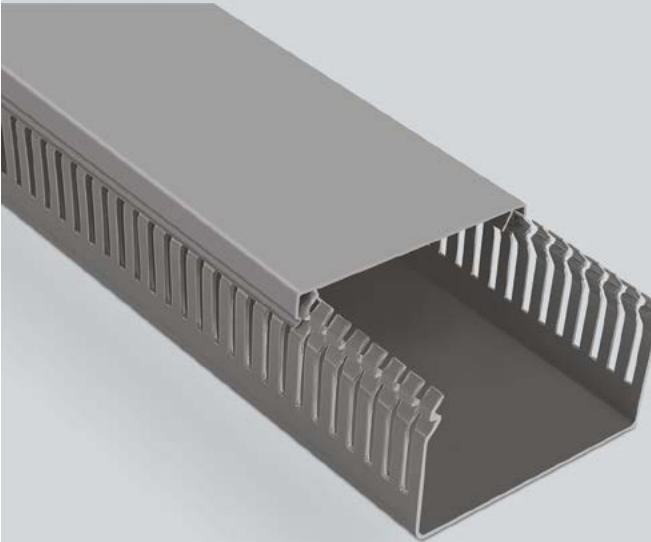

**100x60**

**Gri**  
Grey



Ürün Kodu	Product Code	001 005 100060 20 17
Ambalaj Şekli	Packing Type	Kutu - Box
Adet / m	Quantity / m	16 m
Ağırlık	Weight	13,590 kg
m <sup>3</sup> /	Volume	0,11029

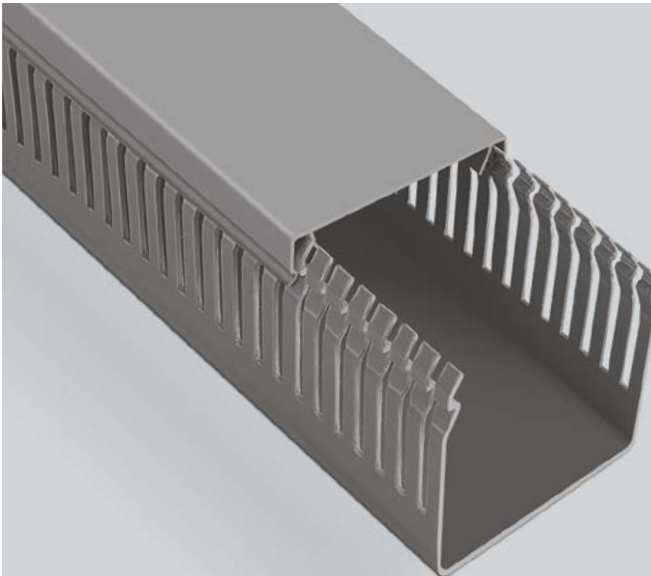

**100x100**

**Gri**  
Grey

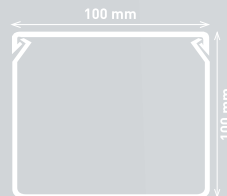

Ürün Kodu	Product Code	001 005 100100 20 17
Ambalaj Şekli	Packing Type	Kutu - Box
Adet / m	Quantity / m	8 m
Ağırlık	Weight	10,622 kg
m <sup>3</sup> /	Volume	0,11029

# ABS Plastik Panolar

ABS Plastic Panels



## PLASTİK OPAK KAPAKLI PANOLAR

### PLASTIC PANELS WITH OPAQUE LID

IP65 CE



Kod Code	Açıklama Description	Ambalaj Packing	Adet Quantity	Ağırlık Weight	Hacim Volume
001 046 203013 00 17	20x30x13	Kutu/Pack	1	1,684 kg	0,0084
001 046 253515 00 17	25x35x15	Kutu/Pack	1	2,359 kg	0,0140
001 046 304017 00 17	30x40x17	Kutu/Pack	1	3,076 kg	0,0216
001 046 304022 00 17	30x40x22	Kutu/Pack	1	3,475 kg	0,0276
001 046 355019 00 17	35x50x19	Kutu/Pack	1	4,306 kg	0,0350
001 046 405018 00 17	40x50x18	Kutu/Pack	1	4,456 kg	0,0454
001 046 405024 00 17	40x50x24	Kutu/Pack	1	5,546 kg	0,0501
001 046 406020 00 17	40x60x20	Kutu/Pack	1	5,779 kg	0,0508
001 046 507025 00 17	50x70x25	Kutu/Pack	1	9,502 kg	0,0908
001 046 608026 00 17	60x80x26	Kutu/Pack	1	13,39 kg	0,1299

## PLASTİK ŞEFFAF KAPAKLI PANOLAR

### PLASTIC PANELS WITH TRANSPARENT LID

IP65 CE



Kod Code	Açıklama Description	Ambalaj Packing	Adet Quantity	Ağırlık Weight	Hacim Volume
001 046 203013 00 44	20x30x13	Kutu/Pack	1	1,715 kg	0,0084
001 046 253515 00 44	25x35x15	Kutu/Pack	1	2,359 kg	0,0140
001 046 304017 00 44	30x40x17	Kutu/Pack	1	3,170 kg	0,0216
001 046 304022 00 44	30x40x22	Kutu/Pack	1	3,455 kg	0,0278
001 046 355019 00 44	35x50x19	Kutu/Pack	1	4,356 kg	0,0350
001 046 405018 00 44	40x50x18	Kutu/Pack	1	4,628 kg	0,0454
001 046 405024 00 44	40x50x24	Kutu/Pack	1	5,736 kg	0,0501
001 046 406020 00 44	40x60x20	Kutu/Pack	1	6,004 kg	0,0502
001 046 507025 00 44	50x70x25	Kutu/Pack	1	9,827 kg	0,0908
001 046 608026 00 44	60x80x26	Kutu/Pack	1	13,725 kg	0,1299



## OPAK KAPAKLI ABS OTOMAT PANOLAR

### OPAQUE COVERED ABS FUSE PANELS



 IP65 

Kod Code	Ölçü Dimension	Açıklama Description	Ambalaj Packing	Adet Quantity	Ağırlık Weight	Hacim Volume
001 046 253515 01 17	25x35x15	18 OTOMATLI / FUSE (9x2)	Kutu/Pack	1	8,50 kg	0,0140
001 046 304017 01 17	30x40x17	24 OTOMATLI / FUSE (12x2)	Kutu/Pack	1	8,50 kg	0,0216
001 046 355019 01 17	35x50x19	45 OTOMATLI / FUSE (15x3)	Kutu/Pack	1	8,50 kg	0,0350
001 046 406020 01 17	40x60x20	60 OTOMATLI / FUSE (15x4)	Kutu/Pack	1	8,50 kg	0,0502

## ŞEFFAF KAPAKLI ABS OTOMAT PANOLAR

### TRANSPARENT COVERED ABS FUSE PANELS



 IP65 

Kod Code	Ölçü Dimension	Açıklama Description	Ambalaj Packing	Adet Quantity	Ağırlık Weight	Hacim Volume
001 046 253515 01 44	25x35x15	18 OTOMATLI / FUSE (9x2)	Kutu/Pack	1	8,50 kg	0,0140
001 046 304017 01 44	30x40x17	24 OTOMATLI / FUSE (12x2)	Kutu/Pack	1	8,50 kg	0,0216
001 046 355019 01 44	35x50x19	45 OTOMATLI / FUSE (15x3)	Kutu/Pack	1	8,50 kg	0,0350
001 046 406020 01 44	40x60x20	60 OTOMATLI / FUSE (15x4)	Kutu/Pack	1	8,50 kg	0,0502

## GALVANİZ TABAN SAÇLARI

### GALVANIZED BASE SHEETS



Kod Code	Ölçü Dimension	Ürün Kalınlığı Product Thickness	Ambalaj Packing	Adet Quantity
000 702 203013 00 00	20x30x13	1 mm	Kutu/Pack	1
000 702 253515 00 00	25x35x15	1 mm	Kutu/Pack	1
000 702 304017 00 00	30x40x17	1 mm	Kutu/Pack	1
000 702 304022 00 00	30x40x22	1 mm	Kutu/Pack	1
000 702 355019 00 00	35x50x19	1 mm	Kutu/Pack	1
000 702 405018 00 00	40x50x17,5	1 mm	Kutu/Pack	1
000 702 405024 00 00	40x50x24	1 mm	Kutu/Pack	1
000 702 406020 00 00	40x60x20	1 mm	Kutu/Pack	1
000 702 507025 00 00	50x70x25	1 mm	Kutu/Pack	1

## MODULER KİTLER ve SEPERATÖRLER

### MODULAR KITS AND SEPERATORS



Kod Code	Ölçü Dimension	Açıklama Description	Ambalaj Packing	Adet Quantity
000 700 253515 01 17	25X35X15	18 OTOMATLI (9X2) 18 FUSE (9x12)	Kutu/Pack	1
000 700 304017 01 17	30X40X17	24 OTOMATLI (12X2) 24 FUSE (12x12)	Kutu/Pack	1
000 700 355019 01 17	35X50X19	45 OTOMATLI (15X3) 45 FUSE (15x3)	Kutu/Pack	1
000 700 406020 01 17	40X60X20	60 OTOMATLI (15X4) 60 FUSE (15x4)	Kutu/Pack	1
000 700 253515 00 17	25X35X15	PLASTİK PERDE PLASTIC CURTAIN	Kutu/Pack	1
000 700 304017 00 17	30X40X17	PLASTİK PERDE PLASTIC CURTAIN	Kutu/Pack	1
000 700 355019 00 17	35X50X19	PLASTİK PERDE PLASTIC CURTAIN	Kutu/Pack	1
000 700 406020 00 17	40X60X20	PLASTİK PERDE PLASTIC CURTAIN	Kutu/Pack	1

## PANO AKSESUARLARI

### PANEL ACCESSORIES

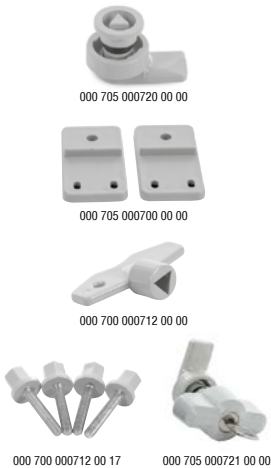



Kod Code	Açıklama Description	Ambalaj Packing	Adet Quantity
000 705 000720 00 00	PANO KİLİT GÖBEK TAKIMI (SET) LOCK CYLINDER KIT	Kutu/Pack	1
000 705 000700 00 00	PANO AKSESUARI (4'LÜ SET) PANEL WALL MOUNTING APPARATUS (4 SET)	Kutu/Pack	1
000 700 000711 00 17	PLASTİK PANO ÜÇGEN ANAHTAR PLASTIC TRIANGLE KEY	Kutu/Pack	1
000 700 000712 00 17	PANO SEPERATÖRÜ TUTTURMA VİDASI PANEL SEPERATOR HOLDING SCREW	Kutu/Pack	1
000 705 000721 00 00	PLASTİK KİLİTLENEBİLİR PANO (METAL) KİLİDİ PLASTIC LOCKABLE PANEL LOCK	Kutu/Pack	1



## PANO PRİZİ

### RAIL TYPE PANEL SOCKET

	Kod Code	Açıklama Description	Ambalaj Packing	Adet Quantity	Ağırlık Weight	Hacim Volume
	010 104 000157	MRP-16 1x16 RAY TİPİ PANO PRİZİ MRP-16 1x16 RAIL TYPE PANEL SOCKET	Kutu Pack	10	890,1 gr	0,0201
	010 104 000158	MRP-LED 10x16 RAY TİPİ PANO PRİZİ - LEDLİ MRP-LED 10 x16 RAIL TYPE PANEL SOCKET LED	Kutu Pack	10	890,1 gr	0,0201
	010 104 000159	MRP-UPS 1X16 RAY TİPİ PANO PRİZİ - UPS MRP-UPS 1X16 RAIL TYPE PANEL SOCKET UPS	Kutu Pack	10	890,1 gr	0,0201

# TERMOSTAT ve HİGROSTAT

## THERMOSTAT and HYGROSTAT

### ISITMA TERMOSTAT - HEATING THERMOSTAT - NK



Kod Code	Açıklama Description	Ambalaj Packing	Adet Quantity	Ağırlık Weight
048 095 000300	AYAR SAHASI SETTING FIELD	0-60°C	Kutu Pack	135
	KONTAK TİPİ CONTACT TYPE	NK		
	KORUMA SINIFI PROTECTED CLASS	IP20		

### SOĞUTMA TERMOSTAT - COOLING THERMOSTAT - NA



Kod Code	Açıklama Description	Ambalaj Packing	Adet Quantity	Ağırlık Weight
048 095 000301	AYAR SAHASI SETTING FIELD	0-60°C	Kutu Pack	135
	KONTAK TİPİ CONTACT TYPE	NA		
	KORUMA SINIFI PROTECTED CLASS	IP20		

### DUAL THERMOSTAT - DUAL THERMOSTAT - NK+NA

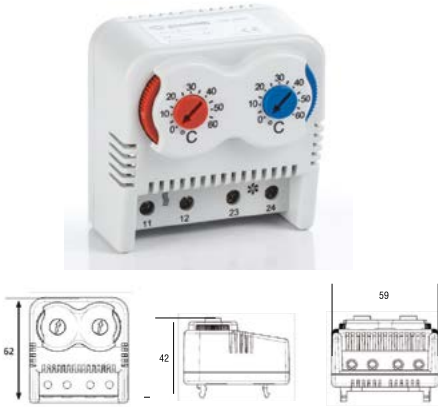

Kod Code	Açıklama Description	Ambalaj Packing	Adet Quantity	Ağırlık Weight
048 095 000302	AYAR SAHASI SETTING FIELD	0-60°C / 0-60°C	Kutu Pack	60
	KONTAK TİPİ CONTACT TYPE	NK+NA		
	KORUMA SINIFI PROTECTED CLASS	IP20		

### MEKANİK HİGROSTAT - MECHANICAL HYGROSTAT - 1CO



Kod Code	Açıklama Description	Ambalaj Packing	Adet Quantity	Ağırlık Weight
048 095 000303	AYAR SAHASI SETTING FIELD	%10- 90RH	Kutu Pack	30
	KONTAK TİPİ CONTACT TYPE	1CO		
	KORUMA SINIFI PROTECTED CLASS	IP20		

# DİJİTAL TERMOSTAT ve HİGROSTAT

## DIGITAL THERMOSTAT and HYGROSTAT

### PDT 50-150 SICAKLIK KONTROL CİHAZI - PDT 50-150 TEMPERATURE CONTROL DEVICE



ÜRÜN KODU / CODE	048 095 000304
ÖLÇÜLER / DIMENSIONS	36x90x65mm RAYA MONTAJ / RAIL MOUNTING
GÖSTERGE / INDICATOR	3 HANE 7 SEGMENT
SENSÖR / SENSOR	PTC
ÖLÇME SKALASI / MEASURING SCALE	-50...+150 °C
DUYARLILIK / SENSITIVITY	± C
DOĞRULUK / ACCURACY	±%1 (Tam Skalanın) (Full scale)
KONTROL DURUMU / CONTROL STATUS	ON-OFF
OUT ÇIKIŞI / OUTPUT	RÖLE, 250V AC, 2A, REZİSTİF YÜK / RESISTIVE LOAD
ALARM ÇIKIŞI / ALARM OUTPUT	RÖLE, 250V AC, 2A, REZİSTİF YÜK / RESISTIVE LOAD
HEAT SET AYARI / HEAT SETTING	LoL...UPL C (Hst)
ALARM SET AYARI / ALARM SETTING	AtP=Abs,-Ab; LoL...C(Ast) Atp=rEL, -rL; (HSt+rAL), (HSt-20)...(Hst+20) C
HEAT HİSTERESİZ / HEAT HYSTERESIS	1...20 C (Hhs)
ALARM HİSTERESİZ / ALARM HYSTERESIS	1...20 C (Hhs)
OFFSET / OFFSET	-20...+20 °C
ISITMA-SOĞUTMA / HEATING -COOLING	H-C; Ht(Isıtma- Heating), CL Soğutma-Cooling); Seçmeli-Optional
BESLEME VOLTAJ / SUPPLY VOLTAGE	100...240V AC, 50/60 Hz
GÜÇ TÜKETİMİ / POWER CONSUMPTION	←6VA
ÇALIŞMA SICAKLIĞI / OPERATING TEMP.	-20 °C...55 °C
İŞLETME İRTİFASI / OPERATING ALTITUDE	←2000m
ADET / QUANTITY	1

\* NOT: PTC SENSÖR CİHAZ DAHİLİNDEDİR.

\* NOTE: PTC SENSOR IS INCLUDED IN THE DEVICE.

### HT-310 SICAKLIK VE NEM KONTROL CİHAZI - HT-310 TEMPERATURE AND MOISTURE CONTROLLER



ÜRÜN KODU / CODE	048 095 000305
ÖLÇÜLER / DIMENSIONS	35x77mm
GÖSTERGE / INDICATOR	3 HANE 7 SEGMENT
SENSÖR / SENSOR	DİJİTAL SICAKLIK NEM SENSÖRÜ
ÖLÇME SKALASI / MEASURING SCALE	-19,9...+80,0C, 5...95%RH
DUYARLILIK / SENSITIVITY	±0,1C, ±1%RH
DOĞRULUK / ACCURACY	±%1 (C), ±%3 (%RH) (Tam Skalanın) (Full scale)
KONTROL DURUMU / CONTROL STATUS	ON-OFF
C OUT ÇIKIŞI / C OUTPUT	RÖLE (NA+NK), 250V AC, 2A, REZİSTİF YÜK / RESISTIVE LOAD
%RH OUT ÇIKIŞI / OUTPUT	RÖLE (NA), 250V AC, 2A, REZİSTİF YÜK / RESISTIVE LOAD
ISITMA- SOĞUTMA / HEATING -COOLING	(Isıtma- Heating), CL Soğutma-Cooling); Seçmeli-Optional
BESLEME VOLTAJ / SUPPLY VOLTAGE	100...220V AC, 50/60 Hz
GÜÇ TÜKETİMİ / POWER CONSUMPTION	←6VA
ÇALIŞMA SICAKLIĞI / OPERATING TEMP	0°C...55°C
İŞLETME İRTİFASI / OPERATING ALTITUDE	←2000m
ADET / QUANTITY	1

\* NOT: SICAKLIK VE NEM SENSÖRÜ CİHAZ DAHİLİNDEDİR.

\* NOTE: TEMPERATURE AND HUMIDITY SENSOR IS INCLUDED IN THE DEVICE

# TEPE FANLARI

## ROOF FANS



IP54



Poliüretan Conta



Radyal Fan

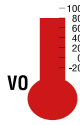

VO Alev İletmez ABS

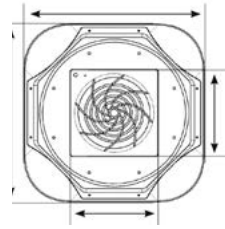

Kod Code	Fan Tipi Fan Type	Besleme Power Supply	Güç / Watt (W)	Nominal Akım Nominal Current	Gürültü Seviyesi Noise Level	Kapasite Capacity	Adet Quantity
048 095 000100	Ø172x163x51 AKSİYEL	220V AC 50/60 Hz	25/32W	0,11/0,15A	57 dB	400 m³/h	1
048 095 000101	Ø190x68 RADYAL	220V AC 50/60 Hz	58/75W	0,26/0,34A	62 dB	560 m³/h	1
048 095 000102	Ø220X71 RADYAL	220V AC 50/60 Hz	85/90W	0,38/0,44A	73 dB	970 m³/h	1



Vidasız hızlı ve kolay montaj !  
Fast and easy assembly without screws!



IP54



Poliüretan Conta



Radyal Fan

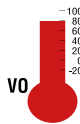

VO Alev İletmez ABS



Hızlı ve Kolay  
Montaj

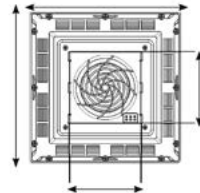

Kod Code	Fan Tipi Fan Type	Besleme Power Supply	Güç / Watt (W)	Nominal Akım Nominal Current	Gürültü Seviyesi Noise Level	Kapasite Capacity	Adet Quantity
048 095 000200	Ø172x163x51 AKSİYEL	220V AC 50/60 Hz	25/32W	0,11/0,15A	57 dB	400 m³/h	1
048 095 000201	Ø190x68 RADYAL	220V AC 50/60 Hz	58/75W	0,26/0,34A	62 dB	560 m³/h	1
048 095 000202	Ø220X71 RADYAL	220V AC 50/60 Hz	85/90W	0,38/0,44A	73 dB	970 m³/h	1

## KOLAY MONTAJ FİLTRELER

### EASY INSTALLATION FILTER



Kod Code	048 095 000400
Ölçü Dimension	120x120x20,5 mm
Kesim Ölçüsü Diameter	92x92 mm
Koruma Sınıfı Protect Class	IP54
Adet Quantity	200



Kod Code	048 095 000401
Ölçü Dimension	160x160x31 mm
Kesim Ölçüsü Diameter	125x125 mm
Koruma Sınıfı Protect Class	IP54
Adet Quantity	100



Kod Code	048 095 000402
Ölçü Dimension	210x210x31 mm
Kesim Ölçüsü Diameter	177x177 mm
Koruma Sınıfı Protect Class	IP54
Adet Quantity	100



Kod Code	048 095 000403
Ölçü Dimension	260x260x31 mm
Kesim Ölçüsü Diameter	223x223 mm
Koruma Sınıfı Protect Class	IP54
Adet Quantity	50



Kod Code	048 095 000404
Ölçü Dimension	325x325x31 mm
Kesim Ölçüsü Diameter	291x291 mm
Koruma Sınıfı Protect Class	IP54
Adet Quantity	50

## PROJE CEPLERİ

### PROJECT SIZE



Kod Code	048 095 000902 048 095 000903
Açıklama Description	A4 / A5
Adet Quantity	10

# FİLTRELİ FANLAR

## FILTER FANS



Kod / Code	048 095 000500
Ölçü / Dimension (mm)	120x120x58,5
Kesim Ölçüsü / Diameter (mm)	92x92
Fan Tipi / Fan Type	80x80x38
Besleme / Power Supply (V AC)	230V-50/60Hz
Güç / Power Consumption (W)	14 (13)
Hız / Speed (rpm)	2800
Filtreli / With Filter (m³/h)	30
Filtresiz / Unfiltered (m³/h)	41
Nominal Akım / Nominal Current (A)	0,08 / 0,07
Gürültü Seviyesi / Noise Level (db)	28 (31)
Adet / Quantity	1



Kod / Code	048 095 000501
Ölçü / Dimension (mm)	160x160x69
Kesim Ölçüsü / Diameter (mm)	125x125
Fan Tipi / Fan Type	120x120x38
Besleme / Power Supply (V AC)	230V-50/60Hz
Güç / Power Consumption (W)	26 (23)
Hız / Speed (rpm)	2700
Filtreli / With Filter (m³/h)	100
Filtresiz / Unfiltered (m³/h)	140
Nominal Akım / Nominal Current (A)	0,14 / 0,13
Gürültü Seviyesi / Noise Level (db)	42 (46)
Adet / Quantity	1



Kod / Code	048 095 000502
Ölçü / Dimension (mm)	120x120x58,5
Kesim Ölçüsü / Diameter (mm)	92x92
Fan Tipi / Fan Type	80x80x38
Besleme / Power Supply (V AC)	230V-50/60Hz
Güç / Power Consumption (W)	14 (13)
Hız / Speed (rpm)	2800
Filtreli / With Filter (m³/h)	30
Filtresiz / Unfiltered (m³/h)	41
Nominal Akım / Nominal Current (A)	0,8 / 0,7
Gürültü Seviyesi / Noise Level (db)	28 (31)
Adet / Quantity	1



Kod / Code	048 095 000600
Ölçü / Dimension (mm)	160x160x69
Kesim Ölçüsü / Diameter (mm)	125x125
Fan Tipi / Fan Type	120x120x38
Besleme / Power Supply (V AC)	230V-50/60Hz
Güç / Power Consumption (W)	26 (23)
Hız / Speed (rpm)	2700
Filtreli / With Filter (m³/h)	100
Filtresiz / Unfiltered (m³/h)	140
Nominal Akım / Nominal Current (A)	0,14 / 0,13
Gürültü Seviyesi / Noise Level (db)	42 (46)
Adet / Quantity	1



Kod / Code	048 095 000601
Ölçü / Dimension (mm)	210x210x83
Kesim Ölçüsü / Diameter (mm)	177x177
Fan Tipi / Fan Type	120x120x38
Besleme / Power Supply (V AC)	230V-50/60Hz
Güç / Power Consumption (W)	26 (23)
Hız / Speed (rpm)	2700
Filtreli / With Filter (m³/h)	125
Filtresiz / Unfiltered (m³/h)	175
Nominal Akım / Nominal Current (A)	0,14 / 0,13
Gürültü Seviyesi / Noise Level (db)	42 (46)
Adet / Quantity	1



Kod / Code	048 095 000602
Ölçü / Dimension (mm)	210x210x83
Kesim Ölçüsü / Diameter (mm)	177x177
Fan Tipi / Fan Type	173x163x51
Besleme / Power Supply (V AC)	230V-50/60Hz
Güç / Power Consumption (W)	37 (35)
Hız / Speed (rpm)	2400
Filtreli / With Filter (m³/h)	175
Filtresiz / Unfiltered (m³/h)	245
Nominal Akım / Nominal Current (A)	0,23 / 0,22
Gürültü Seviyesi / Noise Level (db)	52 (53)
Adet / Quantity	1



## FİLTRELİ FANLAR

### FILTER FANS

Kod / Code	048 095 000603
Ölçü / Dimension (mm)	260x260x103
Kesim Ölçüsü / Diameter (mm)	223x223
Fan Tipi / Fan Type	120x120x38
Besleme / Power Supply (V AC)	230V-50/60Hz
Güç / Power Consumption (W)	26 (23)
Hız / Speed (rpm)	2700
Filtreli / With Filter (m <sup>3</sup> /h)	115
Filtresiz / Unfiltered (m <sup>3</sup> /h)	130
Nominal Akım / Nominal Current (A)	0,14 / 0,13
Gürültü Seviyesi / Noise Level (db)	42 (46)
Adet / Quantity	1



Kod / Code	048 095 000604
Ölçü / Dimension (mm)	260x260x116
Kesim Ölçüsü / Diameter (mm)	223x223
Fan Tipi / Fan Type	172x126x51
Besleme / Power Supply (V AC)	230V-50/60Hz
Güç / Power Consumption (W)	37 (35)
Hız / Speed (rpm)	2400
Filtreli / With Filter (m <sup>3</sup> /h)	240
Filtresiz / Unfiltered (m <sup>3</sup> /h)	270
Nominal Akım / Nominal Current (A)	0,23 / 0,22
Gürültü Seviyesi / Noise Level (db)	52 (53)
Adet / Quantity	1



Kod / Code	048 095 000605
Ölçü / Dimension (mm)	260x260x111
Kesim Ölçüsü / Diameter (mm)	223x223
Fan Tipi / Fan Type	225x225x80
Besleme / Power Supply (V AC)	230V-50/60Hz
Güç / Power Consumption (W)	66 (75)
Hız / Speed (rpm)	2600
Filtreli / With Filter (m <sup>3</sup> /h)	650
Filtresiz / Unfiltered (m <sup>3</sup> /h)	900
Nominal Akım / Nominal Current (A)	0,35 / 0,38
Gürültü Seviyesi / Noise Level (db)	60 (63)
Adet / Quantity	1



Kod / Code	048 095 000606
Ölçü / Dimension (mm)	325x325x145
Kesim Ölçüsü / Diameter (mm)	291x291
Fan Tipi / Fan Type	225x225x80
Besleme / Power Supply (V AC)	230V-50/60Hz
Güç / Power Consumption (W)	66 (75)
Hız / Speed (rpm)	2600
Filtreli / With Filter (m <sup>3</sup> /h)	700
Filtresiz / Unfiltered (m <sup>3</sup> /h)	950
Nominal Akım / Nominal Current (A)	0,35 / 0,38
Gürültü Seviyesi / Noise Level (db)	60 (63)
Adet / Quantity	1



Kod / Code	048 095 000607
Ölçü / Dimension (mm)	325x325x111
Kesim Ölçüsü / Diameter (mm)	291x291
Fan Tipi / Fan Type	280x280x80
Besleme / Power Supply (V AC)	230V-50/60Hz
Güç / Power Consumption (W)	110 (140)
Hız / Speed (rpm)	2600
Filtreli / With Filter (m <sup>3</sup> /h)	850
Filtresiz / Unfiltered (m <sup>3</sup> /h)	1200
Nominal Akım / Nominal Current (A)	0,50 / 0,72
Gürültü Seviyesi / Noise Level (db)	65 (68)
Adet / Quantity	1



## PANO ISITICILARI HEATING



MİNİ ISITICI  
MPHT MINI HEATER

PTC ISITICI  
PHT PTC HEATER

SLİM ISITICI  
SLIM HEATER

Kod Code	Açıklama Description	Besleme Power Supply	Ölçü Dimension	IP Sınıfı IP Class	Bağlantı Connection	Adet Quantity
048 095 000700	15W PTC	100-250V AC-DC	60x50x27	IP20	KABLO / CABLE	1
048 095 000701	25W PTC	100-250V AC-DC	70x50x27	IP20	KABLO / CABLE	1
048 095 000702	30W PTC	100-250V AC-DC	128x70x59	IP20	KLEMENS / TERMINAL	1
048 095 000703	50W PTC	100-250V AC-DC	138x70x59	IP20	KLEMENS / TERMINAL	1
048 095 000704	75W PTC	100-250V AC-DC	178x70x59	IP20	KLEMENS / TERMINAL	1
048 095 000705	100W PTC	100-250V AC-DC	188x70x59	IP20	KLEMENS / TERMINAL	1
048 095 000706	150W PTC	100-250V AC-DC	228x70x59	IP20	KLEMENS / TERMINAL	1
048 095 000707	30W SLİM PTC	100-250V AC-DC	128x27x80	IP20	KLEMENS / TERMINAL	1
048 095 000708	50W SLİM PTC	100-250V AC-DC	138x27x80	IP20	KLEMENS / TERMINAL	1
048 095 000709	75W SLİM PTC	100-250V AC-DC	178x27x80	IP20	KLEMENS / TERMINAL	1
048 095 000710	100W SLİM PTC	100-250V AC-DC	188x27x80	IP20	KLEMENS / TERMINAL	1
048 095 000711	150W SLİM PTC	100-250V AC-DC	228x27x80	IP20	KLEMENS / TERMINAL	1

## FANLI PANO ISITICILARI HEATERS WITH FAN



FANLI PTC ISITICI  
PFHT FAN PTC HEATER

FANLI ISITICI  
PFHT FAN HEATER

400W PLASTİK FANLI ISITICI  
PFHT 400W PLASTIC FAN HEATER

Kod Code	Açıklama Description	Besleme Power Supply	Ölçü Dimension	IP Sınıfı IP Class	Bağlantı Connection	Adet Quantity
048 095 000800	100W FANLI WITH FAN PTC	230V AC 50/60 Hz	170x89x60	IP20	KLEMENS / TERMINAL	1
048 095 000801	150W FANLI WITH FAN PTC	230V AC 50/60 Hz	210x89x60	IP20	KLEMENS / TERMINAL	1
048 095 000802	250W FANLI REZİSTANS RES.HEATERS WITH FAN	230V AC 50/60 Hz	152x110x80	IP20	KLEMENS / TERMINAL	1
048 095 000803	500W FANLI REZİSTANS RES.HEATERS WITH FAN	230V AC 50/60 Hz	182x110x80	IP20	KLEMENS / TERMINAL	1
048 095 000804	750W FANLI REZİSTANS RES.HEATERS WITH FAN	230V AC 50/60 Hz	232x110x80	IP20	KLEMENS / TERMINAL	1
048 095 000805	200/300/400W FANLI PTC HEATERS WITH FAN	230V AC 50/60 Hz	99x70x67	IP20	KABLO / CABLE	1

## KABLO BAĞLARI CABLE TIES

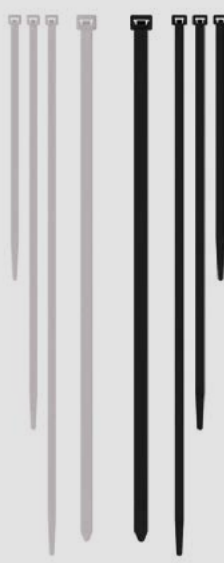
	Kod - Beyaz Code - White	Kod - Siyah Code - Black	Ölçü Dimension	Kutu Box	Adet Quantity
	062 129 025100	062 129 125100	2,5x100	1	1000
	062 129 025140	062 129 125140	2,5x140	1	100
	062 129 025200	062 129 125200	2,5x200	1	100
	062 129 036150	062 129 136150	3,6x150	1	100
	062 129 036205	062 129 136205	3,6x205	1	100
	062 129 036250	062 129 136250	3,6x250	1	100
	062 129 036300	062 129 136300	3,6x300	1	100
	062 129 036370	062 129 136370	3,6x370	1	100
	062 129 048200	062 129 148200	4,8x200	1	100
	062 129 048250	062 129 148250	4,8x250	1	100
	062 129 048300	062 129 148300	4,8x300	1	100
	062 129 048350	062 129 148350	4,8x350	1	100
	062 129 048400	062 129 148400	4,8x400	1	100
	062 129 048450	062 129 148450	4,8x450	1	100
	062 129 008250	062 129 108250	8x250	1	100
	062 129 008300	062 129 108300	8x300	1	100
	062 129 008380	062 129 108380	8x380	1	100
	062 129 008450	062 129 108450	8x450	1	100
	062 129 008550	062 129 108550	8x550	1	100
	062 129 008750	062 129 108750	8x750	1	100
062 129 009762	062 129 109762	9x762	1	100	

## KROŞE VE KLİPSLER CROCHET and CLIPSES

	Kod Code	Açıklama Description	Kutu Box	Adet Quantity
	062 129 132020	20x20 Yapışkanlı Kroşe / Adhesive Crochet	1	100
	062 129 132828	28x28 Yapışkanlı Kroşe / Adhesive Crochet	1	100
	062 129 131316	13x16 Yapışkanlı Klips / Adhesive Clips	1	100
	062 129 191325	13x25 Yapışkanlı Klips / Adhesive Clips	1	100
	062 129 132525	25x25 Yapışkanlı Klips / Adhesive Clips (Beyaz - White)	1	100
	062 129 142525	25x25 Yapışkanlı Klips / Adhesive Clips (Siyah - Black)	1	100
	062 129 151017	10x17 Vidalı Kroşe / Crochet W. Screw 10x17	1	250
	062 129 151530	15x30 Vidalı Kroşe / Crochet W. Screw 15x30	1	100
	062 129 151723	17x23 Vidalı Kroşe / Crochet W. Screw 17x23	1	250
	062 129 161004	Dübelli Kroşe 6 Delik için / Crochet with Socket 6 Holes	1	500
	062 129 171009	Duvar Kroşesi 6 Delik için / Wall Crochet 6 Holes	1	250
	033 129 100008	Kanal Kroşesi 8 Delik için / Trunking Crochet 8 Holes	1	250
	062 129 171011	Kanal Kroşesi 6 Delik için / Trunking Crochet 6 Holes	1	250
	062 129 500003	Kablo Klipsi / Cable Clips 6,4 (1/4")	1	100
	062 129 500004	Kablo Klipsi / Cable Clips 7,9 (5/16")	1	100
062 129 500005	Kablo Klipsi / Cable Clips 10,9 (3/8")	1	100	



**TESİSAT MALZEMELERİ**  
INSTALLATION MATERIALS

# COMFORT W Otomat Kutuları Fuse Boxes



- Estetik, sade, gözleri yormayan düz ve keskin hatlara sahip olan modern görsel tasarım
- 4 Vida ile sağlam kapak tesbiti
- Kolay ve pratik, arıza ihtimali olmayan açma-kapama özelliğine sahip cam
- Ip 40 koruma özelliği
- Sıva altı serisinde kolay ve tabana sıfır kırılan,
- Üstte-altta-yanda ve arkada yer alan çok sayıda kablo giriş pencereleri
- Çift taraflı (sağa ve sola) açılabilen cam
- Her iki yönde de kullanılabilen sıva altı ve sıva üstü gövdeler
- Sıva üstü gövdede arkada, altta ve üstte gizli-kolay kırılabilir kablo giriş pencereleri
- Sıva üstü serisinde pg 13-pg 16 rakor ve 21-25 mm çapta boru girişine müsait kablo giriş pencereleri
- Sıva altı serisinde max 32 mm çapta boru girişine sahip kablo giriş pencereleri
- Kablo bağlantıları için geniş iç hacim
- Mukavemetli alt ve yan duvarlar
- Sıva altı ve sıva üstü serisinde ortak kullanılabilen kapak ve cam

- Modern visual design with aesthetic, simple, flat and sharp lines
- Cover fixing with 4 screws
- Easy and practical, open-close glass with no possibility of malfunction
- Ip 40 protection feature
- Easy and zero based in flush mounted series
- Many cable entry windows on the top-bottom-side and rear
- Double-sided (right and left) opened glass
- Flush and surface-mounted bodies that can be used in both side
- Easy-to-break cable entry windows at the rear, top and bottom on surface mounted body
- Cable entry windows suitable for pipe entry of 16 gauge pg 13-pg diameter and 21-25 mm diameter in the surface mounted series
- Cable entry windows with pipe entrance of maximum 32 mm diameter in flush mounted series
- Wider internal volume for cable connections
- Strengthened bottom and side walls
- Cover and glass that can be used in flush and surface mounted series



## BOYUTLAR • DIMENSIONS

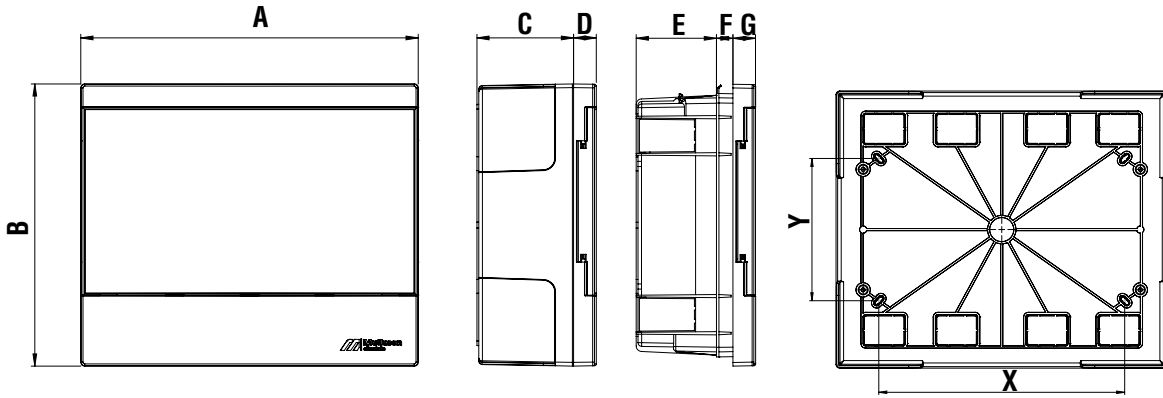





ÖLÇÜLER / SIZES	SIVA ALTI FLUSH		A	B	C	D	E	F	G	X	Y
		6	167	180			65,5	13,5	18,5		
9	221	180			65,5	13,5	18,5				
12	275	230			65,5	13,5	18,5				
18	383	230			65,5	13,5	18,5				
24	275	345			65,5	13,5	18,5				
36	275	460			65,5	13,5	18,5				
SIVA ÜSTÜ SURFACE	6	167	180	78,8	18,5					70	80
	9	221	180	78,8	18,5					133	80
12	275	230	78,8	18,5						204	118
18	383	230	78,8	18,5						312	118
24	275	345	78,8	18,5						204	233
36	275	460	78,8	18,5						204	348

Terminal koruma seviyesi(Koruma Sınıfı) : IP 40  
 Kutuların tipi : Dikdörtgen kutulardır  
 Tesis sırasındaki sıcaklık aralığı : -25°C / +60°C  
 Yalıtım direnci : 5 MΩ' un üzerindedir  
 Yüksek gerilime dayanım : 3750 V AC(alternatif akım,  
 220 V /400 V ~50 Hz)





Terminal protection level (Protection class) : IP 40  
 Types of boxes : Rectangular boxes  
 The temperature range during installation : -25°C / +60°C  
 Insulation resistance : over 5 MΩ  
 High tensile resistance : 3750 V AC  
 (alternative current, 220 V /400 V ~50 Hz)

**COMFORT W OTOMAT KUTULARI**  
**COMFORT FUSE BOXES**

IP40

001 057 100006 00 00 Alev Yayan  
Flammable001 057 120006 00 00 Halogen Free  
Alev Yayan Flammable 001 057 110006 00 00     
Alev Yaymayan  
Non Flammable**6 'lı Sıva Üstü W Otomat Kutusu**  
Surface-Mounted Fuse Box , 6 Fuse



Ambalaj Şekli / Package Type	Kutu / Pack
Adet / m / Quantity / m	20
Ağırlık / Weight	10,46 / 10,78 / 11,68 kg
m <sup>3</sup> / Volume	0,06766

001 057 000006 00 00 Alev Yayan  
Flammable001 057 020006 00 00 Halogen Free  
Alev Yayan Flammable 001 057 010006 00 00     
Alev Yaymayan  
Non Flammable**6 'lı Sıva Altı W Otomat Kutusu**  
Flush-Mounted Fuse Box , 6 Fuse

Ambalaj Şekli / Package Type	Kutu / Pack
Adet / m / Quantity / m	20
Ağırlık / Weight	9,88 / 10,20 / 10,90 kg
m <sup>3</sup> / Volume	0,06766

001 057 100009 00 00 Alev Yayan  
Flammable001 057 120009 00 00 Halogen Free  
Alev Yayan Flammable 001 057 110009 00 00     
Alev Yaymayan  
Non Flammable**9 'lu Sıva Üstü W Otomat Kutusu**  
Surface-Mounted Fuse Box , 9 Fuse

Ambalaj Şekli / Package Type	Kutu / Pack
Adet / m / Quantity / m	20
Ağırlık / Weight	12,94 / 13,00 / 13,94 kg
m <sup>3</sup> / Volume	0,09150

001 057 000009 00 00 Alev Yayan  
Flammable001 057 020009 00 00 Halogen Free  
Alev Yayan Flammable 001 057 010009 00 00     
Alev Yaymayan  
Non Flammable**9 'lu Sıva Altı W Otomat Kutusu**  
Flush-Mounted Fuse Box , 9 Fuse

Ambalaj Şekli / Package Type	Kutu / Pack
Adet / m / Quantity / m	20
Ağırlık / Weight	12,352 / 12,66 / 12,36 kg
m <sup>3</sup> / Volume	0,09150

001 057 100012 00 00 Alev Yayan  
Flammable001 057 120012 00 00 Halogen Free  
Alev Yayan Flammable 001 057 100012 00 00     
Alev Yaymayan  
Non Flammable**12 'li Sıva Üstü W Otomat Kutusu**  
Surface-Mounted Fuse Box , 12 Fuse

Ambalaj Şekli / Package Type	Kutu / Pack
Adet / m / Quantity / m	10
Ağırlık / Weight	8,73 / 9,00 / 9,54 kg
m <sup>3</sup> / Volume	0,07207

001 057 000012 00 00 Alev Yayan  
Flammable001 057 020012 00 00 Halogen Free  
Alev Yayan Flammable 001 057 010012 00 00     
Alev Yaymayan  
Non Flammable**12 'li Sıva Altı W Otomat Kutusu**  
Flush-Mounted Fuse Box , 12 Fuse

Ambalaj Şekli / Package Type	Kutu / Pack
Adet / m / Quantity / m	10
Ağırlık / Weight	8,73 / 9,00 / 9,54 kg
m <sup>3</sup> / Volume	0,07207



- 001 057 100018 00 00 Alev Yayan  
Flammable
- 001 057 120018 00 00 Halogen Free  
Alev Yayan  
Flammable 
- 001 057 110018 00 00     
Alev Yaymayan  
Non Flammable

**18 'li Sıva Üstü W Otomat Kutusu**  
Surface-Mounted Fuse Box , 18 Fuse

Ambalaj Şekli / Package Type	Kutu / Pack
Adet / m / Quantity / m	10
Ağırlık / Weight	12,604 / 12,70 / 13,83 kg
m <sup>3</sup> / Volume	0,10181



- 001 057 000018 00 00 Alev Yayan  
Flammable
- 001 057 020018 00 00 Halogen Free  
Alev Yayan  
Flammable 
- 001 057 010018 00 00     
Alev Yaymayan  
Non Flammable

**18 'li Sıva Altı W Otomat Kutusu**  
Flush-Mounted Fuse Box , 18 Fuse

Ambalaj Şekli / Package Type	Kutu / Pack
Adet / m / Quantity / m	10
Ağırlık / Weight	11,738 / 11,63 / 12,27 kg
m <sup>3</sup> / Volume	0,10181



- 001 057 100024 00 00 Alev Yayan  
Flammable
- 001 057 120024 00 00 Halogen Free  
Alev Yayan  
Flammable 
- 001 057 110024 00 00     
Alev Yaymayan  
Non Flammable

**24 'lü Sıva Üstü W Otomat Kutusu**  
Surface-Mounted Fuse Box , 24 Fuse

Ambalaj Şekli / Package Type	Kutu / Pack
Adet / m / Quantity / m	5
Ağırlık / Weight	7,447 / 7,10 / 6,175 kg
m <sup>3</sup> / Volume	0,05507



- 001 057 000024 00 00 Alev Yayan  
Flammable
- 001 057 020024 00 00 Halogen Free  
Alev Yayan  
Flammable 
- 001 057 010024 00 00     
Alev Yaymayan  
Non Flammable

**24 'lü Sıva Altı W Otomat Kutusu**  
Flush-Mounted Fuse Box , 24 Fuse

Ambalaj Şekli / Package Type	Kutu / Pack
Adet / m / Quantity / m	5
Ağırlık / Weight	6,941 / 6,79 / 7,22 kg
m <sup>3</sup> / Volume	0,05507



- 001 057 100036 00 00 Alev Yayan  
Flammable
- 001 057 120036 00 00 Halogen Free  
Alev Yayan  
Flammable 
- 001 057 110036 00 00     
Alev Yaymayan  
Non Flammable

**36 'lı Sıva Üstü W Otomat Kutusu**  
Surface-Mounted Fuse Box , 36 Fuse

Ambalaj Şekli / Package Type	Kutu / Pack
Adet / m / Quantity / m	5
Ağırlık / Weight	9,385 / 9,25 / 7,775kg
m <sup>3</sup> / Volume	0,07306



- 001 057 000036 00 00 Alev Yayan  
Flammable
- 001 057 020036 00 00 Halogen Free  
Alev Yayan  
Flammable 
- 001 057 010036 00 00     
Alev Yaymayan  
Non Flammable

**36 'lı Sıva Altı W Otomat Kutusu**  
Flush-Mounted Fuse Box , 36 Fuse

Ambalaj Şekli / Package Type	Kutu / Pack
Adet / m / Quantity / m	5
Ağırlık / Weight	8,950 / 8,825 / 9,58 kg
m <sup>3</sup> / Volume	0,07306



## COMFORT W OTOMAT KUTULARI COMFORT FUSE BOXES

IP40

### COMFORT MÜHÜRLÜ SİGORTA KUTULARI SEALED FUSE BOXES

 <p><b>1 'li Sıva Üstü Mühürlü Sigorta Kutusu</b> Surface Mounted Sealed Fuse Box, 1 Fuse</p> <p><b>001 057 200001 00 00</b></p> <table border="1"> <tr><td>Ambalaj Şekli / Package Type</td><td>Kutu / Pack</td></tr> <tr><td>Adet / m / Quantity / m</td><td>20</td></tr> <tr><td>Ağırlık / Weight</td><td>1,42 kg</td></tr> <tr><td>m<sup>3</sup> / Volume</td><td>0,01096</td></tr> </table>	Ambalaj Şekli / Package Type	Kutu / Pack	Adet / m / Quantity / m	20	Ağırlık / Weight	1,42 kg	m <sup>3</sup> / Volume	0,01096	 <p><b>1-2 'li Sıva Üstü Mühürlü Sigorta Kutusu</b> Surface Mounted Sealed Fuse Box, 1-2 Fuses</p> <p><b>001 057 200002 00 00</b></p> <table border="1"> <tr><td>Ambalaj Şekli / Package Type</td><td>Kutu / Pack</td></tr> <tr><td>Adet / m / Quantity / m</td><td>20</td></tr> <tr><td>Ağırlık / Weight</td><td>1,75 kg</td></tr> <tr><td>m<sup>3</sup> / Volume</td><td>0,01412</td></tr> </table>	Ambalaj Şekli / Package Type	Kutu / Pack	Adet / m / Quantity / m	20	Ağırlık / Weight	1,75 kg	m <sup>3</sup> / Volume	0,01412	 <p><b>3-4 'li Sıva Üstü Mühürlü Sigorta Kutusu</b> Surface Mounted Sealed Fuse Box, 3-4 Fuses</p> <p><b>001 057 200004 00 00</b></p> <table border="1"> <tr><td>Ambalaj Şekli / Package Type</td><td>Kutu / Pack</td></tr> <tr><td>Adet / m / Quantity / m</td><td>10</td></tr> <tr><td>Ağırlık / Weight</td><td>1,212 kg</td></tr> <tr><td>m<sup>3</sup> / Volume</td><td>0,01117</td></tr> </table>	Ambalaj Şekli / Package Type	Kutu / Pack	Adet / m / Quantity / m	10	Ağırlık / Weight	1,212 kg	m <sup>3</sup> / Volume	0,01117
Ambalaj Şekli / Package Type	Kutu / Pack																									
Adet / m / Quantity / m	20																									
Ağırlık / Weight	1,42 kg																									
m <sup>3</sup> / Volume	0,01096																									
Ambalaj Şekli / Package Type	Kutu / Pack																									
Adet / m / Quantity / m	20																									
Ağırlık / Weight	1,75 kg																									
m <sup>3</sup> / Volume	0,01412																									
Ambalaj Şekli / Package Type	Kutu / Pack																									
Adet / m / Quantity / m	10																									
Ağırlık / Weight	1,212 kg																									
m <sup>3</sup> / Volume	0,01117																									

### COMFORT MÜHÜRLÜ SİGORTA KUTULARI (ALEV YAYMAYAN) MEKS SERIES SEALED FUSE BOXES (NON FLAMMABLE)

 <p><b>1 'li Sıva Üstü Mühürlü Sigorta Kutusu</b> Surface Mounted Sealed Fuse Box, 1 Fuse TSE CE </p> <p><b>001 057 210001 00 00</b></p> <table border="1"> <tr><td>Ambalaj Şekli / Package Type</td><td>Kutu / Pack</td></tr> <tr><td>Adet / m / Quantity / m</td><td>20</td></tr> <tr><td>Ağırlık / Weight</td><td>1,62 kg</td></tr> <tr><td>m<sup>3</sup> / Volume</td><td>0,01096</td></tr> </table>	Ambalaj Şekli / Package Type	Kutu / Pack	Adet / m / Quantity / m	20	Ağırlık / Weight	1,62 kg	m <sup>3</sup> / Volume	0,01096	 <p><b>1-2 'li Sıva Üstü Mühürlü Sigorta Kutusu</b> Surface Mounted Sealed Fuse Box, 1-2 Fuses TSE CE </p> <p><b>001 057 210002 00 00</b></p> <table border="1"> <tr><td>Ambalaj Şekli / Package Type</td><td>Kutu / Pack</td></tr> <tr><td>Adet / m / Quantity / m</td><td>20</td></tr> <tr><td>Ağırlık / Weight</td><td>1,91 kg</td></tr> <tr><td>m<sup>3</sup> / Volume</td><td>0,01412</td></tr> </table>	Ambalaj Şekli / Package Type	Kutu / Pack	Adet / m / Quantity / m	20	Ağırlık / Weight	1,91 kg	m <sup>3</sup> / Volume	0,01412	 <p><b>3-4 'li Sıva Üstü Mühürlü Sigorta Kutusu</b> Surface Mounted Sealed Fuse Box, 3-4 Fuses TSE CE </p> <p><b>001 057 210004 00 00</b></p> <table border="1"> <tr><td>Ambalaj Şekli / Package Type</td><td>Kutu / Pack</td></tr> <tr><td>Adet / m / Quantity / m</td><td>10</td></tr> <tr><td>Ağırlık / Weight</td><td>1,275 kg</td></tr> <tr><td>m<sup>3</sup> / Volume</td><td>0,01117</td></tr> </table>	Ambalaj Şekli / Package Type	Kutu / Pack	Adet / m / Quantity / m	10	Ağırlık / Weight	1,275 kg	m <sup>3</sup> / Volume	0,01117
Ambalaj Şekli / Package Type	Kutu / Pack																									
Adet / m / Quantity / m	20																									
Ağırlık / Weight	1,62 kg																									
m <sup>3</sup> / Volume	0,01096																									
Ambalaj Şekli / Package Type	Kutu / Pack																									
Adet / m / Quantity / m	20																									
Ağırlık / Weight	1,91 kg																									
m <sup>3</sup> / Volume	0,01412																									
Ambalaj Şekli / Package Type	Kutu / Pack																									
Adet / m / Quantity / m	10																									
Ağırlık / Weight	1,275 kg																									
m <sup>3</sup> / Volume	0,01117																									

### COMFORT MÜHÜRLÜ SİGORTA KUTULARI H.FREE (ALEV YAYAN) MEKS SERIES SEALED FUSE BOXES H.FREE (FLAMMABLE)

 <p><b>1 'li Sıva Üstü Mühürlü Sigorta Kutusu</b> Surface Mounted Sealed Fuse Box, 1 Fuse </p> <p><b>001 057 220001 00 00</b></p> <table border="1"> <tr><td>Ambalaj Şekli / Package Type</td><td>Kutu / Pack</td></tr> <tr><td>Adet / m / Quantity / m</td><td>20</td></tr> <tr><td>Ağırlık / Weight</td><td>1,42 kg</td></tr> <tr><td>m<sup>3</sup> / Volume</td><td>0,01096</td></tr> </table>	Ambalaj Şekli / Package Type	Kutu / Pack	Adet / m / Quantity / m	20	Ağırlık / Weight	1,42 kg	m <sup>3</sup> / Volume	0,01096	 <p><b>1-2 'li Sıva Üstü Mühürlü Sigorta Kutusu</b> Surface Mounted Sealed Fuse Box, 1-2 Fuses </p> <p><b>001 057 220002 00 00</b></p> <table border="1"> <tr><td>Ambalaj Şekli / Package Type</td><td>Kutu / Pack</td></tr> <tr><td>Adet / m / Quantity / m</td><td>20</td></tr> <tr><td>Ağırlık / Weight</td><td>1,75 kg</td></tr> <tr><td>m<sup>3</sup> / Volume</td><td>0,01412</td></tr> </table>	Ambalaj Şekli / Package Type	Kutu / Pack	Adet / m / Quantity / m	20	Ağırlık / Weight	1,75 kg	m <sup>3</sup> / Volume	0,01412	 <p><b>3-4 'li Sıva Üstü Mühürlü Sigorta Kutusu</b> Surface Mounted Sealed Fuse Box, 3-4 Fuses </p> <p><b>001 057 220004 00 00</b></p> <table border="1"> <tr><td>Ambalaj Şekli / Package Type</td><td>Kutu / Pack</td></tr> <tr><td>Adet / m / Quantity / m</td><td>10</td></tr> <tr><td>Ağırlık / Weight</td><td>0,94 kg</td></tr> <tr><td>m<sup>3</sup> / Volume</td><td>0,01117</td></tr> </table>	Ambalaj Şekli / Package Type	Kutu / Pack	Adet / m / Quantity / m	10	Ağırlık / Weight	0,94 kg	m <sup>3</sup> / Volume	0,01117
Ambalaj Şekli / Package Type	Kutu / Pack																									
Adet / m / Quantity / m	20																									
Ağırlık / Weight	1,42 kg																									
m <sup>3</sup> / Volume	0,01096																									
Ambalaj Şekli / Package Type	Kutu / Pack																									
Adet / m / Quantity / m	20																									
Ağırlık / Weight	1,75 kg																									
m <sup>3</sup> / Volume	0,01412																									
Ambalaj Şekli / Package Type	Kutu / Pack																									
Adet / m / Quantity / m	10																									
Ağırlık / Weight	0,94 kg																									
m <sup>3</sup> / Volume	0,01117																									

# COMFORT W Otomat Zayıf akım kutusu

Comfort fuse and  
low-current  
boxes



## İkisi bir arada

Hem sigorta kutusu hem zayıf akım kutusu

- İçerisine Modem, Acces Point, Switch, Tv Dağıtıcı ve cihazların enerji beslemesi için grup priz montajı yapılabilen zayıf akım kutuları ile elektrik ve data tesisatlarındaki karmaşıklığı minimize etmek, arıza tespitini hızlı bir şekilde çözüme kavuşturmak mümkündür.
- Kullanacağınız cihaz sayısına göre farklı ebatlardaki zayıf akım kutularımız, tabanı sac - kapağı plastik ya da tamamı sac olan seçenekleriyle ürün gamımıza eklenmiştir

## Two in One

Both the fuse box and the weak current box

- It is possible to minimize the complexity of electrical and data installations and solve the problem quickly with Modem, Access Point, Switch, TV Distributor and weak current boxes which can be grouped for power supply of devices.
- Depending on the number of devices you will use, our product range has been added with the choices of low current boxes in different sizes, sheet metal - cover plastic or all sheet metal.





## BOYUTLAR • DIMENSIONS

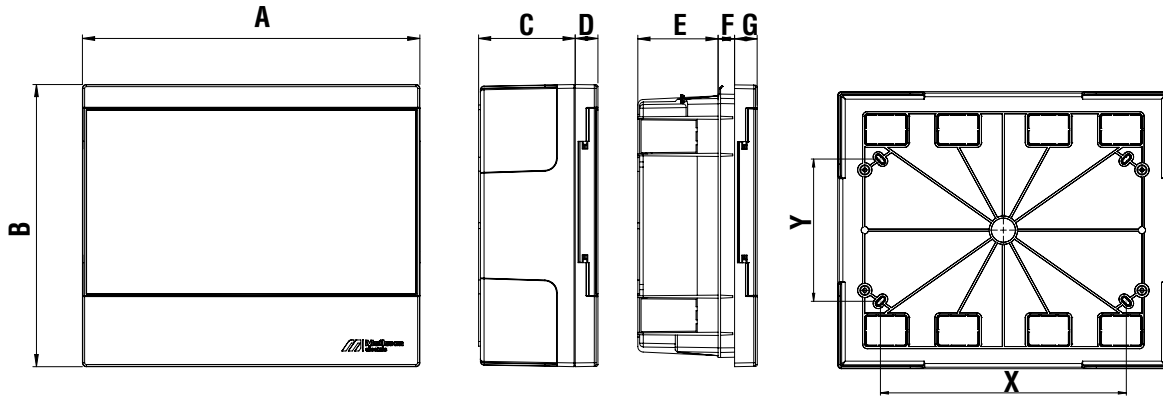

ÖLÇÜLER / SIZES	SIVA ALTI FLUSH		A	B	C	D	E	F	G	X	Y
		ZAYIF AKIM 205 X 250 (İÇ ÖLÇÜ)	275	230			65,5	13,5	18,5		
ZAYIF AKIM 248 X 318 (İÇ ÖLÇÜ)	275	345			65,5	13,5	18,5				
12 SİGORTA + ZAYIF AKIM	275	345			65,5	13,5	18,5				
24 SİGORTA + ZAYIF AKIM	275	460			65,5	13,5	18,5				
SIVA ÜSTÜ SURFACE		A	B	C	D	E	F	G	X	Y	
	ZAYIF AKIM 205 X 250 (İÇ ÖLÇÜ)	275	230	78,8	18,5				204	118	
	ZAYIF AKIM 248 X 318 (İÇ ÖLÇÜ)	275	345	78,8	18,5				204	233	
	12 SİGORTA + ZAYIF AKIM	275	345	78,8	18,5				204	233	
	24 SİGORTA + ZAYIF AKIM	275	460	78,8	18,5				204	348	

## AKSESUAR • ACCESSORY



**001 057 001236 00 00**

COMFORT ZAYIF AKIM ÖRTME PARÇASI  
COMFORT COVER TOOL





Ambalaj Şekli / Package Type	Kutu / Pack
Adet / m / Quantity / m	50
Ağırlık / Weight	0.46 kg
m <sup>3</sup> / Volume	0.001

# COMFORT W OTOMAT ZAYIF AKIM KUTULARI





## COMFORT FUSE AND LOW-CURRENT BOXES

IP40







001 057 101012 00 00	Alev Yayan Flammable
001 057 121012 00 00	Halogen Free Alev Yayan Flammable 
001 057 111012 00 00	Alev Yaymayan Non Flammable   
<b>Sıva Üstü Zayıf Akım Kutusu (225x270)</b> Surface Mounted Low Current Box (225x270)	
Ambalaj Şekli / Package Type	Kutu / Pack
Adet / m / Quantity / m	10
Ağırlık / Weight	8,21 kg
m <sup>3</sup> / Volume	0,07207







001 057 001012 00 00	Alev Yayan Flammable
001 057 021012 00 00	Halogen Free Alev Yayan Flammable 
001 057 011012 00 00	Alev Yaymayan Non Flammable   
<b>Sıva Üstü Zayıf Akım Kutusu (225x270)</b> Surface Mounted Low Current Box (225x270)	
Ambalaj Şekli / Package Type	Kutu / Pack
Adet / m / Quantity / m	10
Ağırlık / Weight	8,445 kg
m <sup>3</sup> / Volume	0,07207



001 057 101020 00 00	Alev Yayan Flammable
001 057 121020 00 00	Halogen Free Alev Yayan Flammable 
001 057 111020 00 00	Alev Yaymayan Non Flammable   
<b>Sıva Üstü Zayıf Akım Kutusu (270x340)</b> Surface Mounted Low Current Box (270x340)	
Ambalaj Şekli / Package Type	Kutu / Pack
Adet / m / Quantity / m	5
Ağırlık / Weight	6,94 kg
m <sup>3</sup> / Volume	0,05507



001 057 001020 00 00	Alev Yayan Flammable
001 057 021020 00 00	Halogen Free Alev Yayan Flammable 
001 057 011020 00 00	Alev Yaymayan Non Flammable   
<b>Sıva Altı Zayıf Akım Kutusu (270x340)</b> Flush Mounted Low Current Box (270x340)	
Ambalaj Şekli / Package Type	Kutu / Pack
Adet / m / Quantity / m	5
Ağırlık / Weight	6,94 kg
m <sup>3</sup> / Volume	0,05507



001 057 101024 00 00	Alev Yayan Flammable
001 057 121024 00 00	Halogen Free Alev Yayan Flammable 
001 057 111024 00 00	Alev Yaymayan Non Flammable   
<b>Sıva Üstü 12'li Sigorta +Zayıf Akım Kutusu</b> Surface Mounted Fuse Box (12)+ Low Current Box	
Ambalaj Şekli / Package Type	Kutu / Pack
Adet / m / Quantity / m	5
Ağırlık / Weight	6,835 kg
m <sup>3</sup> / Volume	0,05507



001 057 001024 00 00	Alev Yayan Flammable
001 057 021024 00 00	Halogen Free Alev Yayan Flammable 
001 057 011024 00 00	Alev Yaymayan Non Flammable   
<b>Sıva Altı 12'li Sigorta +Zayıf Akım Kutusu</b> Flush Mounted Fuse Box (12)+ Low Current Box	
Ambalaj Şekli / Package Type	Kutu / Pack
Adet / m / Quantity / m	5
Ağırlık / Weight	6,835 kg
m <sup>3</sup> / Volume	0,05507



001 057 101036 00 00	Alev Yayan Flammable
001 057 121036 00 00	Halogen Free Alev Yayan Flammable 
001 057 111036 00 00	Alev Yaymayan Non Flammable   
<b>Sıva Üstü 24'lü Sigorta +Zayıf Akım Kutusu</b> Surface Mounted Fuse Box (24)+ Low Current Box	
Ambalaj Şekli / Package Type	Kutu / Pack
Adet / m / Quantity / m	5
Ağırlık / Weight	9,39 kg
m <sup>3</sup> / Volume	0,07306



001 057 001036 00 00	Alev Yayan Flammable
001 057 021036 00 00	Halogen Free Alev Yayan Flammable 
001 057 011036 00 00	Alev Yaymayan Non Flammable   
<b>Sıva Altı 24'lü Sigorta +Zayıf Akım Kutusu</b> Flush Mounted Fuse Box (24)+ Low Current Box	
Ambalaj Şekli / Package Type	Kutu / Pack
Adet / m / Quantity / m	5
Ağırlık / Weight	9,39 kg
m <sup>3</sup> / Volume	0,07306

## COMFORT W OTOMAT ZAYIF AKIM KUTULARI (METAL)

### METAL COMFORT MCB LOW CURRENT BOX



001 058 000012 00 00 **12'li Sıva Altı Metal Tabanlı + Plastik Kapaklı Otomatik Sigorta Kutusu**  
Distribution Box - 12 Modules Metal Base + Plastic Cover Flush Type

001 058 001012 00 00 **Sıva Altı Metal Tabanlı + Plastik Kapaklı Zayıf Akım Kutusu**  
Low Current Box Metal Base + Plastic Cover Flush Type

Ankastre Ölçüsü / Mounting Dimension	210 x 252 x 80 mm
Ürün Ölçüsü / Product Dimension	230 x 275 x 102 mm
Tekli Kutu Ölçüsü / Single Box Dimension	281 x 238 x 104 mm
Ağırlık / Weight	2,02 Kg.



001 058 000024 00 00 **24'lü Sıva Altı Metal Tabanlı + Plastik Kapaklı Otomatik Sigorta Kutusu**  
Distribution Box - 24 Modules Metal Base + Plastic Cover Flush Type

001 058 001024 00 00 **12 Sigortalı + Zayıf Akım Bölmeli Sıva Altı Metal Tabanlı + Plastik Kapaklı Kutu**  
Distribution Box 12 Modules + Low Current Box Metal Base + Plastic Cover Flush Type

001 058 502532 00 00 **250 x 320 mm Sıva Altı Metal Tabanlı + Plastik Kapaklı Zayıf Akım Kutusu**  
Low Current Box 250 x320mm Metal Base + Plastic Cover Flush Type

Ankastre Ölçüsü / Mounting Dimension	255 x 324 x 80 mm
Ürün Ölçüsü / Product Dimension	275 x 345 x 102 mm
Tekli Kutu Ölçüsü / Single Box Dimension	350 x 283 x 104 mm
Ağırlık / Weight	2,95 Kg.



001 058 000036 00 00 **36'lı Sıva Altı Metal Tabanlı + Plastik Kapaklı Otomatik Sigorta Kutusu**  
Distribution Box - 36 Modules Metal Base + Plastic Cover Flush Type

001 058 001036 00 00 **24 Sigortalı + Zayıf Akım Bölmeli Sıva Altı Metal Tabanlı + Plastik Kapaklı Kutu**  
Distribution Box 24 Modules + Low Current Box Metal Base + Plastic Cover Flush Type

Ankastre Ölçüsü / Mounting Dimension	255 x 440 x 80 mm
Ürün Ölçüsü / Product Dimension	275 x 46 x 102 mm
Tekli Kutu Ölçüsü / Single Box Dimension	465 x 282 x 105 mm
Ağırlık / Weight	3,85 Kg.



001 058 602532 00 00 **250 mm x 320 mm Sıva Altı Zayıf Akım Kutusu**  
Metal Low Current Box 250 mm x 320 mm Flush Type

Ankastre Ölçüsü / Mounting Dimension	250 x 320 x 73 mm
Ambalaj Ölçüsü / Box Dimension	460 x 300 x 110 mm
Ağırlık / Weight	3.70 Kg.

## COMFORT W OTOMAT ZAYIF AKIM KUTULARI (METAL) METAL COMFORT MCB LOW CURRENT BOX



001 058 602544 00 00 **250 mm x 440 mm Metal Sıva Altı Zayıf Akım Kutusu**  
Metal Low Current Box 250 mm x 440 mm Flush Type

Ankastre Ölçüsü / Mounting Dimension	250 x 440 x 73 mm
Ambalaj Ölçüsü / Box Dimension	570 x 300 x 110 mm
Ağırlık / Weight	4,70 Kg.



001 058 604040 00 00 **400 x 400 mm Sıva Altı Metal Zayıf Akım Kutusu**  
Metal Low Current Box 400 x 400 mm Flush Type

Ankastre Ölçüsü / Mounting Dimension	400 x 400 x 73 mm
Ambalaj Ölçüsü / Box Dimension	520 x 520 x 110 mm
Ağırlık / Weight	6.50 Kg.



001 058 400036 00 00 **24 Sigortalı + Zayıf Akım Bölmeli Sıva Altı Metal Kutu**  
Metal Distribution Box 24 Modules + Low Current Box Flush Type

Ankastre Ölçüsü / Mounting Dimension	700 x 300 x 80 mm
Ambalaj Ölçüsü / Box Dimension	730 x 330 x 110 mm
Ağırlık / Weight	9,50 Kg.



001 058 400048 00 00 **36 Sigortalı + Zayıf Akım Bölmeli Sıva Altı Metal Kutu**  
Metal Distribution Box 36 Modules + Low Current Box Flush Type

Ankastre Ölçüsü / Mounting Dimension	730 x 450 x 80 mm
Ambalaj Ölçüsü / Box Dimension	780 x 500 x 110 mm
Ağırlık / Weight	11,90 Kg.

# MEKSBOX

## W Otomat kutuları

### Fuse boxes



#### ÖLÇÜLER (mm) DIMENSIONS

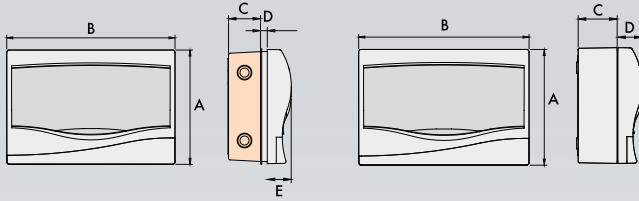

#### SIVAALTI W OTOMAT KUTULARI FLUSH MOUNTED FUSE BOXES

	A	B	C	D	E
2'li	142	93	53.5	11,5	40
4'lü	142	138	53.5	11,5	40
6'lı	142	163	53.5	11,5	40
9'lu	172	217	53.5	11,5	40
12'li	182	272	53.5	11,5	40
16'lı	272	207	53.5	11,5	40
24'lü	332	272	53.5	11,5	40
36'lı	482	272	53.5	11,5	40

#### SIVAÜSTÜ W OTOMAT KUTULARI SURFACE MOUNTED FUSE BOXES

	A	B	C	D
2'li	149	100	65	40
4'lü	150	150	65	40
6'lı	150	170	65	40
9'lu	180	225	65	40
12'li	190	280	65	40
16'lı	290	215	65	40
24'lü	340	280	65	40
36'lı	490	280	65	40

<b>Terminal koruma seviyesi (Koruma sınıfı)</b> Terminal protection level (Protection class)	<b>IP 30</b> IP 30
<b>Kutuların tipi</b> Type of boxes	<b>Dikdörtgen kutulardır.</b> Rectangular box
<b>Tesis sırasındaki sıcaklık aralığı</b> Temperature range during installation	<b>-25°C / +60°C</b> -25°C / +60°C
<b>Yalıtım direnci</b> Insulation resistance	<b>5 MΩ'un üzerindedir.</b> Over 5 m Ohm
<b>Yüksek gerilime dayanımı</b> Resistance to high voltage	<b>3750 V AC (Alternatif akım, 220 / 400 V-50 Hz)</b> 3750 V AC [Alternating Current, 220/400 V-50 Hz]

#### TESİS VE UYGULAMA

Sağlam, yanmaz duvarda ve tavanda kullanıma uygundur. İnşaat sırasında ve inşaat işleminden sonra montaja elverişlidir.

Sert, yanabilir duvarlarda ve tavanda kullanıma uygundur.

Beton içerisi hariç tüm montaj tipleri için uygundur.

Kutuların sivaüstü ve sivaaltı tespiti son derece kolay yapılabilecek şekilde tasarlanmıştır.

Kutular elektriksel korumayı sağlayacak şekilde tasarlanmıştır.

Kutuların giriş delikleri boru girişine uygundur.

Kutuların normal kullanım sürecinde oluşabilecek yaşlanma ve nemli şartlara karşı dayanıklılığı, kullanılan metal malzemelerin paslanmaya karşı dayanıklılığı, sızdırmazlık ve aşınma testleri ve elektrik çarpmasına karşı koruma testleri, ısıya dayanıklılık testleri, mekanik dayanıklılık testleri ve olağan dışı ısıya karşı dayanıklılık testleri TS EN 60670-1/ARALIK 2015 standard kapsamında yapılan yeterlilik testleri ile doğrulanmıştır.

#### INSTALLATION AND APPLICATION

Fuse boxes are suitable for use on sound and fireproof walls and ceilings. The fuse boxes are suitable for installation during and after construction works.

Suitable for application on solid and combustible walls and ceilings.

Suitable for all installation types except for concrete-embedded applications.

The fuse boxes are designed for easy flush-mounted and surface mounted installation.

Fuse boxes are designed to provide electrical protection.

Inlet ports of the fuse boxes are compatible for pipe installation.

The resistance of the fuse boxes against ageing and humidity conditions that might occur during normal use, resistance of the metals used against oxidation are validated by means of permeability and abrasion tests, tests for resistance to temperature, mechanical endurance tests and extraordinary heat resistance tests conducted under the scope of TS EN 60670-1/DECEMBER 2005 standard

## SIVA ÜSTÜ W OTOMAT KUTULARI

SURFACE MOUNTED FUSE BOXES

IP 30

## SIVA ALTI W OTOMAT KUTULARI

FLUSH MOUNTED FUSE BOXES

IP 30



001 027 110002 00 00 Alev Yaymayan  
Non Flammable

001 027 100002 00 00 Alev Yayan  
Flammable



### 1-2 'li Siva Üstü W Otomat Kutusu

Surface-Mounted Fuse Box , 1-2 Fuse

Ambalaj Şekli / Package Type	Kutu / Pack
Adet / m / Quantity / m	30
Ağırlık / Weight	9,933 / 9,459 kg
m <sup>3</sup> / Volume	0,05700



001 027 010002 00 00 Alev Yaymayan  
Non Flammable

001 027 000002 00 00 Alev Yayan  
Flammable



### 1-2 'li Siva Altı W Otomat Kutusu

Flush-Mounted Fuse Box , 1-2 Fuse

Ambalaj Şekli / Package Type	Kutu / Pack
Adet / m / Quantity / m	30
Ağırlık / Weight	9,398 / 8,949 kg
m <sup>3</sup> / Volume	0,05700



001 027 110004 00 00 Alev Yaymayan  
Non Flammable

001 027 100004 00 00 Alev Yayan  
Flammable



### 3-4 'lü Siva Üstü W Otomat Kutusu

Surface-Mounted Fuse Box , 3-4 Fuse

Ambalaj Şekli / Package Type	Kutu / Pack
Adet / m / Quantity / m	20
Ağırlık / Weight	8,274 / 7,880 kg
m <sup>3</sup> / Volume	0,05400



001 027 010004 00 00 Alev Yaymayan  
Non Flammable

001 027 000004 00 00 Alev Yayan  
Flammable



### 3-4 'lü Siva Altı W Otomat Kutusu

Flush-Mounted Fuse Box , 3-4 Fuse

Ambalaj Şekli / Package Type	Kutu / Pack
Adet / m / Quantity / m	20
Ağırlık / Weight	7,880 / 7,506 kg
m <sup>3</sup> / Volume	0,05400



001 027 110006 00 00 Alev Yaymayan  
Non Flammable

001 027 100006 00 00 Alev Yayan  
Flammable



### 2-6 'lı Siva Üstü W Otomat Kutusu

Surface-Mounted Fuse Box , 2-6 Fuse

Ambalaj Şekli / Package Type	Kutu / Pack
Adet / m / Quantity / m	20
Ağırlık / Weight	10,143 / 9,660 kg
m <sup>3</sup> / Volume	0,06400



001 027 010006 00 00 Alev Yaymayan  
Non Flammable

001 027 000006 00 00 Alev Yayan  
Flammable



### 2-6 'lı Siva Altı W Otomat Kutusu

Flush-Mounted Fuse Box , 2-6 Fuse

Ambalaj Şekli / Package Type	Kutu / Pack
Adet / m / Quantity / m	20
Ağırlık / Weight	9,550 / 9,096 kg
m <sup>3</sup> / Volume	0,06400



001 027 110009 00 00 Alev Yaymayan  
Non Flammable

001 027 100009 00 00 Alev Yayan  
Flammable



### 9 'lu Siva Üstü W Otomat Kutusu

Surface-Mounted Fuse Box , 9 Fuse

Ambalaj Şekli / Package Type	Kutu / Pack
Adet / m / Quantity / m	20
Ağırlık / Weight	14,065 / 13,396 kg
m <sup>3</sup> / Volume	0,10000



001 027 010009 00 00 Alev Yaymayan  
Non Flammable

001 027 000009 00 00 Alev Yayan  
Flammable



### 9 'lu Siva Altı W Otomat Kutusu

Flush-Mounted Fuse Box , 9 Fuse

Ambalaj Şekli / Package Type	Kutu / Pack
Adet / m / Quantity / m	20
Ağırlık / Weight	13,582 / 12,936 kg
m <sup>3</sup> / Volume	0,10000



**SIVA ÜSTÜ W OTOMAT KUTULARI**  
SURFACE MOUNTED FUSE BOXES

IP 30



001 027 110012 00 00

Alev Yaymayan  
Non Flammable

001 027 100012 00 00

Alev Yayan  
Flammable**12 'li Sıva Üstü W Otomat Kutusu**  
Surface-Mounted Fuse Box , 12 Fuse

Ambalaj Şekli / Package Type	Kutu / Pack
Adet / m / Quantity / m	10
Ağırlık / Weight	8,400 / 8,290 kg
m <sup>3</sup> / Volume	0,06400

**SIVA ALTI W OTOMAT KUTULARI**  
FLUSH MOUNTED FUSE BOXES

IP 30



001 027 010012 00 00

Alev Yaymayan  
Non Flammable

001 027 000012 00 00

Alev Yayan  
Flammable**12 'li Sıva Altı W Otomat Kutusu**  
Flush-Mounted Fuse Box , 12 Fuse

Ambalaj Şekli / Package Type	Kutu / Pack
Adet / m / Quantity / m	10
Ağırlık / Weight	8,850 / 8,380 kg
m <sup>3</sup> / Volume	0,06400



001 027 110016 00 00

Alev Yaymayan  
Non Flammable

001 027 100016 00 00

Alev Yayan  
Flammable**16 'lı Sıva Üstü W Otomat Kutusu**  
Surface-Mounted Fuse Box , 16 Fuse

Ambalaj Şekli / Package Type	Kutu / Pack
Adet / m / Quantity / m	10
Ağırlık / Weight	11,015 / 10,490 kg
m <sup>3</sup> / Volume	0,07300



001 027 010016 00 00

Alev Yaymayan  
Non Flammable

001 027 000016 00 00

Alev Yayan  
Flammable**16 'lı Sıva Altı W Otomat Kutusu**  
Flush-Mounted Fuse Box , 16 Fuse

Ambalaj Şekli / Package Type	Kutu / Pack
Adet / m / Quantity / m	10
Ağırlık / Weight	10,238 / 9,750 kg
m <sup>3</sup> / Volume	0,07300



001 027 110024 00 00

Alev Yaymayan  
Non Flammable

001 027 100024 00 00

Alev Yayan  
Flammable**24 'lü Sıva Üstü W Otomat Kutusu**  
Surface-Mounted Fuse Box , 24 Fuse

Ambalaj Şekli / Package Type	Kutu / Pack
Adet / m / Quantity / m	5
Ağırlık / Weight	7,697 / 7,330 kg
m <sup>3</sup> / Volume	0,05700



001 027 010024 00 00

Alev Yaymayan  
Non Flammable

001 027 000024 00 00

Alev Yayan  
Flammable**24 'lü Sıva Altı W Otomat Kutusu**  
Flush-Mounted Fuse Box , 24 Fuse

Ambalaj Şekli / Package Type	Kutu / Pack
Adet / m / Quantity / m	5
Ağırlık / Weight	7,534 / 7,175 kg
m <sup>3</sup> / Volume	0,05700

## SIVA ÜSTÜ W OTOMAT KUTULARI

SURFACE MOUNTED FUSE BOXES

IP 30

## SIVA ALTI W OTOMAT KUTULARI

FLUSH MOUNTED FUSE BOXES

IP 30



001 027 110036 00 00

Alev Yaymayan  
Non Flammable

001 027 100036 00 00

Alev Yayan  
Flammable



**36 'li Siva Üstü W Otomat Kutusu**  
Surface-Mounted Fuse Box , 36 Fuse

Ambalaj Şekli / Package Type	Kutu / Pack
Adet / m / Quantity / m	5
Ağırlık / Weight	10,720 / 10,105 kg
m <sup>3</sup> / Volume	0,07595



001 027 010036 00 00

Alev Yaymayan  
Non Flammable

001 027 000036 00 00

Alev Yayan  
Flammable



**36 'li Siva Altı W Otomat Kutusu**  
Flush-Mounted Fuse Box , 36 Fuse

Ambalaj Şekli / Package Type	Kutu / Pack
Adet / m / Quantity / m	5
Ağırlık / Weight	10,835 / 10,200 kg
m <sup>3</sup> / Volume	0,07595

## MEKS SERİSİ MÜHÜRLÜ SİGORTA KUTULARI

MEKS SERIES SEALED FUSE BOXES

IP 30



**1 'li Siva Üstü Mühürlü Sigorta Kutusu**

Surface Mounted Sealed  
Fuse Box , 1 Fuse

001 027 210001 00 00

Alev Yaymayan  
Non Flammable

001 027 200001 00 00

Alev Yayan  
Flammable

Ambalaj Şekli / Package Type	Kutu / Pack
Adet / m / Quantity / m	160
Ağırlık / Weight	10,208 / 9,728 kg
m <sup>3</sup> / Volume	0,08000



**1-2 'li Siva Üstü Mühürlü Sigorta Kutusu**

Surface Mounted Sealed  
Fuse Box , 1-2 Fuse

001 027 210002 00 00

Alev Yaymayan  
Non Flammable

001 027 200002 00 00

Alev Yayan  
Flammable

Ambalaj Şekli / Package Type	Kutu / Pack
Adet / m / Quantity / m	80
Ağırlık / Weight	6,500 / 6,192 kg
m <sup>3</sup> / Volume	0,04800



**3-4 'li Siva Üstü Mühürlü Sigorta Kutusu**

Surface Mounted Sealed  
Fuse Box , 3-4 Fuse

001 027 210004 00 00

Alev Yaymayan  
Non Flammable

001 027 200004 00 00

Alev Yayan  
Flammable

Ambalaj Şekli / Package Type	Kutu / Pack
Adet / m / Quantity / m	80
Ağırlık / Weight	8,936 / 8,512 kg
m <sup>3</sup> / Volume	0,08800



## TELEFON DAĞITIM KUTULARI VE AKSESUARLARI

### TELEPHONE DISTRIBUTION BOXES (HUBS) and ACCESSORIES

	Kod Code	Açıklama Description	Ambalaj Packing	Adet Quantity	Ağırlık Weight	Hacim Volume
 <p>IP 40</p>	Alev Yayımayan Non Flammable    <b>001 049 201020 00 00</b>	<b>Telefon Dağıtım Kutusu 10-20 (Plastik Kilitli)</b> Telephone Distribution Box, 10-20 Hubs (With Plastic Lock)	Kutu Pack	60	20,502 Kg	0,13709
	Alev Yayan Flammable <b>001 049 001020 00 00</b>					
 <p>IP 40</p>	Alev Yayımayan Non Flammable    <b>001 049 211020 00 00</b>	<b>Telefon Dağıtım Kutusu 10-20 (Kilitli)</b> Telephone Distribution Box, 10-20 Hubs (With Lock)	Kutu Pack	60	21,198 Kg	0,13709
	Alev Yayan Flammable <b>001 049 011020 00 00</b>					
 <p>IP 40</p>	Alev Yayımayan Non Flammable    <b>001 049 201050 00 00</b>	<b>Telefon Dağıtım Kutusu 10-50 (Plastik Kilitli)</b> Telephone Distribution Box, 10-50 Hubs (With Plastic Lock)	Kutu Pack	28	18,029 Kg	0,13709
	Alev Yayan Flammable <b>001 049 001050 00 00</b>					
 <p>IP 40</p>	Alev Yayımayan Non Flammable    <b>001 049 211050 00 00</b>	<b>Telefon Dağıtım Kutusu 10-50 (Kilitli)</b> Telephone Distribution Box, 10-50 Hubs (With Lock)	Kutu Pack	28	18,620 Kg	0,13709
	Alev Yayan Flammable <b>001 049 011050 00 00</b>					
	<b>888 049 050002</b>	<b>Telefon Dağıtım Modülü (Kesmeli)</b> Telephone Distribution Module (With interrupt feature)	Kutu Pack	400	23,200 Kg	0,06200
	<b>888 049 050001</b>	<b>Telefon Dağıtım Modülü (Kesmesiz)</b> 10 Pairs Connection Module	Kutu Pack	400	23,200 Kg	0,06200
	<b>888 049 050003</b>	<b>İrtibatlama Aleti</b> Connection Tool	Kutu Pack	100	10,500 Kg	0,03480

## TELEFON DAĞITIM KUTULARI VE AKSESUARLARI

### TELEPHONE DISTRIBUTION BOXES (HUBS) and ACCESSORIES

	Kod Code	Açıklama Description	Ambalaj Packing	Adet Quantity	Ağırlık Weight	Hacim Volume
	888 049 050032	<b>Data Konnektörü Cat 6e (RJ 45) (8 Kontak Tolles)</b> Data Connector Cat 6e (RJ 45) (8 Contacts)	Kutu Pack	600	8,94 Kg	0,06000
	888 049 050009	<b>Telefon Konnektörü (RJ 11/12) (6 Kontak)</b> Telephone Connector (RJ 11/12) (8 Contacts)	Kutu Pack	200	1,34 Kg	0,00560

## MODÜL BAĞLANTI ÇATISI

### MODULE CONNECTION RACK

	Kod Code	Açıklama Description	Ambalaj Packing	Adet Quantity	Ağırlık Weight	Hacim Volume
	001 024 000001 00 00	<b>1 modül için</b> Rack for 1 module	Kutu Pack	1000	25 Kg	0,05100
	001 024 000002 00 00	<b>2 modül için</b> Rack for 2 modules	Kutu Pack	500	24 Kg	0,05100
	001 024 000003 00 00	<b>3 modül için</b> Rack for 3 modules	Kutu Pack	400	27,6 Kg	0,05120
	001 024 000004 00 00	<b>4 modül için</b> Rack for 4 modules	Kutu Pack	300	28,5 Kg	0,05130
	001 024 000005 00 00	<b>5 modül için</b> Rack for 5 modules	Kutu Pack	200	22,94 Kg	0,05120
	001 024 000010 00 00	<b>10 modül için</b> Rack for 10 modules	Kutu Pack	100	22,7 Kg	0,08600

**Çelik spiral,  
spiral ve borular**  
Steel spirals  
spirals and pipes



	<b>H.FREE ALEV YAYMAYAN SİRALLER</b> H.FREE NON - FLAMMABLE SPIRAL	<b>H.FREE ALEV YAYAN SİRALLER</b> H.FREE FLAMMABLE SPIRALS
<b>Boru tipi</b> Type of the Pipe	<b>Metalik olmayan - oluklu</b> Non-metallic - Corrugated	<b>Metalik olmayan - oluklu</b> Non-metallic - Corrugated
<b>Bağlantı metodu</b> Connection method	<b>Dış çekilmemiş</b> Non-threaded	<b>Dış çekilmemiş</b> Non-threaded
<b>Sıkıştırmaya karşı dayanıklılık</b> Compressive Strength	<b>Hafif (320 N) Orta (750 N) Ağır (1250 N)</b> Low (320 N) Medium (750 N) Heavy (1250 N)	<b>Hafif (320 N) Orta (750 N) Ağır (1250 N)</b> Low (320 N) Medium (750 N) Heavy (1250 N)
<b>Darbeye karşı dayanıklılık</b> Impact Resistance	<b>Orta (2 kg, 100 mm) -15°C'de</b> Medium (2 kg, 100 mm) - 15°C	<b>Orta (2 kg, 100 mm) -15°C'de</b> Medium (2 kg, 100 mm) - 15°C
<b>En küçük sürekli uygulama ve tesisat sıcaklığı</b> Minimum continuous application and installation temperature	<b>-15°C</b> -15°C	<b>-15°C</b> -15°C
<b>En büyük sürekli uygulama ve tesisat sıcaklığı</b> Maximum continuous application and installation temperature	<b>+60°C</b> +60°C	<b>+60°C</b> +60°C
<b>Bükülmeye karşı dayanıklılık</b> Flexural Strength	<b>Esnek - kendini toparlayan</b> Flexible-Self recovering	<b>Esnek - kendini toparlayan</b> Flexible-Self recovering
<b>Dış etkenlere karşı dayanıklılık</b> Resistance to external impacts	<b>Katı yabancı cisimlerin girişine karşı korumalı</b> Protected against ingress of solid foreign materials	<b>Katı yabancı cisimlerin girişine karşı korumalı</b> Protected against ingress of solid foreign materials
<b>Alev yayılmasına karşı dayanıklılık</b> Resistance to flame propagation	<b>Alev yaymayan</b> Non-Flammable	<b>Alev yayan</b> Flammable

#### **POLYAMİD (PA) ALEV YAYMAYAN SİRALLER** POLYAMIDE (PA) NON-FLAME-PROPAGATING SPIRALS

<b>Boru tipi</b> Type of the Pipe	<b>Metalik olmayan - oluklu</b> Non-metallic - Corrugated
<b>Bağlantı metodu</b> Connection method	<b>Dış çekilmemiş</b> Non-threaded
<b>Sıkıştırmaya karşı dayanıklılık</b> Compressive Strength	<b>Hafif (320 N)</b> Low (320 N)
<b>Darbeye karşı dayanıklılık</b> Impact Resistance	<b>Hafif (1kg, 100 mm) -15°C'de</b> Low (1 kg, 100 mm) - 15°C
<b>En küçük sürekli uygulama ve tesisat sıcaklığı</b> Minimum continuous application and installation temperature	<b>-15°C</b> -15°C
<b>En büyük sürekli uygulama ve tesisat sıcaklığı</b> Maximum continuous application and installation temperature	<b>+105°C</b> +105°C
<b>Bükülmeye karşı dayanıklılık</b> Flexural Strength	<b>Esnek - kendini toparlayan</b> Flexible-Self recovering
<b>Dış etkenlere karşı dayanıklılık</b> Resistance to external impacts	<b>Katı yabancı cisimlerin girişine karşı korumalı</b> Protected against ingress of solid foreign materials
<b>Alev yayılmasına karşı dayanıklılık</b> Resistance to flame propagation	<b>Alev yaymayan</b> Non-Flammable

#### **POLİPROPİLEN (PP) SİRALLER** POLYPROPYLENE (PP) FLAMMABLE SPIRALS

<b>Boru tipi</b> Type of the Pipe	<b>Metalik olmayan - oluklu</b> Non-metallic - Corrugated
<b>Bağlantı metodu</b> Connection method	<b>Dış çekilmemiş</b> Non-threaded
<b>Sıkıştırmaya karşı dayanıklılık</b> Compressive Strength	<b>Hafif (320 N)</b> Low (320 N)
<b>Darbeye karşı dayanıklılık</b> Impact Resistance	<b>Hafif (1kg, 100 mm) -15°C'de</b> Low (1 kg, 100 mm) - 15°C
<b>En küçük sürekli uygulama ve tesisat sıcaklığı</b> Minimum continuous application and installation temperature	<b>-15°C</b> -15°C
<b>En büyük sürekli uygulama ve tesisat sıcaklığı</b> Maximum continuous application and installation temperature	<b>+90°C</b> +90°C
<b>Bükülmeye karşı dayanıklılık</b> Flexural Strength	<b>Esnek - kendini toparlayan</b> Flexible-Self recovering
<b>Dış etkenlere karşı dayanıklılık</b> Resistance to external impacts	<b>Katı yabancı cisimlerin girişine karşı korumalı</b> Protected against ingress of solid foreign materials
<b>Alev yayılmasına karşı dayanıklılık</b> Resistance to flame propagation	<b>Alev Yayan</b> Flammable

**RİJİT BORULAR RIGID PIPES**

<b>Boru tipi</b> Type of the Pipe	<b>Metalik olmayan</b> Non-metallic - Corrugated
<b>Bağlantı metodu</b> Connection method	<b>Diş çekilmemiş</b> Non-threaded
<b>Sıkıştırma karşı dayanıklılık</b> Compressive Strength	<b>H.FREE RİJİT BORULAR</b> Hafif (320 N) Orta (750 N) Ağır (1250 N) <b>RİJİT BORULAR</b> Orta (750 N) <b>H.FREE RIGID PIPES</b> Low (320 N) Medium (750 N) Heavy (1250 N) <b>RIGID PIPES</b> Medium (750 N)
<b>Darbeye karşı dayanıklılık</b> Impact Resistance	<b>Orta (2 Kg, 100 mm) -15°C'de</b> Medium (2 Kg, 100 mm) - 15°C
<b>En küçük sürekli uygulama ve tesisat sıcaklığı</b> Minimum continuous application and installation temperature	<b>-15°C</b> -15°C
<b>En büyük sürekli uygulama ve tesisat sıcaklığı</b> Maximum continuous application and installation temperature	<b>+60°C</b> +60°C
<b>Bükülmeye karşı dayanıklılık</b> Flexural Strength	<b>Rijit</b> Rigid
<b>Dış etkenlere karşı dayanıklılık</b> Resistance to external impacts	<b>Katı yabancı cisimlerin girişine karşı korumalı</b> Protected against ingress of solid foreign materials
<b>Alev yayılmasına karşı dayanıklılık</b> Resistance to flame propagation	<b>Alev yaymayan borular</b> Non-Flammable

**H.FREE ALEV YAYAN DÜZ ELEKTRİK TESİSAT BORULARI H.FREE FLAME PLAIN ELECTRICAL INSTALLATION PIPE**

<b>Boru tipi</b> Type of the Pipe	<b>Metalik olmayan</b> Non-metallic
<b>Bağlantı metodu</b> Connection method	<b>Diş çekilmemiş</b> Non-threaded
<b>Sıkıştırma karşı dayanıklılık</b> Compressive Strength	<b>SİBOR SERİSİ</b> Çok Hafif (125 N) Hafif (320 N) <b>MEKS SERİSİ</b> Hafif (320 N) Orta (750 N) Ağır (1250 N) <b>SİBOR SERIES</b> Very Low (125 N) Low (320 N) <b>MEKS SERIES</b> Low (320 N) Medium (750 N) Heavy (1250 N)
<b>Darbeye karşı dayanıklılık</b> Impact Resistance	<b>Orta (2 Kg, 100 mm) -15°C'de</b> Medium (2 Kg, 100 mm) - 15°C
<b>En küçük sürekli uygulama ve tesisat sıcaklığı</b> Minimum continuous application and installation temperature	<b>-15°C</b> -15°C
<b>En büyük sürekli uygulama ve tesisat sıcaklığı</b> Maximum continuous application and installation temperature	<b>+60°C</b> +60°C
<b>Bükülmeye karşı dayanıklılık</b> Flexural Strength	<b>Esnek - kendini toparlayan</b> Flexible-Self recovering
<b>Dış etkenlere karşı dayanıklılık</b> Resistance to external impacts	<b>Katı yabancı cisimlerin girişine karşı korumalı</b> Protected against ingress of solid foreign materials
<b>Alev yayılmasına karşı dayanıklılık</b> Resistance to flame propagation	<b>Alev yayan</b> Flammable

**H.FREE ALEV YAYMAYAN DÜZ ELEKTRİK TESİSAT BORULARI H.FREE NON-FLAME PLAIN ELECTRICAL INSTALLATION PIPE**

<b>Boru tipi</b> Type	<b>Metalik olmayan</b> Non-metallic
<b>Bağlantı metodu</b> Connection type	<b>Diş çekilmemiş</b> Non-threaded
<b>Sıkıştırma karşı dayanıklılık</b> External load resistance	<b>SİBOR SERİSİ</b> Çok Hafif (125 N) Hafif (320 N) <b>MEKS SERİSİ</b> Hafif (320 N) Orta (750 N) Ağır (1250 N) <b>SİBOR SERIES</b> Very Low (125 N) Low (320 N) <b>MEKS SERIES</b> Low (320 N) Medium (750 N) Heavy (1250 N)
<b>Darbeye karşı dayanıklılık</b> Impact resistance	<b>Orta (2 Kg, 100 mm) -15°C'de</b> Medium (2 Kg, 100 mm) - 15°C
<b>En küçük sürekli uygulama ve tesisat sıcaklığı</b> Starting and installation temperature minimum	<b>-15°C</b> -15°C
<b>En büyük sürekli uygulama ve tesisat sıcaklığı</b> Starting and installation temperature maximum	<b>+60°C</b> +60°C
<b>Bükülmeye karşı dayanıklılık</b> Resistance for stiffness	<b>Esnek - kendini toparlayan</b> Flexible-Self recovering
<b>Dış etkenlere karşı dayanıklılık</b> Resistance to external materials	<b>Katı yabancı cisimlerin girişine karşı korumalı</b> Protected against ingress of solid foreign materials
<b>Alev yayılmasına karşı dayanıklılık</b> Resistance to fire	<b>Alev yaymayan</b> Non-Flammable

**ÇELİK SİRİAL EKO / MEKS STEEL SPIRALS EKO / MEKS**

<b>Boru tipi</b> Type of the Pipe	<b>Metalik - Oluklu</b> Non-metallic - Corrugated
<b>Baęlantı metodu</b> Connection method	<b>Diş çekilmemiş</b> Non-threaded
<b>Sıkıřtırmaya karşı dayanıklılık</b> Compressive Strength	<b>Hafif (320 N)</b> Low (320 N)
<b>Darbeye karşı dayanıklılık</b> Impact Resistance	<b>Hafif (1kg, 100 mm)</b> Low (1 kg, 100 mm)
<b>En küçük sürekli uygulama ve tesisat sıcaklığı</b> Minimum continuous application and installation temperature	<b>-15°C</b> -15°C
<b>En büyük sürekli uygulama ve tesisat sıcaklığı</b> Maximum continuous application and installation temperature	<b>+60</b> +60
<b>Bükülmeye karşı dayanıklılık</b> Flexural Strength	<b>Esnek</b> Flexible
<b>Diş etkenlere karşı dayanıklılık</b> Resistance to external impacts	<b>Katı yabancı cisimlerin girişine karşı korumalı</b> Protected against ingress of solid foreign materials
<b>Alev yayılmasına karşı dayanıklılık</b> Resistance to flame propagation	<b>Alev yaymayan</b> Non-Flammable

**İZOLELİ ÇELİK SİRİAL EKO / MEKS INSULATED STEEL SPIRALS EKO / MEKS**

<b>Boru tipi</b> Type of the Pipe	<b>Kompozit - Oluklu</b> Composite - Corrugated
<b>Baęlantı metodu</b> Connection method	<b>Diş çekilmemiş</b> Non-threaded
<b>Sıkıřtırmaya karşı dayanıklılık</b> Compressive Strength	<b>Hafif (320 N)</b> Low (320 N)
<b>Darbeye karşı dayanıklılık</b> Impact Resistance	<b>Hafif (1kg, 100 mm)</b> Low (1 kg, 100 mm)
<b>En küçük sürekli uygulama ve tesisat sıcaklığı</b> Minimum continuous application and installation temperature	<b>-15°C</b> -15°C
<b>En büyük sürekli uygulama ve tesisat sıcaklığı</b> Maximum continuous application and installation temperature	<b>+60</b> +60
<b>Bükülmeye karşı dayanıklılık</b> Flexural Strength	<b>Esnek</b> Flexible
<b>Diş etkenlere karşı dayanıklılık</b> Resistance to external impacts	<b>Katı yabancı cisimlerin girişine karşı korumalı</b> Protected against ingress of solid foreign materials
<b>Alev yayılmasına karşı dayanıklılık</b> Resistance to flame propagation	<b>Alev yaymayan</b> Non-Flammable













**PVC ALEV YAYMAYAN SİRİAL PVC SPIRALS FLAME - PROPAGATING**

<b>Boru tipi</b> Type of the Pipe	<b>Metalik olmayan - Oluklu</b> Non-metallic - Corrugated
<b>Baęlantı metodu</b> Connection method	<b>Diş çekilmemiş</b> Non-threaded
<b>Sıkıřtırmaya karşı dayanıklılık</b> Compressive Strength	<b>Hafif (320 N) Orta (750 N)</b> Low (320 N) Medium (750 N)
<b>Darbeye karşı dayanıklılık</b> Impact Resistance	<b>Orta (2 kg / 100 mm)</b> Medium (2 kg / 100 mm)
<b>En küçük sürekli uygulama ve tesisat sıcaklığı</b> Minimum continuous application and installation temperature	<b>-15°C</b> -15°C
<b>En büyük sürekli uygulama ve tesisat sıcaklığı</b> Maximum continuous application and installation temperature	<b>+60</b> +60
<b>Bükülmeye karşı dayanıklılık</b> Flexural Strength	<b>Esnek</b> Flexible
<b>Diş etkenlere karşı dayanıklılık</b> Resistance to external impacts	<b>Katı yabancı cisimlerin girişine karşı korumalı</b> Protected against ingress of solid foreign materials
<b>Alev yayılmasına karşı dayanıklılık</b> Resistance to flame propagation	<b>Alev yaymayan</b> Non-Flammable



## ÇELİK SİRALLER

### STEEL SPIRALS

	Kod Code	İç Çap Inner Diameter	Dış Çap Outer Diameter	Kod Code	İç Çap Inner Diameter	Dış Çap Outer Diameter
<b>EKO SERİSİ ÇELİK SİRALLER</b> ECO SERIES STEEL SPIRALS				<b>MEKS SERİSİ ÇELİK SİRALLER</b> MEKS SERIES STEEL SPIRALS		
 	001 054 150009 00 66	9 mm	12,10 mm	 001 054 120009 00 66	9 mm	12,10 mm
	001 054 150011 00 66	11 mm	14,10 mm	 001 054 120011 00 66	11 mm	14,10 mm
	001 054 150014 00 66	14 mm	17,10 mm	 001 054 120014 00 66	14 mm	17,10 mm
	001 054 150016 00 66	16 mm	19,10 mm	 001 054 120016 00 66	16 mm	19,10 mm
	001 054 150018 00 66	18 mm	21,10 mm	 001 054 120018 00 66	18 mm	21,10 mm
	001 054 150021 00 66	21 mm	24,10 mm	 001 054 120026 00 66	26 mm	29,10 mm
	001 054 150026 00 66	26 mm	29,10 mm	 001 054 120029 00 66	29 mm	32,10 mm
	001 054 150029 00 66	29 mm	32,10 mm	001 054 120032 00 66	32 mm	35,10 mm
	001 054 150032 00 66	32 mm	35,10 mm	 001 054 120037 00 66	37 mm	41,10 mm
	001 054 150037 00 66	37 mm	41,10 mm	 001 054 120042 00 66	42 mm	45,10 mm
	001 054 150042 00 66	42 mm	45,10 mm	 001 054 120050 00 66	50 mm	53,10 mm
	001 054 150050 00 66	50 mm	53,10 mm	001 054 120063 00 66	63 mm	66,10 mm

	Kod Code	İç Çap Inner Diameter	Dış Çap Outer Diameter	Kod Code	İç Çap Inner Diameter	Dış Çap Outer Diameter
<b>EKO SERİSİ ÇELİK SİRALLER İÇTEN TELLİ</b> ECO SERIES STEEL SPIRALS WITH INTERNAL WIRE				<b>MEKS SERİSİ SİRALLER İÇTEN TELLİ</b> MEKS SERIES STEEL SPIRALS WITH INTERNAL WIRE		
 	001 054 221009 00 66	9 mm	12,10 mm	001 054 121009 00 66	9 mm	12,10 mm
	001 054 221011 00 66	11 mm	14,10 mm	001 054 121011 00 66	11 mm	14,10 mm
	001 054 221014 00 66	14 mm	17,10 mm	001 054 121014 00 66	14 mm	17,10 mm
	001 054 221016 00 66	16 mm	19,10 mm	001 054 121016 00 66	16 mm	19,10 mm
	001 054 221018 00 66	18 mm	21,10 mm	001 054 121018 00 66	18 mm	21,10 mm
	001 054 221021 00 66	21 mm	24,10 mm	001 054 121026 00 66	26 mm	29,10 mm
	001 054 221026 00 66	26 mm	29,10 mm	001 054 121029 00 66	29 mm	32,10 mm
	001 054 221029 00 66	29 mm	32,10 mm	001 054 101032 00 66	32 mm	35,10 mm
	001 054 201032 00 66	32 mm	35,10 mm	001 054 121037 00 66	37 mm	41,10 mm
	001 054 221037 00 66	37 mm	41,10 mm	001 054 121042 00 66	42 mm	45,10 mm
	001 054 221042 00 66	42 mm	45,10 mm	001 054 121050 00 66	50 mm	53,10 mm
	001 054 221050 00 66	50 mm	53,10 mm	001 054 121063 00 66	63 mm	66,10 mm

## PVC İZOLELİ SPİRALLER

### PVC INSULATED SPIRALS

	Kod Code	İç Çap Inner Diameter	Dış Çap Outer Diameter	Kod Code	İç Çap Inner Diameter	Dış Çap Outer Diameter
<b>EKO SERİSİ İZOLELİ ÇELİK SPİRALLER</b> ECO SERIES INSULATED STEEL SPIRALS				<b>MEKS SERİSİ İZOLELİ ÇELİK SPİRALLER</b> MEKS SERIES ISOLATED STEEL SPIRALS		
	001 054 160009 00 11	9 mm	13,20 mm	001 054 130009 00 11	9 mm	13,20 mm
	001 054 160011 00 11	11 mm	15,20 mm	001 054 130011 00 11	11 mm	15,20 mm
	001 054 160014 00 11	14 mm	18,40 mm	001 054 130014 00 11	14 mm	18,40 mm
	001 054 160016 00 11	16 mm	20,40 mm	001 054 130016 00 11	16 mm	20,40 mm
	001 054 160018 00 11	18 mm	22,40 mm	001 054 130018 00 11	18 mm	22,40 mm
	001 054 160021 00 11	21 mm	25,40 mm	001 054 130026 00 11	26 mm	30,40 mm
	001 054 160026 00 11	26 mm	30,40 mm	001 054 130029 00 11	29 mm	33,40 mm
	001 054 160029 00 11	29 mm	33,40 mm	001 054 130032 00 11	32 mm	36,40 mm
	001 054 160032 00 11	32 mm	36,40 mm	001 054 130037 00 11	37 mm	42,40 mm
	001 054 160037 00 11	37 mm	42,40 mm	001 054 130042 00 11	42 mm	46,40 mm
	001 054 160042 00 11	42 mm	46,40 mm	001 054 130050 00 11	50 mm	54,40 mm
	001 054 160050 00 11	50 mm	54,40 mm	001 054 130063 00 11	63 mm	67,20 mm

CE IP40

## EKO SERİSİ İZOLELİ ÇELİK SPİRALLER İÇTEN TELLİ

### ECO SERIES INSULATED STEEL SPIRALS WITH INTERNAL WIRE

## MEKS SERİSİ İZOLELİ SPİRALLER İÇTEN TELLİ

### MEKS SERIES ISOLATED STEEL SPIRALS WITH INTERNAL WIRE

	001 054 231009 00 11	9 mm	13,20 mm	001 054 140009 00 11	9 mm	13,20 mm
	001 054 231011 00 11	11 mm	15,20 mm	001 054 140011 00 11	11 mm	15,20 mm
	001 054 231014 00 11	14 mm	18,40 mm	001 054 140014 00 11	14 mm	18,40 mm
	001 054 231016 00 11	16 mm	20,40 mm	001 054 140016 00 11	16 mm	20,40 mm
	001 054 131018 00 11	18 mm	22,40 mm	001 054 140018 00 11	18 mm	22,40 mm
	001 054 131021 00 11	21 mm	25,40 mm	001 054 140026 00 11	26 mm	30,40 mm
	001 054 131026 00 11	26 mm	30,40 mm	001 054 140029 00 11	29 mm	33,40 mm
	001 054 131029 00 11	29 mm	33,40 mm	001 054 140032 00 11	32 mm	36,40 mm
	001 054 131032 00 11	32 mm	36,40 mm	001 054 140037 00 11	37 mm	42,40 mm
	001 054 131037 00 11	37 mm	42,40 mm	001 054 140042 00 11	42 mm	46,40 mm
	001 054 131042 00 11	42 mm	46,40 mm	001 054 140050 00 11	50 mm	54,40 mm
	001 054 131050 00 11	50 mm	54,40 mm	001 054 100063 00 11	63 mm	67,20 mm

CE IP40



## PVC SİRALLER

### PVC SPIRALS

	Kod Code	İç Çap Inner Diameter	Dış Çap Outer Diameter
--	-------------	--------------------------	---------------------------

#### PVC ALEV YAYMAYAN SİRALLER (FLEXI MEKS) 750 N

#### PVC NON-FLAMMABLE SPIRALS (FLEXI MEKS) 750 N

 <p>IP30   </p>	001 020 000016 00 17	11,20 mm	15,85 mm
	001 020 000020 00 17	14,40 mm	19,85 mm
	001 020 000025 00 17	18,10 mm	24,80 mm
	001 020 000032 00 17	24,70 mm	31,80 mm



#### PVC ALEV YAYMAYAN KILAVUZ TELLİ SİRALLER (FLEXI MEKS) 750 N

#### PVC NON-FLAMMABLE SPIRALS WITH GUIDE WIRE (FLEXI MEKS) 750 N

 <p>IP30   </p>	001 020 100016 00 17	11,20 mm	15,85 mm
	001 020 100020 00 17	14,40 mm	19,85 mm
	001 020 100025 00 17	18,10 mm	24,80 mm
	001 020 100032 00 17	24,70 mm	31,80 mm

#### PVC ALEV YAYMAYAN SİRALLER (FLEXI MEKS) 320 N

#### PVC NON-FLAMMABLE SPIRALS (FLEXI MEKS) 320 N

 <p>IP30   </p>	001 020 010016 00 17	11,40 mm	15,85 mm
	001 020 010020 00 17	14,50 mm	19,85 mm
	001 020 010025 00 17	18,70 mm	24,80 mm
	001 020 010032 00 17	24,90 mm	31,80 mm

#### PVC ALEV YAYMAYAN KILAVUZ TELLİ SİRALLER (FLEXI MEKS) 320 N

#### PVC NON-FLAMMABLE SPIRALS WITH GUIDE WIRE (FLEXI MEKS) 320 N

 <p>IP30   </p>	001 020 120016 00 17	11,40 mm	15,85 mm
	001 020 120020 00 17	14,50 mm	19,85 mm
	001 020 120025 00 17	18,70 mm	24,80 mm
	001 020 120032 00 17	24,90 mm	31,80 mm

## HALOJEN FREE SPİRALLER 320 N

### HALOGEN-FREE SPIRALS 320 N

	Kod Code	İç Çap Inner Diameter	Dış Çap Outer Diameter
--	-------------	--------------------------	---------------------------

### HALOJEN FREE SPİRAL ALEV YAYAN 320 N

#### HALOGEN FREE SPIRALS FLAMMABLE 320N

 TSE CE HF	001 020 140016 00 12	11,20 mm	15,70 mm
	001 020 140020 00 12	14,40 mm	19,85 mm
	001 020 140025 00 12	19,10 mm	24,70 mm
	001 020 140032 00 12	24,85 mm	31,60 mm
	001 020 140040 00 12		
	001 020 140050 00 12		

### HALOJEN FREE SPİRAL ALEV YAYAN KILAVUZ TELLİ 320 N

#### HALOGEN FREE SPIRALS FLAMMABLE WITH GUIDE 320N

 TSE CE HF	001 020 141016 00 12	11,20 mm	15,70 mm
	001 020 141020 00 12	14,40 mm	19,85 mm
	001 020 141025 00 12	19,10 mm	24,70 mm
	001 020 141032 00 12	24,85 mm	31,60 mm
	001 020 141040 00 12		
	001 020 141050 00 12		

### HALOJEN FREE SPİRAL ALEV YAYMAYAN 320 N

#### HALOGEN FREE SPIRALS NON-FLAMMABLE 320N

 TSE CE HF	001 020 150016 00 17	11,20 mm	15,70 mm
	001 020 150020 00 17	14,40 mm	19,85 mm
	001 020 150025 00 17	19,10 mm	24,70 mm
	001 020 150032 00 17	24,85 mm	31,60 mm
	001 020 150040 00 17		
	001 020 150050 00 17		

### HALOJEN FREE SPİRAL ALEV YAYMAYAN KILAVUZ TELLİ 320 N

#### HALOGEN FREE SPIRALS NON-FLAMMABLE WITH GUIDE 320N

 TSE CE HF	001 020 151016 00 17	11,20 mm	15,70 mm
	001 020 151020 00 17	14,40 mm	19,85 mm
	001 020 151025 00 17	19,10 mm	24,70 mm
	001 020 151032 00 17	24,85 mm	31,60 mm
	001 020 151040 00 17		
	001 020 151050 00 17		

## HALOJEN FREE SİRALER 750 N

### HALOGEN-FREE SPIRALS 750 N

	Kod Code	İç Çap Inner Diameter	Dış Çap Outer Diameter
--	-------------	--------------------------	---------------------------

## HALOJEN FREE SİRAL ALEV YAYAN 750 N

### HALOGEN FREE SPIRALS FLAMMABLE 750N

  	001 020 740020 00 12	14,40 mm	19,85 mm
	001 020 740025 00 12	18,70 mm	24,70 mm
	001 020 740032 00 12	24,20 mm	31,60 mm

## HALOJEN FREE SİRAL ALEV YAYAN KILAVUZ TELLİ 750 N

### HALOGEN FREE SPIRALS FLAMMABLE WITH GUIDE WIRE 750N

  	001 020 741020 00 12	14,40 mm	19,85 mm
	001 020 741025 00 12	18,70 mm	24,70 mm
	001 020 741032 00 12	24,20 mm	31,60 mm

## HALOJEN FREE SİRAL ALEV YAYMAYAN 750 N

### HALOGEN FREE SPIRALS NON-FLAMMABLE 750N

  	001 020 750020 00 17	14,40 mm	19,85 mm
	001 020 750025 00 17	18,70 mm	24,70 mm
	001 020 750032 00 17	24,20 mm	31,60 mm

## HALOJEN FREE SİRAL ALEV YAYMAYAN KILAVUZ TELLİ 750 N

### HALOGEN FREE SPIRALS NON-FLAMMABLE WITH GUIDE WIRE 750N

  	001 020 751020 00 17	14,40 mm	19,85 mm
	001 020 751025 00 17	18,70 mm	24,70 mm
	001 020 751032 00 17	24,20 mm	31,60 mm

## HALOJEN FREE SPİRALLER 1250 N

HALOGEN-FREE SPIRALS 1250 N

Kod Code	İç Çap Inner Diameter	Dış Çap Outer Diameter
-------------	--------------------------	---------------------------

### HALOJEN FREE SPİRAL ALEV YAYAN 1250 N

HALOGEN FREE SPIRALS FLAMMABLE 1250 N

 TSE CE HF	001 020 240020 00 12	14,00 mm	19,85 mm
	001 020 240025 00 12	18,40 mm	24,70 mm
	001 020 240032 00 12	24,00 mm	31,60 mm

### HALOJEN FREE SPİRAL ALEV YAYAN KILAVUZ TELLİ 1250 N

HALOGEN FREE SPIRALS FLAMMABLE WITH GUIDE WIRE 1250 N

 TSE CE HF	001 020 241020 00 12	14,00 mm	19,85 mm
	001 020 241025 00 12	18,40 mm	24,70 mm
	001 020 241032 00 12	24,00 mm	31,60 mm

### HALOJEN FREE SPİRAL ALEV YAYMAYAN 1250 N

HALOGEN FREE SPIRALS NON-FLAMMABLE 1250 N

 TSE CE HF	001 020 250020 00 17	14,00 mm	19,85 mm
	001 020 250025 00 17	18,40 mm	24,70 mm
	001 020 250032 00 17	24,00 mm	31,60 mm

### HALOJEN FREE SPİRAL ALEV YAYMAYAN KILAVUZ TELLİ 1250 N

HALOGEN FREE SPIRALS FLAMMABLE WITH GUIDE WIRE 1250 N

 TSE CE HF	001 020 251020 00 17	14,00 mm	19,85 mm
	001 020 251025 00 17	18,40 mm	24,70 mm
	001 020 251032 00 17	24,00 mm	31,60 mm

## PLASTİK SİRİRAL BORULAR

### PLASTIC SPIRAL PIPES

	Kod Code	İç Çap Inner Diameter	Dış Çap Outer Diameter
--	-------------	--------------------------	---------------------------

### PLASTİK SİRİRALER

#### PLASTIC SPIRALS

	001 020 400014 00 11	15,25 mm	18,75 mm
	001 020 400016 00 11	15,70 mm	19,00 mm
	001 020 400018 00 11	19,60 mm	24,03 mm
	001 020 400020 00 11	19,60 mm	24,03 mm
	001 020 400026 00 11	26,15 mm	30,75 mm
	001 020 400032 00 11	29,10 mm	34,30 mm
	001 020 400040 00 11	36,20 mm	42,20 mm
	001 020 400050 00 11	48,50 mm	54,50 mm

### PLASTİK SİRİRALER KLAVUZ TELLİ

#### PLASTIC SPIRAL WITH GUIDE WIRE

	001 020 410014 00 11	15,25 mm	18,75 mm
	001 020 410016 00 11	15,70 mm	19,00 mm
	001 020 410018 00 11	19,60 mm	24,03 mm
	001 020 410020 00 11	19,60 mm	24,03 mm
	001 020 410026 00 11	26,15 mm	30,75 mm
	001 020 410032 00 11	29,10 mm	34,30 mm
	001 020 410040 00 11	36,20 mm	42,20 mm
	001 020 410050 00 11	48,50 mm	54,50 mm

### POLİPROPİLEN SİRİRALER

#### POLYPROPYLENE SPIRALS

	001 020 160007 00 17	7,00 mm	10,10 mm
	001 020 160009 00 17	8,40 mm	12,05 mm
	001 020 160010 00 17	10,20 mm	13,10 mm
	001 020 160012 00 17	12,30 mm	15,90 mm
	001 020 160014 00 17	14,10 mm	18,35 mm
	001 020 160017 00 17	17,00 mm	21,45 mm
	001 020 160019 00 17	19,00 mm	24,25 mm
	001 020 160023 00 17	23,25 mm	28,50 mm
	001 020 160026 00 17	26,20 mm	31,30 mm
	001 020 160029 00 17	29,10 mm	34,30 mm
	001 020 160036 00 17	36,20 mm	42,20 mm
	001 020 160048 00 17	48,50 mm	54,50 mm

### POLYAMİD SİRİRALER

#### POLYAMIDE SPIRALS

	001 020 170007 00 17	7,00 mm	10,10 mm
	001 020 170009 00 17	8,40 mm	12,05 mm
	001 020 170010 00 17	10,20 mm	13,10 mm
	001 020 170012 00 17	12,30 mm	15,90 mm
	001 020 170014 00 17	14,10 mm	18,35 mm
	001 020 170017 00 17	17,00 mm	21,45 mm
	001 020 170019 00 17	19,00 mm	24,25 mm
	001 020 170023 00 17	23,25 mm	28,50 mm
	001 020 170026 00 17	26,20 mm	31,30 mm
	001 020 170029 00 17	29,10 mm	34,30 mm
	001 020 170036 00 17	36,20 mm	42,20 mm
	001 020 170048 00 17	48,50 mm	54,50 mm

## POLYAMİD SPİRAL HALOGEN FREE PIPES

	Kod Code	Dış Çap Outer Diameter	Kutu Box	Adet Quantity	Metre Meter
--	-------------	---------------------------	-------------	------------------	----------------

### POLYAMİD YARIKLI SPİRAL BORU - ALEV YAYMAYAN POLYAMIDE SLOTTED SPIRAL PIPE - NON FLAME PROPAGATING

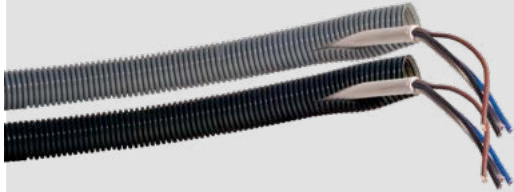
	001 020 470007 00 XX	7 Ø	1	1000	100 mt.
	001 020 470009 00 XX	8,5 Ø	1	1000	100 mt.
	001 020 470010 00 XX	10 Ø	1	1000	100 mt.
	001 020 470012 00 XX	12 Ø	1	500	100 mt.
	001 020 470014 00 XX	14 Ø	1	250	50 mt.
	001 020 470017 00 XX	17 Ø	1	250	50 mt.
	001 020 470019 00 XX	19 Ø	1	250	50 mt.
	001 020 470023 00 XX	23 Ø	1	250	50 mt.
	001 020 470026 00 XX	26 Ø	1	125	25 mt.
	001 020 470029 00 XX	29 Ø	1	125	25 mt.
	001 020 470036 00 XX	36 Ø	1	125	25 mt.
	00 470048 020 001 XX	48 Ø	1	125	25 mt.

### POLYAMİD SPİRAL RAKORLAR - GRİ/SİYAH POLYAMIDE SPIRAL CABLE GLANDS - GREY/BLACK

	Kod Code	Açıklama Description	Kutu Box	Adet Quantity
	057 097 110007	PSR-7	1	50
	057 097 110009	PSR-9	1	50
	057 097 110011	PSR-11	1	50
	057 097 110135	PSR-13,5	1	50
	057 097 110016	PSR-16	1	50
	057 097 110021	PSR-21	1	25
	057 097 110029	PSR-29	1	20
	057 097 110036	PSR-36	1	10
	057 097 110048	PSR-48	1	1

### POLYAMİD SPİRAL DİRSEĞİ - 90° - GRİ/SİYAH POLYAMIDE SPIRAL - 90° - GREY/BLACK

	Kod Code	Açıklama Description	Kutu Box	Adet Quantity
	057 097 120007	PSR-7	1	1
	057 097 120009	PSR-9	1	1
	057 097 120011	PSR-11	1	1
	057 097 120135	PSR-13,5	1	1
	057 097 120016	PSR-16	1	1
	057 097 120021	PSR-21	1	1

### POLYAMİD SPİRAL KROŞELERİ - GRİ/SİYAH POLYAMIDE SPIRAL CROCHET - GREY/BLACK

	Kod Code	Açıklama Description	Kutu Box	Adet Quantity
	057 097 160007	PSR-7	1	50
	057 097 160009	PSR-9	1	50
	057 097 160011	PSR-11	1	50
	057 097 160135	PSR-13,5	1	50
	057 097 160016	PSR-16	1	50
	057 097 160021	PSR-21	1	25
	057 097 160029	PSR-29	1	25
	057 097 160036	PSR-36	1	25
	057 097 160048	PSR-48	1	10



## PLASTİK SİRAL BORU AKSESUARLARI

### PLASTIC SPIRAL PIPES ACCESSORIES

	Kod Code	İç Çap Inner Diameter	Dış Çap Outer Diameter
<b>KABLO TOPLAMA SİRALI</b> CABLE ORGANISER SPIRAL			
	888 020 900001	10 mm	
	888 020 900003	16 mm	
	888 020 900004	16 mm	
	888 020 900006	22 mm	
	888 020 900007	22 mm	
	888 020 900009	28 mm	
	888 020 900010	28 mm	
	888 020 900011	34 mm	

<b>SİRAL BİRLEŞTİRİCİ</b> SPIRAL COUPLER			
	001 020 990016 00 17	16 mm	
	001 020 990020 00 17	20 mm	
	001 020 990025 00 17	25 mm	
	001 020 990032 00 17	32 mm	

<b>HELEZON PANO SİRALI</b> HELICOID PANEL SPIRAL	Ürün Adı Product Name	Dış Çap Outer Diameter	Boy Size	Adet Quantity	
	001 020 500001 05 00	No:1	5,5 mm	50 cm	100
	001 020 500002 05 00	No:2	7,5 mm	50 cm	100
	001 020 500003 05 00	No:3	10,0 mm	50 cm	100
	001 020 500004 05 00	No:4	13,0 mm	50 cm	50
	001 020 500005 05 00	No:5	15,0 mm	50 cm	50

<b>HELEZON PANO SİRALI (RULO)</b> HELICOID PANEL SPIRAL (ROLL)	Ürün Adı Product Name	Dış Çap Outer Diameter	Adet Boyu Quantity Size	
	001 020 600001 00 00	No:1	5,5 mm	100 mt. Rulo
	001 020 600002 00 00	No:2	7,5 mm	100 mt. Rulo
	001 020 600003 00 00	No:3	10,0 mm	100 mt. Rulo
	001 020 600004 00 00	No:4	13,0 mm	100 mt. Rulo
	001 020 600005 00 00	No:5	15,0 mm	100 mt. Rulo

# HAZIR SPİRALLİ KABLolar

## PREWIRED ELECTRO CONDUITS

	Kod Code	Kablo Kesiti mm <sup>2</sup> Cable Dimension mm <sup>2</sup>	Spiral Özellik Spiral Specification	Spiral Çap (mm) Spiral Diameter (mm)
--	-------------	---	--	---

### SPİRALLİ ENERJİ KABLolar

#### SPIRALS ENERGY CABLES

### H07V-U (NYA) KABLolar

#### H07V-U (NYA) ENERGY CABLES

	122 050 215014	2x1.5	HF-PE	14
	122 050 315014	3x1.5	HF-PE	14
	122 050 415016	4x1.5	HF-PE	16
	122 050 225014	2x2.5	HF-PE	14
	122 050 325016	3x2.5	HF-PE	16
	122 050 425020	4x2.5	HF-PE	20

### H07V-U (NYA) KABLolar HALOGEN FREE

#### H07V-U (NYA) ENERGY CABLES HALOGEN FREE

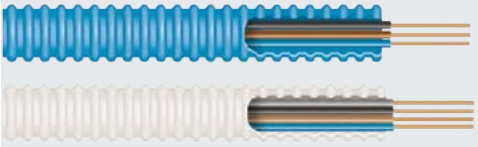

	122 051 215014	2x1.5	HF-PE	14
	122 051 315014	3x1.5	HF-PE	14
	122 051 415016	4x1.5	HF-PE	16
	122 051 225014	2x2.5	HF-PE	14
	122 051 325016	3x2.5	HF-PE	16
	122 051 425020	4x2.5	HF-PE	20

### SPİRALLİ ZAYIF AKIM KABLolar

#### SPIRALS LOW CURRENT CABLES

#### DATA KABLolar

##### DATA CABLES

	122 052 100516	U / UTP CAT5e	HF-PE	16
	122 052 100616	U / UTP CAT6e	HF-PE	16

#### KOAKSİYEL KABLolar

##### TV CABLES

	122 052 200214	RG 59/U2 (cu/AL)	HF-PE	14
	122 052 200416	RG 6/U4 (cu/AL)	HF-PE	16
	122 052 200616	RG 6/U6 (cu/AL)	HF-PE	16

#### CCTV KAMERA KABLolar

##### CCTV CAMERA CABLES

	122 052 301214	CCTV 1+2 (2x0.22mm <sup>2</sup> )	HF-PE	14
	122 052 301416	CCTV 1+4 (2x2x0.22mm <sup>2</sup> )	HF-PE	16

#### JY (st) Y YANGIN İHBAR KABLolar

##### JY (st) Y FIRE SYSTEM CABLES

	122 052 401216	JY(st)Y 1x2x0.80+40 mm <sup>2</sup>	HF-PE	16
	122 052 402216	JY(st)Y 2x2x0.80+40 mm <sup>2</sup>	HF-PE	16
	122 052 404216	JY(st)Y 4x2x0.80+40 mm <sup>2</sup>	HF-PE	20

#### DİYAFON KABLolar

##### INTERCOM CABLES

	122 052 502216	DT-8 8x0.22 mm <sup>2</sup>	HF-PE	16
---	----------------	-----------------------------	-------	----

# HAZIR SPİRALLİ KABLolar

## PREWIRED ELECTRO CONDUITS

Kod  
Code

Kablo Kesiti mm<sup>2</sup>  
Cable Dimension mm<sup>2</sup>

Spiral Özellik  
Spiral Specification

Spiral Çap (mm)  
Spiral Diameter (mm)

### SPİRALLİ ZAYIF AKIM KABLolar HALOGEN FREE

#### SPIRALS LOW CURRENT CABLES HALOGEN FREE



#### (LSZH) DATA KABLolar HALOGEN FREE

##### (LSZH) DATA CABLES HALOGEN FREE

122 053 100516	U / UTP CAT5e (4x2x24 AWG)	HF-PE	16
122 053 100616	U / UTP CAT6 (4x2x23 AWG)	HF-PE	16

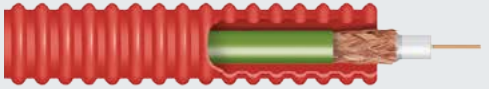

#### (PHY-HF) KOAKSİYEL KABLolar HALOGEN FREE

##### (PHY-HF) TV CABLES HALOGEN FREE

122 053 200416	RG 59/U2 (cu/AL)	HF-PE	16
122 052 200616	RG 6/U4 (cu/AL)	HF-PE	16

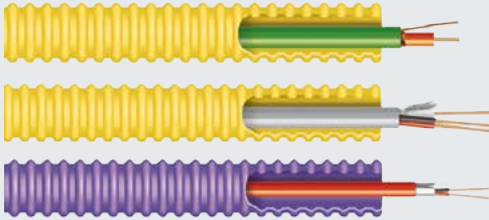

#### CCTV KAMERA KABLolar HALOGEN FREE

##### CCTV CAMERA CABLES HALOGEN FREE

122 052 301214	CCTV 1+2 (2x0.22mm <sup>2</sup> )	HF-PE	14
122 052 301416	CCTV 1+4 (2x2x0.22mm <sup>2</sup> )	HF-PE	16

#### JY (st) Y YANGIN İHBAR KABLolar HALOGEN FREE

##### JY (st) Y FIRE SYSTEM HALOGEN FREE



122 052 401216	JY(st)Y 1x2x0.80+40 mm <sup>2</sup>	HF-PE	16
122 052 402216	JY(st)Y 2x2x0.80+40 mm <sup>2</sup>	HF-PE	16
122 052 404216	JY(st)Y 4x2x0.80+40 mm <sup>2</sup>	HF-PE	20

#### LIHH DİYAFON KABLolar HALOGEN FREE

##### (LIHH) INTERCOM CABLES HALOGEN FREE



122 052 502216	DT-8 8x0.22 mm <sup>2</sup>	HF-PE	16
----------------	-----------------------------	-------	----

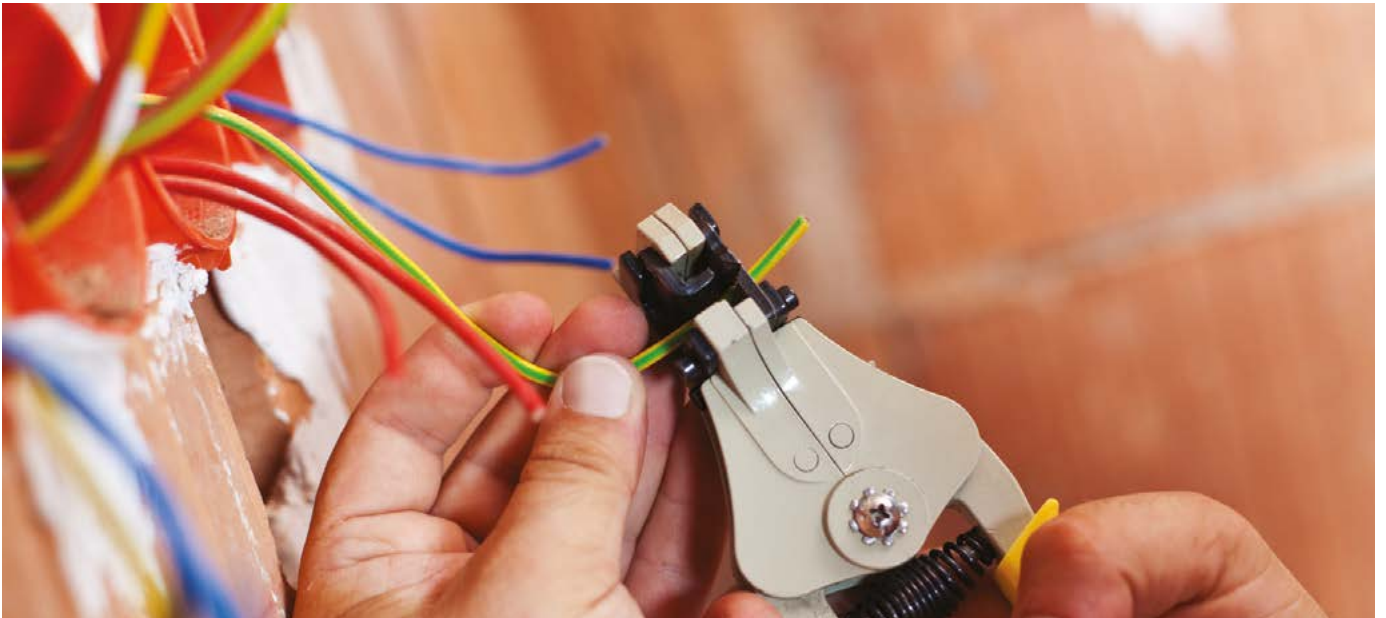

## HALOJEN FREE RİJİT ALEV YAYMAYAN BORULAR FLARET HALOGEN FREE NON-FLAMMABLE RIGIT PIPES

	Kod Code	İç Çap Inner Diameter	Dış Çap (+0,-0.3) Outer Diameter
--	-------------	--------------------------	-------------------------------------

### FLARET HALOJEN FREE ALEV YAYMAYAN BORULAR - 320 N FLARET HALOGEN FREE NON-FLAMMABLE PIPES -320N

	001 045 500016 30 17	12.4 mm	16 mm
	001 045 500020 30 17	16.6 mm	20 mm
	001 045 500025 30 17	20.6 mm	25 mm
	001 045 500032 30 17	28.8 mm	32 mm
	001 045 500040 30 17	36.7 mm	40 mm
	001 045 500050 30 17	42.9 mm	50 mm

### FLARET HALOJEN FREE ALEV YAYMAYAN BORULAR - 750 N FLARET HALOGEN FREE NON-FLAMMABLE PIPES -750 N

	001 045 510016 30 17	12.4 mm	16 mm
	001 045 510020 30 17	16.0 mm	20 mm
	001 045 510025 30 17	20.6 mm	25 mm
	001 045 510032 30 17	26.8 mm	32 mm
	001 045 510040 30 17	33.9 mm	40 mm
	001 045 510050 30 17	42.9 mm	50 mm

### FLARET HALOJEN FREE ALEV YAYMAYAN BORULAR - 1250 N FLARET HALOGEN FREE NON-FLAMMABLE PIPES -1250 N

	001 045 520016 30 17	12.1 mm	16 mm
	001 045 520020 30 17	15.2 mm	20 mm
	001 045 520025 30 17	20.0 mm	25 mm
	001 045 520032 30 17	25.9 mm	32 mm
	001 045 520040 30 17	32.3 mm	40 mm
	001 045 520050 30 17	42.0 mm	50 mm









## PVC ALEV YAYMAYAN RİJİT BORULAR

### PVC NON-FLAMMABLE RIGIT PIPES

	Kod Code	İç Çap Inner Diameter	Dış Çap (+0,-0.3) Outer Diameter
--	-------------	--------------------------	-------------------------------------

### PVC ALEV YAYMAYAN BORULAR 750 N

#### PVC NON-FLAMMABLE PIPES 750 N

 <p>Flame Retardant Alev Yayımayan</p>	001 045 120014 30 17	11,80 mm	14 mm
	 001 045 120016 30 17	12,80 mm	16 mm
	001 045 120018 30 17	16,50 mm	18 mm
	 001 045 120020 30 17	16,70 mm	20 mm
	 001 045 120025 30 17	21,90 mm	25 mm
	 001 045 120032 30 17	29 mm	32 mm
	 001 045 120040 30 17	37,40 mm	40 mm

### PVC KENDİNDEN MUFLU ALEV YAYMAYAN BORULAR 750 N

#### PVC SELF FITTING NON-FLAMMABLE PIPES 750 N

 <p>Flame Retardant Alev Yayımayan</p>	001 045 110014 30 17	11,80 mm	14 mm
	 001 045 110016 30 17	12,80 mm	15,90 mm
	001 045 110018 30 17	15,50 mm	18 mm
	 001 045 110020 30 17	16,70 mm	19,90 mm
	 001 045 110025 30 17	21,90 mm	24,80 mm
	 001 045 110032 30 17	29 mm	31,89mm
	001 045 110040 30 17	37,40 mm	39,89 mm

### DİRSEKLER

#### BRACKETS

 <p>Flame Retardant Alev Yayımayan</p>	 001 051 010014 00 17	14 mm	18 mm
	 001 051 010016 00 17	16 mm	20 mm
	 001 051 010018 00 17	18 mm	22 mm
	 001 051 010020 00 17	20 mm	24 mm
	 001 051 010025 00 17	25 mm	29 mm
	 001 051 010032 00 17	32 mm	36 mm

### MUFLAR

#### COUPLER FITTING

 <p>Flame Retardant Alev Yayımayan</p>	 001 051 030014 00 17	14 mm	18 mm
	 001 051 030016 00 17	16 mm	20 mm
	 001 051 030018 00 17	18 mm	22 mm
	 001 051 030020 00 17	20 mm	24 mm
	 001 051 030025 00 17	25 mm	29 mm
	 001 051 030032 00 17	32 mm	36 mm









## SİBOR SERİSİ HALOJEN FREE TURUNCU BORULAR

### SIBOR SERIES HALOGEN FREE ORANGE PIPES

	Kod Code	İç Çap Inner Diameter	Dış Çap (+0,-0.3) Outer Diameter
--	-------------	--------------------------	-------------------------------------









#### SİBOR SERİSİ ALEV YAYAN 125 N

#### SIBOR SERIES FLAMMABLE 125 N

  <b>IP40</b>	001 165 706014 00 12	10.4 mm	14 mm
	 001 165 706016 00 12	12.4 mm	16 mm
	001 165 706018 00 12	14.6 mm	18 mm
	 001 165 706020 00 12	16.6 mm	20 mm
	 001 165 706025 00 12	20.6 mm	25 mm
	 001 165 706032 00 12	28.8 mm	32 mm
	001 165 706037 00 12	33.6 mm	37 mm
	 001 165 706040 00 12	36.7 mm	40 mm
 001 165 706050 00 12	42.9 mm	50 mm	









#### SİBOR SERİSİ ALEV YAYMAYAN 125 N

#### SIBOR SERIES NON-FLAMMABLE 125 N

   <b>IP40</b>	001 165 206014 00 12	10.4 mm	14 mm
	 001 165 206016 00 12	12.4 mm	16 mm
	001 165 206018 00 12	14.6 mm	18 mm
	 001 165 206020 00 12	16.6 mm	20 mm
	 001 165 206025 00 12	20.6 mm	25 mm
	 001 165 206032 00 12	28.8 mm	32 mm
	001 165 206037 00 12	33.6 mm	37 mm
	 001 165 206040 00 12	36.7 mm	40 mm
 001 165 206050 00 12	42.9 mm	50 mm	









#### SİBOR SERİSİ ALEV YAYAN 320 N

#### SIBOR SERIES FLAMMABLE 320 N

  <b>IP40</b>	001 165 710014 00 12	9.4 mm	14 mm
	 001 165 710016 00 12	12.4 mm	16 mm
	001 165 710018 00 12	13.6 mm	18 mm
	 001 165 710020 00 12	16.0 mm	20 mm
	 001 165 710025 00 12	20.6 mm	25 mm
	 001 165 710032 00 12	26.8 mm	32 mm
	001 165 710037 00 12	33.6 mm	37 mm
	 001 165 710040 00 12	33.9 mm	40 mm
 001 165 710050 00 12	42.9 mm	50 mm	

#### SİBOR SERİSİ ALEV YAYMAYAN 320 N

#### SIBOR SERIES NON-FLAMMABLE 320 N

   <b>IP40</b>	001 165 210014 00 12	9.4 mm	14 mm
	 001 165 210016 00 12	12.4 mm	16 mm
	001 165 210018 00 12	13.6 mm	18 mm
	 001 165 210020 00 12	16.0 mm	20 mm
	 001 165 210025 00 12	20.6 mm	25 mm
	 001 165 210032 00 12	26.8 mm	32 mm
	001 165 210037 00 12	33.6 mm	37 mm
	 001 165 210040 00 12	33.9 mm	40 mm
 001 165 210050 00 12	42.9 mm	50 mm	

## MEKS SERİSİ POLİETİLEN HALOJEN FREE BORULAR

### MEKS SERIES POLYETHYLENE HALOGEN FREE PIPES

	Kod Code	İç Çap Inner Diameter	Dış Çap Outer Diameter
<b>MEKS SERİSİ 6 ATÜ HALOJEN FREE ALEV YAYAN - 320 N</b> MEKS SERIES 6 ATU HALOGEN FREE FLAMMABLE - 320 N			
   <b>IP40</b>	001 165 506014 00 12	11,25 mm	14,50 mm
	 001 165 506016 00 12	12,65 mm	15,85 mm
	001 165 506018 00 12	14,60 mm	18 mm
	 001 165 506020 00 12	16,45 mm	19,85 mm
	 001 165 506025 00 12	20,80 mm	24,80 mm
	 001 165 506032 00 12	26,80 mm	31,80 mm
	001 165 506037 00 12	30,80 mm	36,80 mm
	 001 165 506040 00 12	33,90 mm	39,80 mm
	 001 165 506050 00 12	42,90 mm	49,75 mm
	 001 165 506063 00 12	55,30 mm	62,70 mm
	 001 165 506075 00 12	66 mm	74,70 mm
	001 165 506090 00 12	81,80 mm	90,85 mm

<b>MEKS SERİSİ 10 ATÜ HALOJEN FREE ALEV YAYAN - 750 N</b> MEKS SERIES 10 ATU HALOGEN FREE FLAMMABLE - 750 N			
   <b>IP40</b>	001 165 510014 00 12	10,70 mm	14,45 mm
	 001 165 510016 00 12	12 mm	15,85 mm
	001 165 510018 00 12	14,60 mm	18 mm
	 001 165 510020 00 12	15,15 mm	19,85 mm
	 001 165 510025 00 12	19,80 mm	24,80 mm
	 001 165 510032 00 12	25,25 mm	31,80 mm
	001 165 510037 00 12	29,50 mm	36,80 mm
	 001 165 510040 00 12	32,30 mm	39,80 mm
	 001 165 510050 00 12	42 mm	49,75 mm
	 001 165 510063 00 12	52,90 mm	62,70 mm
	 001 165 510075 00 12	64,30 mm	74,70 mm
	001 165 510090 00 12	78,80 mm	90,85 mm
	001 165 510100 00 12	89,90 mm	100,95 mm
	001 165 510110 00 12	95 mm	111 mm

## MEKS SERİSİ POLİETİLEN HALOJEN FREE BORULAR

### MEKS SERIES POLYETHYLENE HALOGEN FREE PIPES

	Kod Code	İç Çap Inner Diameter	Dış Çap Outer Diameter
--	-------------	--------------------------	---------------------------

#### MEKS SERİSİ 6 ATÜ HALOJEN FREE ALEV YAYMAYAN - 320 N

#### MEKS SERIES 6 ATU HALOGEN FREE NON-FLAMMABLE - 320 N

 <p>HF HALOJEN FREE Flame Retardant Alev Yayımayan</p> <p><b>IP40</b></p>	001 165 106014 00 12	11,25 mm	14,50 mm
	 001 165 106016 00 12	12,65 mm	15,85 mm
	001 165 106018 00 12	14,60 mm	18 mm
	 001 165 106020 00 12	16,45 mm	19,85 mm
	 001 165 106025 00 12	20,80 mm	24,80 mm
	 001 165 106032 00 12	26,80 mm	31,80 mm
	001 165 106037 00 12	30,80 mm	36,80 mm
	 001 165 106040 00 12	33,90 mm	39,80 mm
	 001 165 106050 00 12	42,90 mm	49,75 mm
	 001 165 106063 00 12	55,30 mm	62,70 mm
	 001 165 106075 00 12	66 mm	74,70 mm
	001 165 106090 00 12	81,80 mm	90,85 mm

#### MEKS SERİSİ 10 ATÜ HALOJEN FREE ALEV YAYMAYAN - 750 N











#### MEKS SERIES 10 ATU HALOGEN FREE NON-FLAMMABLE - 750 N

 <p>HF HALOJEN FREE Flame Retardant Alev Yayımayan</p> <p><b>IP40</b></p>	001 165 110014 00 12	10,70 mm	14,45 mm
	 001 165 110016 00 12	12 mm	15,85 mm
	001 165 110018 00 12	14,60 mm	18 mm
	 001 165 110020 00 12	15,15 mm	19,85 mm
	 001 165 110025 00 12	19,80 mm	24,80 mm
	 001 165 110032 00 12	25,25 mm	31,80 mm
	001 165 110037 00 12	29,50 mm	36,80 mm
	 001 165 110040 00 12	32,30 mm	39,80 mm
	 001 165 110050 00 12	42 mm	49,75 mm
	 001 165 110063 00 12	52,90 mm	62,70 mm
	 001 165 110075 00 12	64,30 mm	74,70 mm
	001 165 110090 00 12	78,80 mm	90,85 mm
	001 165 110100 00 12	89,90 mm	100,95 mm
	001 165 110110 00 12	95 mm	111 mm



## MEKS SERİSİ POLİETİLEN HALOJEN FREE BORULAR

### MEKS SERIES POLYETHYLENE HALOGEN FREE PIPES

	Kod Code	Ort. İç Çap Inner Diameter	Ort. Dış Çap Outer Diameter
<b>MEKS SERİSİ HALOJEN FREE ALEV YAYAN - 1250 N</b> MEKS SERIES HALOGEN FREE FLAMMABLE - 1250 N			
  <p><b>IP40</b></p> <p></p>	001 165 512014 00 12	9,25 mm	14,50 mm
	 001 165 512016 00 12	10,70 mm	15,85 mm
	001 165 512018 00 12	12,60 mm	18 mm
	 001 165 512020 00 12	14,50 mm	19,85 mm
	 001 165 512025 00 12	18,00 mm	24,80 mm
	 001 165 512032 00 12	25,80 mm	31,80 mm
	001 165 512037 00 12	30,80 mm	36,80 mm
	 001 165 512040 00 12	33,90 mm	39,80 mm
	 001 165 512050 00 12	43,50 mm	49,75 mm
	 001 165 512063 00 12	52,90 mm	62,70 mm
	 001 165 512075 00 12	64,30 mm	74,70 mm
	001 165 512090 00 12	79,80 mm	90,00 mm

<b>MEKS SERİSİ HALOJEN FREE ALEV YAYMAYAN - 1250 N</b> MEKS SERIES HALOGEN FREE NON-FLAMMABLE - 1250 N			
  <p><b>IP40</b></p> <p> </p>	001 165 112014 00 12	9,25 mm	14,45 mm
	 001 165 112016 00 12	10,70 mm	15,85 mm
	001 165 112018 00 12	12,60 mm	18 mm
	 001 165 112020 00 12	14,50 mm	19,85 mm
	 001 165 112025 00 12	18,00 mm	24,80 mm
	 001 165 112032 00 12	25,80 mm	31,80 mm
	001 165 112037 00 12	30,80 mm	36,80 mm
	 001 165 112040 00 12	33,90 mm	39,80 mm
	 001 165 112050 00 12	43,50 mm	49,75 mm
	 001 165 112063 00 12	52,90 mm	62,70 mm
	 001 165 112075 00 12	64,30 mm	74,70 mm
	001 165 112090 00 12	79,80 mm	90,00 mm









## POLİETİLEN SİYAH YERALTI BORULARI

### POLYETHYLENE BLACK UNDERGROUND PIPES

	Kod Code	Ort. İç Çap Inner Diameter	Ort. Dış Çap Outer Diameter
--	-------------	-------------------------------	--------------------------------









#### 6 ATÜ 450 N

6 ATU 450 N

	001 165 406014 00 11	11,50 mm	14,65 mm
	001 165 406016 00 11	12,75 mm	16 mm
	001 165 406018 00 11	14,70 mm	18,10 mm
	001 165 406020 00 11	16,25 mm	20 mm
	 001 165 406025 00 11	20,79 mm	25 mm
	 001 165 406032 00 11	26,80 mm	32 mm
	001 165 406037 00 11	30,27 mm	37 mm
	 001 165 406040 00 11	33,90 mm	40 mm
	 001 165 406050 00 11	42,90 mm	50 mm
	 001 165 406063 00 11	55,30 mm	63 mm
	 001 165 406075 00 11	66 mm	75 mm
	 001 165 406090 00 11	81,80 mm	90 mm

#### 10 ATÜ 750 N

10 ATU 750 N

	001 165 410014 00 11	10,50 mm	14,65 mm
	001 165 410016 00 11	12 mm	16 mm
	001 165 410018 00 11	14,30 mm	18,10 mm
	001 165 410020 00 11	15,30 mm	20 mm
	 001 165 410025 00 11	19,80 mm	25 mm
	 001 165 410032 00 11	25,80 mm	32 mm
	001 165 410037 00 11	29,50 mm	37 mm
	 001 165 410040 00 11	32,30 mm	40 mm
	 001 165 410050 00 11	42 mm	50 mm
	 001 165 410063 00 11	52,90 mm	63 mm
	 001 165 410075 00 11	64,30 mm	75 mm
	 001 165 410090 00 11	78,80 mm	90 mm
001 165 410100 00 11	89,90 mm	100 mm	
 001 165 410110 00 11	95 mm	110 mm	

#### PLASTİK BORULAR

PLASTIC PIPES

	001 045 000014 30 00	14 mm Kalın Boy Boru	14 mm Thick Pipes
	001 045 000018 30 00	18 mm Kalın Boy Boru	18 mm Thick Pipes
	001 045 000026 30 00	26 mm Kalın Boy Boru	26 mm Thick Pipes
	001 045 000037 30 00	37 mm Kalın Boy Boru	37 mm Thick Pipes
	001 045 010014 00 11	14 mm Kangal (Normal)	14 mm Coil (Normal)
	001 045 010018 00 11	18 mm Kangal (Normal)	18 mm Coil (Normal)
	001 045 010026 00 11	26 mm Kangal (Normal)	26 mm Coil (Normal)
	001 045 010037 00 11	37 mm Kangal (Normal)	37 mm Coil (Normal)

#### KAUÇUK BORULAR

RUBBER PIPES

	001 045 020014 00 00	14 mm Kangal (Kauçuk)	14 mm Coil (Rubber)
	001 045 020018 00 00	18 mm Kangal (Kauçuk)	18 mm Coil (Rubber)
	001 045 020026 00 00	26 mm Kangal (Kauçuk)	26 mm Coil (Rubber)
	001 045 020037 00 00	37 mm Kangal (Kauçuk)	37 mm Coil (Rubber)
	001 045 030014 00 00	14 mm Kangal (Kauçuk) (Kalın)	14 mm Coil (Rubber) (Thick)
	001 045 030018 00 00	18 mm Kangal (Kauçuk) (Kalın)	18 mm Coil (Rubber) (Thick)

## SUSTALAR VE BUAT KAPAKLARI

### CABLE PULLERS AND JUNCTION BOX COVERS

	Kod Code	Açıklama Description	Ambalaj Packing	Adet Quantity	Ağırlık Weight	Hacim Volume
--	-------------	-------------------------	--------------------	------------------	-------------------	-----------------

#### LÜX BUAT KAPAKLARI

##### LUX JUNCTION BOX COVERS

	126 046 180003	<b>Lüx Buat Kapağı (Plastik Ayak) Düz</b> Lux Junction Box Cover (Plastic Trivet) Flat	Kutu Pack	500	6 Kg	0.195
	126 046 180004	<b>L. B. K. (Bombeli - Pls. Ayak) Demir Vidalı 1. Kalite</b> Lux Junction Box Cover (Curved-Plastic Trivet) Iron Screw, Premium Quality	Kutu Pack	500	7.5 Kg	0.195
	126 046 180001	<b>Lüx Buat Kapağı (Bombeli-Plastik Ayak)</b> Lux Junction Box Cover (Curved-Plastic Trivet)	Kutu Pack	500	6 Kg	0.195

#### PVC İZOLE KAPLI ÇELİK SUSTA

##### PVC INSULATION COATED STEEL CABLE PULLER

	049 019 300010	<b>PVC İzole Kaplı Çelik Susta 10 mt</b> PVC Insulation Coated Steel Cable Puller 10 m	Kutu Pack	-	-	-
	049 019 300015	<b>PVC İzole Kaplı Çelik Susta 15 mt</b> PVC Insulation Coated Steel Cable Puller 15 m	Kutu Pack	-	-	-
	049 019 300020	<b>PVC İzole Kaplı Çelik Susta 20 mt</b> PVC Insulation Coated Steel Cable Puller 20 m	Kutu Pack	-	-	-
	049 019 300025	<b>PVC İzole Kaplı Çelik Susta 25 mt</b> PVC Insulation Coated Steel Cable Puller 25 m	Kutu Pack	-	-	-

#### PLASTİK SUSTA (KLAVUZ TELLİ)

##### PLASTIC CABLE PULLER (WITH GUIDE WIRE)

	049 019 400010	<b>Takviyeli Plastik Susta 10 mt</b> Plastic Cable Puller (with guide wire) 10 mt	Kutu Pack	-	-	-
	049 019 400015	<b>Takviyeli Plastik Susta 15 mt</b> Plastic Cable Puller (with guide wire) 15 mt	Kutu Pack	-	-	-
	049 019 400020	<b>Takviyeli Plastik Susta 20 mt</b> Plastic Cable Puller (with guide wire) 20 mt	Kutu Pack	-	-	-
	049 019 400025	<b>Takviyeli Plastik Susta 25 mt</b> Plastic Cable Puller (with guide wire) 25 mt	Kutu Pack	-	-	-

#### ÇELİK SUSTA

##### STEEL CABLE PULLER

	001 019 000010 00 00	<b>1.Kalite 10 mt'lik Susta</b> Premium Quality Cable Puller, 10 m	Kutu Pack	40	27.60 Kg	0.025
	001 019 000015 00 00	<b>1.Kalite 15 mt'lik Susta</b> Premium Quality Cable Puller, 15 m	Kutu Pack	30	31.08 Kg	0.025
	001 019 000020 00 00	<b>1.Kalite 20 mt'lik Susta</b> Premium Quality Cable Puller, 20 m	Kutu Pack	20	27.56 Kg	0.025
	001 019 000025 00 00	<b>1.Kalite 25 mt'lik Susta</b> Premium Quality Cable Puller, 25 m	Kutu Pack	15	25.8 Kg	0.025
	001 019 100010 00 00	<b>1. Kalite 10 mt'lik Tak. Susta</b> Premium Quality Cable Puller, 10 m, Reinforced	Kutu Pack	40	28.64 Kg	0.025
	001 019 100015 00 00	<b>1. Kalite 15 mt'lik Tak. Susta</b> Premium Quality Cable Puller, 15 m, Reinforced	Kutu Pack	30	31.98 Kg	0.025
	001 019 100020 00 00	<b>1. Kalite 20 mt'lik Tak. Susta</b> Premium Quality Cable Puller, 20 m, Reinforced	Kutu Pack	20	28.36 Kg	0.025
	001 019 100025 00 00	<b>1. Kalite 25 mt'lik Tak. Susta</b> Premium Quality Cable Puller, 25 m, Reinforced	Kutu Pack	15	26.55 Kg	0.025
	001 019 000001 00 00	<b>Florasın Zinciri</b> Fluorescent Chain	Kutu Pack	500 m	20.50 Kg	0.017

## BETON DUVAR KASALARI CONCRETE WALL CASINGS

	Kod Code	Açıklama Description	Ambalaj Packing	Adet Quantity	Ağırlık Weight	Hacim Volume
	000 700 200037 00 14 	<b>Buat Arka Kapak (Sarı)</b> Junction Box Back Cover (Yellow)	Kutu Pack	500	6 Kg	0.018
	000 700 000037 00 14					
	000 700 200035 00 12 	<b>Buat Gövde 60'lık (Turuncu)</b> Junction Box Body, 60 mm (Orange)	Kutu Pack	350	9.45 Kg	0.130
	000 700 000035 00 12					
	000 700 200256 00 14 	<b>Kalıba Tespit Elemanı (Sarı)</b> Die Fixing Tool (Orange)	Kutu Pack	250	4.09 Kg	0.65
	000 700 000256 00 14					
	000 700 200039 00 12 	<b>Sığ Brüt Anahtar Kasası (Turuncu)</b> Shallow Gross Switch Case (Orange)	Kutu Pack	500	12.53 Kg	0.130
	000 700 000039 00 12					
	000 700 200036 00 14 	<b>Konik Gövde (Sarı)</b> Conical Body (Yellow)	Kutu Pack	250	4.63 Kg.	0.034
	000 700 000036 00 14					
	000 700 200214 00 14 	<b>Aplik 20'lik (Sarı)</b> Bracket Lamp, 20 mm (Yellow)	Kutu Pack	1000	4.34 Kg	0.029
	000 700 000214 00 14					
	000 700 200215 00 12 	<b>Aplik Eğik Bağlantı Dirseği (Turuncu)</b> Bracket Lamp Scarf Joint Bracket (Orange)	Kutu Pack	1000	3.54 Kg	0.039
	000 700 000215 00 12					



## PLASTİK KASA VE BUATLAR

### PLASTIC CASINGS AND JUNCTION BOXES

	Kod Code	Açıklama Description
<b>TURUNCU BUAT VE KASALAR</b> ORANGE JUNCTION BOXES AND CASINGS		
	  001 046 131102 00 12 001 046 130102 00 12	<b>Norm Kasa</b> Norm Casing
	  001 046 131101 00 12 001 046 130101 00 12	<b>Norm Buat Ø 14 Ø 18 Çıkışlı</b> Norm Junction Box (with Ø14, Ø18 Outlets)
	  001 046 161102 00 12 001 046 160102 00 12 001 046 150001 00 12	<b>Geçmeli Plastik Kasa</b> Click-Fit Plastic Casing <b>Geçmeli Derin Kasa Uzatma Parçası</b> Plastic Deep Box - Extension Part
	  001 046 161101 00 12 001 046 160101 00 12	<b>Geçmeli Derin Kasa</b> Click-Fit Deep Casing
	 001 046 121100 00 12 001 046 120100 00 12	<b>Geçmeli Alçıpan Kasa</b> Click-Fit Drywall Casing
	  000 700 100160 00 12 000 700 000160 00 12	<b>Geçmeli Derin Kasa Gövde</b> Click-Fit Deep Casing Body
	  000 700 100073 00 12 000 700 000073 00 12	<b>Geçmeli Derin Kasa Kapak</b> Click-Fit Deep Casing Cover
	  001 046 121101 00 12 001 046 120101 00 12	<b>Alçıpan Kasa 1'li</b> Drywall Casing, Single
	  001 046 121102 00 12 001 046 120102 00 12	<b>Alçıpan Kasa 2'li</b> Drywall Casing, Double
	  001 046 121103 00 12 001 046 120103 00 12	<b>Alçıpan Kasa 3'lü</b> Drywall Casing, Triple
	  001 046 210002 00 12 001 046 170101 00 12	<b>Tünel Kasa</b> Tunnel Casing
	  001 046 210003 00 12 001 046 170102 00 12	<b>Tünel Buat</b> Tunnel Junction Box

## SİYAH BUAT VE KASALAR

### BLACK JUNCTION BOXES AND CASINGS

	126 046 130103	<b>Norm Kasa</b> Norm Casing
	126 046 130104	<b>Norm Buat Ø 14 Ø 18 Çıkışlı</b> Norm Junction Box (with Ø14, Ø18 Outlets)
	126 046 130106	<b>Geçmeli Derin Kasa</b> Click-Fit Deep Casing
	001 046 120100 00 11	<b>Geçmeli Alçıpan Kasa</b> Click-Fit Drywall Casing
	001 046 160102 00 00	<b>Geçmeli Plastik Kasa</b> Click-Fit Plastic Casing
	001 046 120101 00 11	<b>Alçıpan Kasa 1'li</b> Drywall Casing, Single
	001 046 120102 00 11	<b>Alçıpan Kasa 2'li</b> Drywall Casing, Double
	001 046 120103 00 11	<b>Alçıpan Kasa 3'lü</b> Drywall Casing, Triple
	001 046 170101 00 11	<b>Tünel Kasa</b> Tunnel Casing
001 046 170102 00 11	<b>Tünel Buat</b> Tunnel Junction Box	

## PLASTİK DİRSEKLER

### PLASTIC BRACKETS

	127 051 000014	<b>Plastik Ø 14 Dirsek</b> Plastic Bracket, Ø14
	127 051 000018	<b>Plastik Ø 18 Dirsek</b> Plastic Bracket, Ø18
	127 051 000026	<b>Plastik Ø 26 Dirsek</b> Plastic Bracket, Ø26

## PLASTİK MUFLAR

### PLASTIC PIPE SOCKETS

	001 051 020014 00 11	<b>Plastik Ø 14 Muf</b> Plastic Pipe Socket, Ø14
	001 051 020018 00 11	<b>Plastik Ø 18 Muf</b> Plastic Pipe Socket, Ø18
	001 051 020026 00 11	<b>Plastik Ø 26 Muf</b> Plastic Pipe Socket, Ø26
	001 051 020037 00 11	<b>Plastik Ø 37 Muf</b> Plastic Pipe Socket, Ø37
	001 046 000001 00 11	<b>Plastik Takoz (Ø 14 Ø 18 Çıkışlı)</b> Plastic Cleat (with Ø14, Ø18 Outlets)

## KROŞELER CABLE STRAPS

	Kod Code	Açıklama Description	Ambalaj Packing	Adet Quantity	Ağırlık Weight	Hacim Volume
--	-------------	-------------------------	--------------------	------------------	-------------------	-----------------

### ANTİGRON BORU KROŞELERİ ANTIGRON PIPE STRAPS

	001 048 010016 00 17	<b>16'lik Antigron Boru Kroşesi</b> Antigron Pipe Straps, Ø16	Kutu Pack	100	0,55 Kg	0,00210
	001 048 010018 00 17	<b>18'lik Antigron Boru Kroşesi</b> Antigron Pipe Straps, Ø18	Kutu Pack	100	0,42 Kg	0,00200
	001 048 010020 00 17	<b>20'lik Antigron Boru Kroşesi</b> Antigron Pipe Straps, Ø20	Kutu Pack	100	0,48 Kg	0,00243
	001 048 010022 00 17	<b>22'lik Antigron Boru Kroşesi</b> Antigron Pipe Straps, Ø22	Kutu Pack	-	-	-
	001 048 010025 00 17	<b>25'lik Antigron Boru Kroşesi</b> Antigron Pipe Straps, Ø25	Kutu Pack	100	0,59 Kg	0,00365
	001 048 010027 00 17	<b>27'lik Antigron Boru Kroşesi</b> Antigron Pipe Straps, Ø27	Kutu Pack	-	-	-
	001 048 010032 00 17	<b>32'lik Antigron Boru Kroşesi</b> Antigron Pipe Straps, Ø32	Kutu Pack	100	0,78 Kg	0,00427
	001 048 010040 00 17	<b>40'lik Antigron Boru Kroşesi</b> Antigron Pipe Straps, Ø40	Kutu Pack	50	0,46 Kg	0,00171

### DÜBELLİ KROŞELER CABLE STRAPS WITH DOWEL

	001 048 090002 00 17	<b>3/13 Tekli Kablo Kroşesi</b> 3/13 Single Cable Strap	Kutu Pack	10000	5,49 Kg	0,03600
	001 048 090006 00 17	<b>8/28 Tekli Kablo Kroşesi</b> 8/28 Single Cable Strap	Kutu Pack	5000	4,98 Kg	0,03500
	001 048 090003 00 17	<b>16'lik Dübelli Boru Kroşesi Tekli</b> Pipe Crochet with Ø16 Dowel, Single	Kutu Pack	3000	4,80 Kg	0,19680
	001 048 090004 00 17	<b>20'lik Dübelli Boru Kroşesi Tekli</b> Pipe Crochet with Ø20 Dowel, Single	Kutu Pack	2000	4,55 Kg	0,03600
	001 048 090005 00 17	<b>25'lik Dübelli Boru Kroşesi Tekli</b> Pipe Crochet with Ø25 Dowel, Single	Kutu Pack	1500	4,49 Kg	0,03645

### PLASTİK DÜBELLER PLASTIC DOWEL

	Kod Code	Açıklama Description	Ambalaj Packing	Adet Quantity	Ağırlık Weight	Hacim Volume
--	-------------	-------------------------	--------------------	------------------	-------------------	-----------------

	016 053 000014	<b>Burgulu Alçıpan Dübeli (Yeni)</b> Twisted Drywall Dowel	Kutu Pack	10000	11 Kg	0,03000
	001 053 000001 00 00	<b>Alçıpan Dübeli</b> Drywall Dowel	Kutu Pack	15000	24 Kg	0,12810
	001 053 000002 00 00	<b>Kanal Dübeli</b> Trunking Dowel	Kutu Pack	14000	22,40 Kg	0,14000
	016 053 000006	<b>6 mm Beyaz Dübül</b> 6 mm Dowel, White	Kutu Pack	35000	28 Kg	0,33075
	016 053 000007	<b>7 mm Beyaz Dübül</b> 7 mm Dowel, White	Kutu Pack	25000	15 Kg	0,05000
	016 053 000008	<b>8 mm Beyaz Dübül</b> 8 mm Dowel, White	Kutu Pack	20000	20 Kg	0,18900

## KROŞELER CABLE STRAPS

	Kod Code	Açıklama Description	Ambalaj Packing	Adet Quantity	Ağırlık Weight	Hacim Volume
--	-------------	-------------------------	--------------------	------------------	-------------------	-----------------

### TANDIR KROŞELER METALLIC CABLE STRAPS

	035 048 110001	<b>No.1 Tandır Kroşe (2x1.5-2x6)</b> No. 1 Metallic Cable Straps	Kutu Pack	350	3,87 Kg	0,00270
	035 048 110002	<b>No.2 Tandır Kroşe (4x6)</b> No. 2 Metallic Cable Straps	Kutu Pack	250	2,16 Kg	0,00275
	035 048 110003	<b>No.3 Tandır Kroşe (4x10)</b> No. 3 Metallic Cable Straps	Kutu Pack	250	1,90 Kg	0,00200
	035 048 110004	<b>No.4 Tandır Kroşe (4x16)</b> No. 4 Metallic Cable Straps	Kutu Pack	150	2,11 Kg	0,00285
	035 048 110005	<b>No.5 Tandır Kroşe (3x25+16)</b> No. 5 Metallic Cable Straps	Kutu Pack	150	2,21 Kg	0,00281

### RAY KROŞELER RAIL CABLE STRAPS

	035 048 100001	<b>No.1 Ray Kroşe (2x1.5-4x2.5)</b> No. 1 Rail Cable Straps	Kutu Pack	350	2,34 Kg	0,00560
	035 048 100002	<b>No.2 Ray Kroşe (4x4-4x16)</b> No. 2 Rail Cable Straps	Kutu Pack	250	2,13 Kg	0,00575
	001 025 010100 00 00	<b>Galvaniz Ray Kroşe</b> Galvanized Rail Cable Straps	Kutu Pack	50	12,50 Kg	0,01270

### GALVANİZ SAC KROŞELER GALVANIZED SHEET CABLE STRAPS

	001 048 060001 00 00	<b>No.1 Tekli</b> No. 1 Single Ø 10 mm	Kutu Pack	1500	6,60 Kg	0,00600
	001 048 060002 00 00	<b>No.2 Tekli</b> No. 2 Single Ø 14 mm	Kutu Pack	1000	6,00 Kg	0,00600
	001 048 060003 00 00	<b>No.3 Tekli</b> No. 3 Single Ø 16 mm	Kutu Pack	700	5,11 Kg	0,00630
	001 048 060004 00 00	<b>No.4 Tekli</b> No. 4 Single Ø 20 mm	Kutu Pack	500	4,25 Kg	0,00600
	001 048 060007 00 00	<b>No.7 Tekli</b> No. 7 Single Ø 25 mm	Kutu Pack	350	3,82 Kg	0,00595
	001 048 060008 00 00	<b>No.8 Tekli</b> No. 8 Single Ø 40 mm	Kutu Pack	250	3,28 Kg	0,00600
	001 048 060009 00 00	<b>No.9 Tekli</b> No. 9 Single Ø 45.5 mm	Kutu Pack	200	2,98 Kg	0,00600
	001 048 060010 00 00	<b>No.10 Tekli</b> No. 10 Single Ø 50.5 mm	Kutu Pack	150	2,31 Kg	0,00600
	001 048 070002 00 00	<b>No.2 Çiftli</b> No. 2 Double Ø 13 mm	Kutu Pack	600	4,85 Kg	0,00600
	001 048 070003 00 00	<b>No.3 Çiftli</b> No. 3 Double Ø 15.5 mm	Kutu Pack	500	4,17 Kg	0,00600
	001 048 070004 00 00	<b>No.4 Çiftli</b> No. 4 Double Ø 22 mm	Kutu Pack	400	3,70 Kg	0,00600
001 048 070007 00 00	<b>No.7 Çiftli</b> No. 7 Double Ø 26 mm	Kutu Pack	400	4,92 Kg	0,00800	
001 048 070008 00 00	<b>No.8 Çiftli</b> No. 8 Double Ø 33 mm	Kutu Pack	300	4,09 Kg	0,00780	
001 048 070009 00 00	<b>No.9 Çiftli</b> No. 9 Double Ø 44 mm	Kutu Pack	200	3,43 Kg	0,00780	
001 048 070010 00 00	<b>No.10 Çiftli</b> No. 10 Double Ø 48 mm	Kutu Pack	150	2,84 Kg	0,00780	
001 048 070011 00 00	<b>No.11 Çiftli</b> No. 11 Double Ø 55.5 mm	Kutu Pack	100	2,08 Kg	0,00600	

## MUTLUSAN BETON ÇİVİLİ KROŞELER

### MUTLUSAN CABLE STRAPS WITH CONCRETE NAIL

	Kod Code	Açıklama Description	Ambalaj Packing	Adet Quantity	Ağırlık Weight	Hacim Volume
	032 048 070000	<b>No.0 Beton Çivili Kroşe</b> <b>0.75 Yassı Kord. Kroşe</b> No. 0 Cable Strap with Concrete Nail 0.75 Flat Cord Cable Strap	Kutu Pack	30000	26,7 Kg	0,060
	032 048 070001	<b>No.1 Beton Çivili Kroşe</b> <b>0.75 Yassı Kord. Kroşe</b> No. 1 Cable Strap with Concrete Nail 0.75 Flat Cord Cable Strap	Kutu Pack	30000	27 Kg	0,060
	032 048 070002	<b>No.2 Beton Çivili Kroşe</b> <b>0.75 Yassı Kord. Kroşe</b> No. 2 Cable Strap with Concrete Nail 0.75 Flat Cord Cable Strap	Kutu Pack	20000	20 Kg	0,028
	032 048 070003	<b>No.3 Beton Çivili Kroşe</b> <b>(2x1.5-3x1.5)</b> No. 3 Cable Strap with Concrete Nail (2x1.5 - 3x1.5)	Kutu Pack	20000	28 Kg	0,060
	032 048 070004	<b>No.4 Beton Çivili Kroşe</b> <b>(2x4)</b> No.4 Cable Strap with Concrete Nail (2x4)	Kutu Pack	20000	30 Kg	0,060
	032 048 070005	<b>No.5 Beton Çivili Kroşe</b> <b>(2x4-4x4)</b> No. 5 Cable Strap with Concrete Nail (2x4-4x4)	Kutu Pack	10000	20 Kg	0,050
	032 048 070006	<b>No.6 Beton Çivili Kroşe</b> <b>(2x6)</b> No. 6 Cable Strap with Concrete Nail (2x6)	Kutu Pack	10000	10 Kg	0,100
	032 048 070007	<b>No.7 Beton Çivili Kroşe</b> <b>(4x10)</b> No. 7 Cable Strap with Concrete Nail (4x10)	Kutu Pack	8000	31,2 Kg	0,080
	032 048 070008	<b>No.8 Beton Çivili Kroşe</b> <b>(3x16+10)</b> No. 8 Cable Strap with Concrete Nail (3x26+10)	Kutu Pack	5000	31 Kg	0,080

## BONCUK ve BURMA TİP KELEPÇELER

### PLASTIC CLIPS & TWIST CLAMPS

	Kod Code	Açıklama Description	Kutu Box	Adet Quantity
	062 129 010101	2x105 Boncuk Kelepçe / Plastic Clips	1	1000
	062 129 010102	3,5x165 Boncuk Kelepçe / Plastic Clips	1	500
	062 129 010104	3,5x235 Boncuk Kelepçe / Plastic Clips	1	100
	060 120 005105	EA.05.105 Burma Kelepçe/ Twist Clamp	1	500
	060 120 007107	EA.07.107 Burma Kelepçe / Twist Clamp	1	500
	060 120 010110	EA.10.110 Burma Kelepçe / Twist Clamp	1	500
	060 120 014114	EA.14.114 Burma Kelepçe / Twist Clamp	1	500
	060 120 017117	EA.17.117 Burma Kelepçe / Twist Clamp	1	500

## ETİKETLER

### LABELS

	Kod Code	Açıklama Description	Kutu Box	Adet Quantity
	062 129 111035	10x35 Kablo Bağı Etiketi / Cable Tie Label	1	100
	062 129 112045	20x45 Kablo Bağı Etiketi / Cable Tie Label	1	100
	062 129 121530	17x30 Yapışkanlı Pano Etiketi / Adhesive Panel Label	1	100
	062 129 121750	17x50 Yapışkanlı Pano Etiketi / Adhesive Panel Label	1	50
	062 129 122075	17x75 Yapışkanlı Pano Etiketi / Adhesive Panel Label	1	25



**ASPIRATÖRLER**  
**FANS****100 mm**

Çalışma Akımı Operation Voltage	220-240V / 50-60Hz
Emiş Hacmi Airflow	100m <sup>3</sup> /h
Devir Hız Round Speed	2450 rpm
Ses Voice	43 dB
Güç Power	12W

KOD / CODE : 001 111 000100 00 00

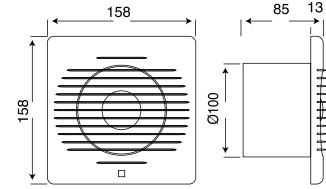
**120 mm**

Çalışma Akımı Operation Voltage	220-240V / 50-60Hz
Emiş Hacmi Airflow	120m <sup>3</sup> /h
Devir Hız Round Speed	1900 rpm
Ses Voice	47 dB
Güç Power	15W

KOD / CODE : 001 111 000120 00 00

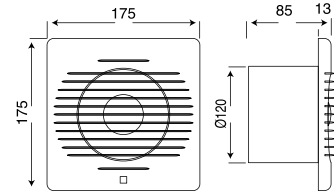
**150 mm**

Çalışma Akımı Operation Voltage	220-240V / 50-60Hz
Emiş Hacmi Airflow	150m <sup>3</sup> /h
Devir Hız Round Speed	1350 rpm
Ses Voice	47 dB
Güç Power	20W

KOD / CODE : 001 111 000150 00 00

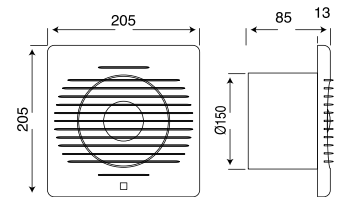
**200 mm**

Çalışma Akımı Operation Voltage	220-240V / 50-60Hz
Emiş Hacmi Airflow	200m <sup>3</sup> /h
Devir Hız Round Speed	1000 rpm
Ses Voice	47 dB
Güç Power	40W

KOD / CODE : 001 111 000200 00 00

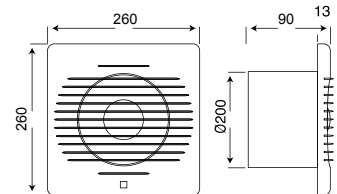



**SANAYİ ÜRÜN GRUBU**  
INDUSTRIAL PRODUCT GROUP





# SANAYİ FİŞ - PRİZ GRUBU

## PLUG - SOCKET GROUP

1x16A MONOFAZE	Kod Code	Açıklama Description	Ambalaj Packing	Adet Quantity	Ağırlık Weight	Hacim Volume
	010 083 300027	<b>MUT-27</b> 1x16 A MONOFAZE TOPRAKLI ERKEK FİŞ (EĞİK) 1x16 A MONOPHASE EARTHED PLUG	Kutu Pack	50	4,000 kg	0,01673
	010 083 300028	<b>MUT-28</b> 1x16 A MONOFAZE TOPRAKLI ERKEK FİŞ (DÜZ) 1x16 A MONOPHASE EARTHED SOCKET	Kutu Pack	50	4,125 kg	0,01673
	010 083 300029	<b>MUT-29</b> 1x16 A MONOFAZE TOPRAKLI DiŞİ FİŞ 1x16 A MONOPHASE EARTHED SOCKET	Kutu Pack	30	6,100 kg	0,01673
	010 083 500296	<b>MUT-29/6</b> 1x16 A MONOFAZE TOPRAKLI DUVAR PRİZİ 1x16 A MONOPHASE EARTHED WALL SOCKET	Kutu Pack	24	2,688 kg	0,01673
	010 083 500292	<b>MUT-29/2</b> 1x16 A MONOFAZE 2'Lİ GRUP PRİZ 1x16 A MONOPHASE 2 GANG GROUP SOCKET	Kutu Pack	12	3,300 kg	0,01673
	010 083 501292	<b>MUT-29/2A</b> 1x16 A MONOFAZE 2'Lİ GRUP PRİZ ANAHTARLI 1x16 A MONOPHASE 2 GANG GROUP SOCKET WITH SWITCH	Kutu Pack	12	3,888 kg	0,01673
	010 083 500293	<b>MUT-29/3</b> 1x16 A MONOFAZE 3'LÜ GRUP PRİZ 1x16 A MONOPHASE 3 GANG GROUP SOCKET	Kutu Pack	12	4,368 kg	0,01673
	010 083 501293	<b>MUT-29/3A</b> 1x16 A MONO. 3'LÜ GRUP PRİZ ANAHTARLI 10/80 1x16 A MONOPHASE 3 GANG GROUP SOCKET WITH SWITCH 10/80	Kutu Pack	10	3,240 kg	0,01673
	010 083 500294	<b>MUT-29/4</b> 1x16 A MONOFAZE 4'LÜ GRUP PRİZ 1x16 A MONOPHASE 4 GANG GROUP SOCKET	Kutu Pack	10	3,640 kg	0,01673

# SANAYİ FİŞ - PRİZ GRUBU

## PLUG - SOCKET GROUP

1x16A MONOFAZE	Kod Code	Açıklama Description	Ambalaj Packing	Adet Quantity	Ağırlık Weight	Hacim Volume
	<b>010 083 500298</b>	MUT-29/8 MONOFAZE TOPRAKLI PANO PRİZİ MON.PHASE EARTHED PANEL SOCKET	Kutu Pack	40	1,954 kg	0,01673
	<b>010 083 501297</b>	MUT-29/8U MONOFAZE UPS TOPRAKLI PANO PRİZİ MON.PHASE EARTHED UPS PANEL SOCKET	Kutu Pack	40	2,200 kg	0,0127
	<b>010 083 500297</b>	MUT-29/7 MONOFAZE DUVAR PRİZİ (PLASTİK) MON.PHASE WALL SOCKET (PLASTIC)	Kutu Pack	30	2,394 kg	0,01673
	<b>010 083 500299</b>	MUT-29/9 MONOFAZE MAKİNA PRİZİ MON.PHASE AUTOMATION SOCKET	Kutu Pack	20	2,564 kg	0,01673
	<b>010 083 502910</b>	MUT-29/10 MONOFAZE DUVAR PRİZİ MON.PHASE WALL SOCKET	Kutu Pack	15	2,723 kg	0,01673

## SANAYİ FİŞ - PRİZ GRUBU

### PLUG - SOCKET GROUP

3x16A TRİFAZE	Kod Code	Açıklama Description	Ambalaj Packing	Adet Quantity	Ağırlık Weight	Hacim Volume
	<b>010 083 400060</b>	MUT-60 3x16 A. TRİFAZE ERKEK FİŞ 3x16 A. THREE PHASE PLUG	Kutu Pack	30	4,650 kg	0,01673
	<b>010 083 400061</b>	MUT-61 3x16 A. TRİFAZE SEYYAR DİŞİ FİŞ 3x16 A. THREE PHASE PORTABLE SOCKET	Kutu Pack	25	4,825 kg	0,01673
	<b>010 083 400062</b>	MUT-62 3x16 A. TRİFAZE DUVAR PRİZİ 3x16 A. THREE PHASE WALL SOCKET	Kutu Pack	20	4,900 kg	0,01673
	<b>010 083 400063</b>	MUT-63 3x16 A. TRİFAZE DUVAR PRİZİ ( PLASTİK) 3x16 A. THREE PHASE WALL SOCKET (PLASTIC)	Kutu Pack	12	2,460 kg	0,01673
	<b>010 083 400064</b>	MUT-64 3x16 A. TRİFAZE MAKİNA PRİZİ ( PLASTİK) 3x16 A. THREE PHASE AUTOMATION SOCKET (PLASTIC)	Kutu Pack	20	3,000 kg	0,01673

# MUTLUSAN CEE NORM SANAYİ TİPİ FİŞ VE PRİZ GRUBU

## PLUG - SOCKET GROUP

CEE NORM	Kod Code	Açıklama Description	Ambalaj Packing	Adet Quantity	Ağırlık Weight	Hacim Volume
	<b>010 083 000516</b>	MUT-101 CEE NORM 5x16 A. DÜZ FİŞ 5x16 A. FLAT PLUG	Kutu Pack	16	2,530 kg	0,0133
	<b>010 083 010516</b>	MUT-102 CEE NORM 5x16 A. UZATMA PRİZİ 5x16 A. EXTENSION PLUG	Kutu Pack	15	3,190 kg	0,0133
	<b>010 083 020516</b>	MUT-103 CEE NORM 5x16 A. MAKİNA PRİZİ 5x16 A. MACHINE SOCKET	Kutu Pack	20	4,030 kg	0,0133
	<b>010 083 030516</b>	MUT-104 CEE NORM 5x16 A. DUVAR PRİZİ 5x16 A. WALL PLUG	Kutu Pack	8	2,100 kg	0,0133
	<b>010 083 000532</b>	MUT-201 CEE NORM 5x32 A. DÜZ FİŞ 5x32 A. FLAT PLUG	Kutu Pack	15	4,010 kg	0,0133
	<b>010 083 010532</b>	MUT-202 CEE NORM 5x32 A. UZATMA PRİZİ 5x16 A. EXTENSION PLUG	Kutu Pack	14	3,750 kg	0,0133
	<b>010 083 020532</b>	MUT-203 CEE NORM 5x32 A. MAKİNA PRİZİ 5x32 A. MACHINE SOCKET	Kutu Pack	14	3,880 kg	0,0133
	<b>010 083 030532</b>	MUT-204 CEE NORM 5x32 A. DUVAR PRİZİ 5x32 A. WALL PLUG	Kutu Pack	8	2,590 kg	0,0133

## SANAYİ FİŞ - PRİZ GRUBU

### PLUG - SOCKET GROUP

3x25A TRİFAZE	Kod Code	Açıklama Description	Ambalaj Packing	Adet Quantity	Ağırlık Weight	Hacim Volume
	010 083 400030	MUT-30 3x25 A. TRİFAZE ERKEK FİŞ 3x25 A. THREE PHASE PLUG	Kutu Pack	30	3,525 kg	0,01673
	010 083 400031	MUT-31 3x25 A. TRİFAZE SEYYAR DIŞI FİŞ 3x25 A. THREE PHASE PORTABLE SOCKET	Kutu Pack	25	4,258 kg	0,01673
	010 083 600315	MUT-31/5 3x25 A. TRİFAZE DUVAR PRİZİ 3x25 A. THREE PHASE WALL SOCKET	Kutu Pack	24	4,140 kg	0,01673
	010 083 400319	MUT- 31/9 3x25 A. TRİFAZE DUVAR PRİZİ ( PLASTİK) 3x25 A. THREE PHASE WALL SOCKET (PLASTIC)	Kutu Pack	15	2,730 kg	0,01673
	010 083 400318	MUT-31/8 3x25 A. TRİFAZE MAKİNA PRİZİ ( PLASTİK) 3x25 A. THREE PHASE AUTOMATION SOCKET (PLASTIC)	Kutu Pack	20	2,530 kg	0,01673
	010 083 600311	MUT-31/1 1 TRİFAZE + 1 MONOFAZE 2'Lİ GRUP PRİZ 1 THREE PHASE + 1 MON.PHASE 2 GANG GROUP SOCKET	Kutu Pack	10	4,050 kg	0,01673
	010 083 600312	MUT-31/2 TRİFAZE 2'Lİ GRUP PRİZ THREE PHASE 2 GANG GROUP SOCKET	Kutu Pack	10	4,670 kg	0,01673
	010 083 600313	MUT-31/3 TRİFAZE 3'LÜ GRUP PRİZ THREE PHASE 3 GANG GROUP SOCKET	Kutu Pack	10	5,750 kg	0,01673

# SANAYİ FİŞ - PRİZ GRUBU







## PLUG - SOCKET GROUP

1x16A MONOFAZE	Kod Code	Açıklama Description	Ambalaj Packing	Adet Quantity	Ağırlık Weight	Hacim Volume
	010 083 600316	MUT-31/6 2 TRİFAZE + 1 MONOFAZE 3'LÜ GRUP PRİZ 2 THREE PHASE + 1 MON.PHASE 3 GANG GROUP SOCKET	Kutu Pack	10	5,390 kg	0,01673
	010 083 600317	MUT-31/7 1 TRİFAZE + 2 MONOFAZE 3'LÜ GRUP PRİZ 1 THREE PHASE + 2 MON.PHASE 3 GANG GROUP SOCKET	Kutu Pack	10	5,740 kg	0,01673
3x32A TRİFAZE	Kod Code	Açıklama Description	Ambalaj Packing	Adet Quantity	Ağırlık Weight	Hacim Volume
	010 083 400070	MUT-70 3x32 A. TRİFAZE ERKEK FİŞ 3x32 A. THREE PHASE PLUG	Kutu Pack	20	4,400 kg	0,01673
	010 083 400071	MUT-71 3x32 A. TRİFAZE SEYYAR DİŞİ FİŞ 3x32 A. THREE PHASE PORTABLE SOCKET	Kutu Pack	15	3,480 kg	0,01673
	010 083 400072	MUT-72 3x32 A. TRİFAZE DUVAR PRİZİ 3x32 A. THREE PHASE WALL SOCKET	Kutu Pack	20	6,100 kg	0,01673
	010 083 400073	MUT-73 3x32 A. TRİFAZE DUVAR PRİZİ ( PLASTİK) 3x32 A. THREE PHASE WALL SOCKET (PLASTIC)	Kutu Pack	12	2,587 kg	0,01673
	010 083 400074	MUT-374 3x32 A. TRİFAZE MAKİNA PRİZİ ( PLASTİK) 3x32 A. THREE PHASE AUTOMATION SOCKET (PLASTIC)	Kutu Pack	20	3,200 kg	0,01673



## SİNYAL VE KUMANDA BUTONLARI

### SIGNAL AND CONTROL BUTTONS

	Kod Code	Açıklama Description	Ambalaj Packing	Adet Quantity	Ağırlık Weight	Hacim Volume	Renk Color
	010 090 010001	<b>10mm Sinyal Armatürü</b> 10mm Signal Luminaire Neon Lamp - <b>220V</b> <b>Silikon Kablolü / Silicon Cable</b>	Kutu Pack	100	400,07 gr	0,0017	<ul style="list-style-type: none"> <li><span style="color: red;">●</span> Kırmızı / Red</li> <li><span style="color: green;">●</span> Yeşil / Green</li> <li><span style="color: yellow;">●</span> Sarı / Yellow</li> <li><span style="color: blue;">●</span> Mavi / Blue</li> <li><span style="color: white;">●</span> Beyaz / White</li> </ul>
	010 090 010005 010 090 010006 010 090 010007	<b>14mm Sinyal Armatürü</b> 14mm Signal Luminaire 12 V - Neon Lamp 24 V 220 V	Kutu Pack	50	250,07 gr	0,0017	<ul style="list-style-type: none"> <li><span style="color: red;">●</span> Kırmızı / Red</li> <li><span style="color: green;">●</span> Yeşil / Green</li> <li><span style="color: yellow;">●</span> Sarı / Yellow</li> <li><span style="color: blue;">●</span> Mavi / Blue</li> <li><span style="color: white;">●</span> Beyaz / White</li> </ul>
	010 090 010008 010 090 010009 010 090 010010	<b>22mm Sinyal Armatürü</b> 22mm Signal Luminaire 12 V - Neon Lamp 24 V 220 V	Kutu Pack	24	348,07 gr	0,0017	<ul style="list-style-type: none"> <li><span style="color: red;">●</span> Kırmızı / Red</li> <li><span style="color: green;">●</span> Yeşil / Green</li> <li><span style="color: yellow;">●</span> Sarı / Yellow</li> <li><span style="color: blue;">●</span> Mavi / Blue</li> <li><span style="color: white;">●</span> Beyaz / White</li> </ul>
	010 090 010004	<b>Ba9s Ledli Işık Söketli Adaptörlü 22mm 220V Sinyal Armatürü</b> 22 mm Ba9s Signal Luminaire with lamp base, LED light socket 220V	Kutu Pack	24	432,07 gr	0,0017	<ul style="list-style-type: none"> <li><span style="color: red;">●</span> Kırmızı / Red</li> <li><span style="color: green;">●</span> Yeşil / Green</li> <li><span style="color: yellow;">●</span> Sarı / Yellow</li> <li><span style="color: blue;">●</span> Mavi / Blue</li> <li><span style="color: white;">●</span> Beyaz / White</li> </ul>
	010 111 070002 010 111 070001 010 111 070004 010 111 070003	<b>Led'li Buzzer</b> Buzzer with LED 24 V 220 V <b>Buzzer</b> Buzzer 24 V 220 V	Kutu Pack	24	444,07 gr 480,07 gr 444,07 gr 480,07 gr	0,0017 0,0017 0,0017 0,0017	
	010 104 000003	<b>SW-AA42</b> 22mm Plastik Yaylı Buton - Stop 22mm Push Button - Off - 1NC	Kutu Pack	10	284,5 gr	0,0009	<ul style="list-style-type: none"> <li><span style="color: red;">●</span> Kırmızı / Red</li> </ul>
	010 104 00000X	<b>SW-AA42</b> 22mm Plastik Yaylı Buton - Start 22mm Push Button - On - 1NO	Kutu Pack	10	284,5 gr	0,0009	<ul style="list-style-type: none"> <li><span style="color: green;">●</span> Yeşil / Green</li> <li><span style="color: yellow;">●</span> Sarı / Yellow</li> <li><span style="color: blue;">●</span> Mavi / Blue</li> <li><span style="color: white;">●</span> Beyaz / White</li> </ul>

## SİNYAL VE KUMANDA BUTONLARI

### SIGNAL AND CONTROL BUTTONS

	Kod Code	Açıklama Description	Ambalaj Packing	Adet Quantity	Ağırlık Weight	Hacim Volume	Renk Color
	010 104 000009	SW-AA4322 22 mm Plastik Yaylı Buton - Stop - 1NC  22 mm Push Button - Stop - 1NC	Kutu Pack	10	240 gr	0,0009	● Kırmızı / Red
	010 104 000010	SW-AA3361 22 mm Plastik Yaylı Buton - Start - 1NO  22 mm Push Button - Start - 1NO	Kutu Pack	10	240 gr	0,0009	● Mavi / Blue
	010 104 000011	SW-AA3351 22 mm Plastik Yaylı Buton - Start  22 mm Push Button - Start - 1NO	Kutu Pack	10	240 gr	0,0009	● Siyah / Black
	010 104 000012	SW-AA3341 22 mm Plastik Yaylı Buton - Start  22 mm Push Button - Start - 1NO	Kutu Pack	10	240 gr	0,0009	● Beyaz / White
	010 104 000013	SW-AA3371 22 mm Plastik Yaylı Buton - Start  22 mm Push Button - Start - 1NO	Kutu Pack	10	240 gr	0,0009	● Sarı / Yellow
	010 104 000014	SW-AA3381 22 mm Plastik Yaylı Buton - Start  22 mm Push Button - Start - 1NO	Kutu Pack	10	240 gr	0,0009	● Beyaz / White

## SİNYAL VE KUMANDA BUTONLARI

### SIGNAL AND CONTROL BUTTONS

	Kod Code	Açıklama Description	Ambalaj Packing	Adet Quantity	Ağırlık Weight	Hacim Volume	Renk Color
	010 104 000015	SW-AL7325 22 mm Plastik İkiz Buton (1NO+1NC)  22 mm LED Double Push Button (1NO+1NC)	Kutu Pack	10	466,5 gr	0,0017	
	010 104 000016	SW-AL7181 22 mm Plastik Alarm Lamba İkiz Buton (1NO+1NO)  22 mm LED Double Push Button (1NO+1NO)	Kutu Pack	10	466,5 gr	0,0017	
	010 104 000017	SW-AL4252 22 mm Plastik Yukarı Aşağı Oklu Ters Yönlü İkiz Buton (1NO+1NO)  22 mm LED Double Push Button (1NO+1NO)	Kutu Pack	10	466,5 gr	0,0017	
	010 104 000018	SW-AL6171 22 mm Plastik Alarm Ortak Oklu İkiz Buton (1NO+1NO)  22 mm LED Double Push Button (1NO+1NO)	Kutu Pack	10	466,5 gr	0,0017	
	010 104 000019	SW-AL6181 22 mm Plastik Lamba Ortak Oklu İkiz Buton (1NO+1NO)  22 mm LED Double Push Button (1NO+1NO)	Kutu Pack	10	466,5 gr	0,0017	
	010 104 000020	SW-AL7425 22 mm Plastik İşaretli İkiz Buton (1NO+1NC)  22 mm LED Double Push Button (1NO+1NC)	Kutu Pack	10	466,5 gr	0,0017	

## SİNYAL VE KUMANDA BUTONLARI

### SIGNAL AND CONTROL BUTTONS

	Kod Code	Açıklama Description	Ambalaj Packing	Adet Quantity	Ağırlık Weight	Hacim Volume	Renk Color
	010 104 000021	SW-AL7525 22 mm Plastik Yazılı Buton (1NO+1NC)  22 mm LED Double Push Button (1NO+1NC)	Kutu Pack	10	466,5 gr	0,0017	
	010 104 000022	SW-AL4151 22 mm Plastik Yukarı Aşağı Oklu Buton (1NO+1NO)  22 mm LED Double Push Button (1NO+1NO)	Kutu Pack	10	466,5 gr	0,0017	
	010 104 000023	SW-AL7465L 22 mm Plastik İkiz Buton Ledli 220V AC/DC (1NO+1NO)  22 mm LED Double Push Button (1NO+1NO) 220V AC/DC	Kutu Pack	10	466,5 gr	0,0017	
	010 104 000024	SW-AL7465-24L 22 mm Plastik İkiz Buton Ledli 24V AC/DC  22 mm LED Double Push Button 24V AC/DC	Kutu Pack	10	466,5 gr	0,0017	
	010 104 000025	SW-AD21 Plastik Kalıcı 0 - 1 Mandal Buton (1NO)  Selector Switch (1NO)	Kutu Pack	10	351,5 gr	0,0017	
	010 104 000026	SW-AD41 Plastik Kayıcı 0 - 1 Mandal Buton (1NO)  Selector Switch (1NO)	Kutu Pack	10	351,5 gr	0,0017	

## SİNYAL VE KUMANDA BUTONLARI

### SIGNAL AND CONTROL BUTTONS

	Kod Code	Açıklama Description	Ambalaj Packing	Adet Quantity	Ağırlık Weight	Hacim Volume	Renk Color
	010 104 000027	SW-AD33 Plastik Kalıcı 2- 0 - 1 Mandal Buton (1NO+1NO)  Selector Switch (1NO + 1NO)	Kutu Pack	10	446,5 gr	0,0017	
	010 104 000028	SW-AD53 Plastik Kayıcı 2- 0 - 1 Mandal Buton (1NO+1NO)  Selector Switch (1NO + 1NO)	Kutu Pack	10	446,5 gr	0,0017	
	010 104 000029	SW-AG21 Plastik Kalıcı 0-1 Anahtarlı Mandal Buton (1NO)  Selector Switch With Key (1NO)	Kutu Pack	10	556,5 gr	0,0017	
	010 104 000030	SW-AG41 Plastik Kayıcı 0-1 Anahtarlı Mandal Buton (1NO)  Selector Switch With Key (1NO)	Kutu Pack	10	556,5 gr	0,0017	
	010 104 000031	SW-AG33 Plastik Kalıcı 2-0-1 Anahtarlı Mandal Buton (1NO+1NO)  Selector Switch With Key (1NO+1NO)	Kutu Pack	10	651,5 gr	0,0017	
	010 104 000032	SW-AG53 Plastik Kayıcı 2- 0 - 1 Mandal Buton (1NO+1NO)  Selector Switch With Key (1NO+1NO)	Kutu Pack	10	651,5 gr	0,0017	

## SİNYAL VE KUMANDA BUTONLARI

### SIGNAL AND CONTROL BUTTONS

	Kod Code	Açıklama Description	Ambalaj Packing	Adet Quantity	Ağırlık Weight	Hacim Volume	Renk Color
	010 104 000037	SW-AC42 22 mm Plastik Kayıcı Mandal Buton (1NC)  22 mm Emergency Stop Button (1NC)	Kutu Pack	10	514 gr	0,0017	● Kırmızı / Red
	010 104 000038	SW-AC42 22 mm Plastik Kayıcı Mandal Buton (1NO)  22 mm Emergency Stop Button(1NO)	Kutu Pack	10	514 gr	0,0017	● Yeşil / Green
	010 104 000039	SW-AC51 22 mm Plastik Kayıcı Mandal Buton (1NO)  22 mm Emergency Stop Button(1NO)	Kutu Pack	10	514 gr	0,0017	● Sarı / Yellow
	010 104 000033	SW-AS142 40mm Kafa Plastik Anahtarlı Mandal Buton - Acil Stop - 1NC  22 mm Emergency Stop With Key Button (1NO)	Kutu Pack	10	511,5 gr	0,0017	
	010 104 000034	SW-AS542E 40mm Kafa Plastik Mandal Buton - Acil Stop Etiketli - 1NC  Emergency Stop Button (1NC)	Kutu Pack	10	479,5 gr	0,0017	
	010 104 000035	SW-AS542 40mm Kafa Plastik Mandal Buton - Acil Stop - 1NC  Emergency Stop Button (1NC)	Kutu Pack	10	476,5 gr	0,0017	

## SİNYAL VE KUMANDA BUTONLARI

### SIGNAL AND CONTROL BUTTONS

	Kod Code	Açıklama Description	Ambalaj Packing	Adet Quantity	Ağırlık Weight	Hacim Volume	Renk Color
	010 104 000036	<b>SW-AS442</b> 30mm Kafa Plastik Mandal Buton - Acil Stop - 1NC  Emergency Stop Button (1NC)	Kutu Pack	10	473,5 gr	0,0017	 Kırmızı / Red
	010 104 000040	<b>SW-AW3475</b> 22mm Ledli Işıklı Yaylı Buton 110-240V AC (1NC)  22mm Push Button Led 110-240V AC (1NC)	Kutu Pack	10	389,5 gr	0,0009	 Kırmızı / Red
	010 104 000041	<b>SW-AW3475</b> 22mm Ledli Işıklı Yaylı Buton 10-30V DC (1NC)  22mm Push Button Led 10-30V DC (1NC)	Kutu Pack	10	389,5 gr	0,0009	 Kırmızı / Red
	010 104 000042	<b>SW-AW3375</b> 22mm Ledli Işıklı Yaylı Buton 110-240V AC (1NO)  22mm Push Button Led 110-240V AC (1NO)	Kutu Pack	10	389,5 gr	0,0009	 Yeşil / Green
	010 104 000043	<b>SW-AW3375-24</b> 22mm Ledli Işıklı Yaylı Buton 10-30V AC (1NO)  22mm Push Button Led 10-30V AC (1NO)	Kutu Pack	10	389,5 gr	0,0009	 Yeşil / Green
	010 104 000044	<b>SW-AW3575</b> 22mm Ledli Işıklı Yaylı Buton 110-240V AC (1NO)  22mm Push Button Led 110-240V AC (1NO)	Kutu Pack	10	389,5 gr	0,0009	 Sarı / Yellow

## SİNYAL VE KUMANDA BUTONLARI

### SIGNAL AND CONTROL BUTTONS

	Kod Code	Açıklama Description	Ambalaj Packing	Adet Quantity	Ağırlık Weight	Hacim Volume	Renk Color
	010 104 000045	SW-AW3575-24 22mm Ledli Işıklı Yaylı Buton 10-30V AC (1NO)  22mm Push Button Led 10-30V AC (1NO)	Kutu Pack	10	389,5 gr	0,0009	● Sarı / Yellow
	010 104 000046	SW-AW3675 22mm Ledli Işıklı Yaylı Buton 110-240V AC (1NO)  22mm Push Button Led 110-240V AC (1NO)	Kutu Pack	10	389,5 gr	0,0009	● Mavi / Blue
	010 104 000047	SW-AW3675-24 22mm Ledli Işıklı Yaylı Buton 10-30V AC (1NO)  22mm Push Button Led 10-30V AC (1NO)	Kutu Pack	10	389,5 gr	0,0009	● Mavi / Blue
	010 104 000054	SW-AK323L Plastik Ledli Kalıcı 1-0-2 Mandal Buton 110-240V AC (2NO)  Led Selector Switch 1-0-2 110-240V AC (2NO)	Kutu Pack	10	521,5 gr	0,0017	● Yeşil / Green
	010 104 000055	SW-AK324L Plastik Ledli Kalıcı 1-0-2 Mandal Buton 110-240V AC (2NC)  Led Selector Switch 1-0-2 110-240V AC (2NO)	Kutu Pack	10	521,5 gr	0,0017	● Kırmızı / Red
	010 104 000056	SW-AK325L Plastik Ledli Kalıcı 1-0-2 Mandal Buton 110-240V AC (2NO)  Led Selector Switch 1-0-2 110-240V AC (2NO)	Kutu Pack	10	521,5 gr	0,0017	● Sarı / Yellow



## SİNYAL VE KUMANDA BUTONLARI

### SIGNAL AND CONTROL BUTTONS

	Kod Code	Açıklama Description	Ambalaj Packing	Adet Quantity	Ağırlık Weight	Hacim Volume	Renk Color
	010 104 000057	SW-AK323-24L Plastik Ledli Kalıcı 1-0-2 Mandal Buton 10-24V AC/ DC (2NO)  Led Selector Switch 1-0-2 10-24V AC/DC (2NO)	Kutu Pack	10	521,5 gr	0,0017	 Yeşil / Green
	010 104 000058	SW-AK324-24L Plastik Ledli Kalıcı 1-0-2 Mandal Buton 10-24V AC/ DC (2NC)  Led Selector Switch 1-0-2 10-24V AC/DC (2NC)	Kutu Pack	10	521,5 gr	0,0017	 Kırmızı / Red
	010 104 000059	SW-AK325-24 Plastik Ledli Kalıcı 1-0-2 Mandal Buton 10-24V AC/ DC (2NO)  Led Selector Switch 1-0-2 10-24V AC/DC (2NO)	Kutu Pack	10	521,5 gr	0,0017	 Sarı / Yellow
	010 104 000048	SW-AK123L Plastik Ledli Kalıcı 0-1 Mandal Buton 110-240V AC (1NO)  Led Selector Switch 0-1 110-240V AC (1NO)	Kutu Pack	10	421,5 gr	0,0017	 Yeşil / Green
	010 104 000049	SW-AK124L Plastik Ledli Kalıcı 0-1 Mandal Buton 110-240V AC (1NC)  Led Selector Switch 0-1 110-240V AC (1NC)	Kutu Pack	10	421,5 gr	0,0017	 Kırmızı / Red
	010 104 000050	SW-AK125L Plastik Ledli Kalıcı 0-1 Mandal Buton 110-240V AC (1NO)  Led Selector Switch 0-1 110-240V AC (1NO)	Kutu Pack	10	421,5 gr	0,0017	 Sarı / Yellow

# SİNYAL VE KUMANDA BUTONLARI

## SIGNAL AND CONTROL BUTTONS

	Kod Code	Açıklama Description	Ambalaj Packing	Adet Quantity	Ağırlık Weight	Hacim Volume	Renk Color
	010 104 000051	SW-AK123-24L Plastik Ledli Kalıcı 0-1 Mandal Buton 10-24V AC/DC (1NO)  Led Selector Switch 0-1 110-240V AC (1NO)	Kutu Pack	10	421,5 gr	0,0017	● Yeşil / Green
	010 104 000052	SW-AK124-24L Plastik Ledli Kalıcı 0-1 Mandal Buton 10-24V AC/DC (1NC)  Led Selector Switch 0-1 110-240V AC (1NC)	Kutu Pack	10	421,5 gr	0,0017	● Kırmızı / Red
	010 104 000053	SW-AK125-24L Plastik Ledli Kalıcı 0-1 Mandal Buton 10-24V AC/DC (1NO)  Led Selector Switch 0-1 110-240V AC (1NO)	Kutu Pack	10	421,5 gr	0,0017	● Sarı / Yellow
	010 104 000064	SW-BA42 22mm Yaylı Buton (1NC)  22mm Push Button (1NC)	Kutu Pack	10	284,5 gr	0,0009	● Yeşil / Green
	010 104 00006X	SW-BA31 22mm Yaylı Buton (1NO)  22mm Push Button (1NO)	Kutu Pack	10	284,5 gr	0,0009	● Yeşil / Green ● Sarı / Yellow ● Mavi / Blue ● Beyaz / White ● Siyah / Black
	010 104 000071	SW-BA4322 22mm İşaretli Yaylı Buton (1NC)  Push Button Mattel Printing (1NC)	Kutu Pack	10	284,5 gr	0,0009	● Kırmızı / Red

## SİNYAL VE KUMANDA BUTONLARI

### SIGNAL AND CONTROL BUTTONS

	Kod Code	Açıklama Description	Ambalaj Packing	Adet Quantity	Ağırlık Weight	Hacim Volume	Renk Color
	010 104 000072	SW-BA3351 22mm İşaretli Yaylı Buton (1NC) Push Button Mattel Printing (1NC)	Kutu Pack	10	284,5 gr	0,0009	● Siyah / Black
	010 104 000073	SW-BA3341 22mm İşaretli Yaylı Buton (1NO) Push Button Mattel Printing (1NO)	Kutu Pack	10	284,5 gr	0,0009	● Beyaz / White
	010 104 000074	SW-BA3361 22mm İşaretli Yaylı Buton (1NO) Push Button Mattel Printing (1NO)	Kutu Pack	10	284,5 gr	0,0009	● Mavi / Blue
	010 104 000075	SW-BA3371 22mm Yaylı Buton (1NO) 22mm Push Button (1NO)	Kutu Pack	10	284,5 gr	0,0009	● Sarı / Yellow
	010 104 000076	SW-BA3381 22mm İşaretli Yaylı Buton (1NO) Push Button Mattel Printing (1NO)	Kutu Pack	10	284,5 gr	0,0009	● Beyaz / White
	010 104 000077	SW-BL7325 22mm Plastik İkiz Buton (1NO+1NC) Double Push Button (1NO+1NC)	Kutu Pack	10	461,5 gr	0,0017	
	010 104 000078	SW-BL7425 22mm Plastik İkiz Buton (1NO+1NC) Double Push Button Printing (1NO+1NC)	Kutu Pack	10	461,5 gr	0,0017	
	010 104 000079	SW-BL7525 22mm Plastik İkiz Buton (1NO+1NC) Double Push Button Printing (1NO+1NC)	Kutu Pack	10	461,5 gr	0,0017	

## SİNYAL VE KUMANDA BUTONLARI

### SIGNAL AND CONTROL BUTTONS

	Kod Code	Açıklama Description	Ambalaj Packing	Adet Quantity	Ağırlık Weight	Hacim Volume	Renk Color
	010 104 000080	SW-BL4151 Plastik Yukarı Aşağı Oklu İkiz Buton (1NO+1NO) Double Push Printing (1NO+1NO)	Kutu Pack	10	461,5 gr	0,0017	
	010 104 000081	SW-BL4252 Plastik Yukarı Aşağı Oklu İkiz Buton (1NO+1NO) Double Push Printing (1NO+1NO)	Kutu Pack	10	461,5 gr	0,0017	
	010 104 000082	SW-BA3361 22mm İşaretli Yaylı Buton (1NO+1NO) Push Button Printing (1NO+ 1NO)	Kutu Pack	10	461,5 gr	0,0017	
	010 104 000083	SW-BA3371 22mm Yaylı Buton (1NO) Push Button Printing (1NO+ 1NO)	Kutu Pack	10	461,5 gr	0,0017	
	010 104 000084	SW-BA3381 22mm İşaretli Yaylı Buton (1NO) Push Button Printing (1NO+ 1NO)	Kutu Pack	10	461,5 gr	0,0017	
	010 104 000085	SW-BL7325 22mm Plastik İkiz Buton 220 V/AC(1NO+1NC) Double Push Button (1NO+1NC)	Kutu Pack	10	461,5 gr	0,0017	
	010 104 000086	SW-BL7425 22mm Plastik İkiz Buton (1NO+1NC) Double Push Button Printing (1NO+1NC)	Kutu Pack	10	461,5 gr	0,0017	

## SİNYAL VE KUMANDA BUTONLARI

### SIGNAL AND CONTROL BUTTONS

	Kod Code	Açıklama Description	Ambalaj Packing	Adet Quantity	Ağırlık Weight	Hacim Volume	Renk Color
	010 104 000087	SW-BD21 0-1 Kalıcı Mandal Buton (1NO) 0-1 Selector Switch (1NO)	Kutu Pack	10	351,5 gr	0,0017	
	010 104 000088	SW-BD41 0-1 Kayıcı Mandal Buton (1NO) 0-1 Selector Switch (1NO)	Kutu Pack	10	351,5 gr	0,0017	
	010 104 000089	SW-BD33 0-1-2 Kalıcı Mandal Buton (1NO+1NO) 0-1-2 Selector Switch (1NO+1NO)	Kutu Pack	10	446,5 gr	0,0017	
	010 104 000090	SW-BD33 0-1-2 Kayıcı Mandal Buton (1NO+1NO) 0-1-2 Selector Switch (1NO+1NO)	Kutu Pack	10	446,5 gr	0,0017	
	010 104 000168	SW-BK123L 0-1 Ledli Işıklı Kalıcı Mandal Buton (1NO) 110-240V AC 0-1 Led Selector Switch (1NO) 110-240V AC	Kutu Pack	10	421,5 gr	0,0017	 Yeşil / Green
	010 104 000169	SW-BK124L 0-1 Ledli Işıklı Kalıcı Mandal Buton (1NC) 110-240V AC 0-1 Led Selector Switch (1NC) 110-240V AC	Kutu Pack	10	421,5 gr	0,0017	 Kırmızı / Red

## SİNYAL VE KUMANDA BUTONLARI

### SIGNAL AND CONTROL BUTTONS

	Kod Code	Açıklama Description	Ambalaj Packing	Adet Quantity	Ağırlık Weight	Hacim Volume	Renk Color
	010 104 000170	SW-BK125L 0-1 Ledli Işıklı Kalıcı Mandal Buton (1NO) 110-240V AC  0-1 Led Selecttor Switch (1NO) 110-240V AC	Kutu Pack	10	421,5 gr	0,0017	● Sarı / Yellow
	010 104 000171	SW-BK123L-24L 0-1 Ledli Işıklı Kalıcı Mandal Buton (1NO) 10-30V AC/DC  0-1 Led Selecttor Switch (1NO) 10-30V AC/DC	Kutu Pack	10	421,5 gr	0,0017	● Yeşil / Green
	010 104 000172	SW-BK124L-24L 0-1 Ledli Işıklı Kalıcı Mandal Buton (1NC) 10-30V AC/DC  0-1 Led Selecttor Switch (1NC) 10-30V AC/DC	Kutu Pack	10	421,5 gr	0,0017	● Kırmızı / Red
	010 104 000173	SW-BK125L-24L 0-1 Ledli Işıklı Kalıcı Mandal Buton (1NC) 10-30V AC/DC  0-1 Led Selecttor Switch (1NC) 10-30V AC/DC	Kutu Pack	10	421,5 gr	0,0017	● Sarı / Yellow
	010 104 000160	SW-BW3475 22mm Ledli Işıklı Yaylı Buton Stop 110-240V AC  Push Button Led 110-240V AC	Kutu Pack	10	389,5 gr	0,0009	● Kırmızı / Red
	010 104 000161	SW-BW3475-24L 22mm Ledli Işıklı Yaylı Buton Stop 10-30V AC/DC  Push Button Led Stop 10-30V AC/DC	Kutu Pack	10	389,5 gr	0,0009	● Kırmızı / Red

## SİNYAL VE KUMANDA BUTONLARI

### SIGNAL AND CONTROL BUTTONS

	Kod Code	Açıklama Description	Ambalaj Packing	Adet Quantity	Ağırlık Weight	Hacim Volume	Renk Color
	010 104 000162	<b>SW-BW3375</b> 22mm Ledli Işıklı Yaylı Buton Start 110-240V AC  Push Button Led Start 110-240V AC	Kutu Pack	10	389,5 gr	0,0009	 Yeşil / Green
	010 104 000163	<b>SW-BW3375-24L</b> 22mm Ledli Işıklı Yaylı Buton Start 10-30V AC/DC  Push Button Led Start 10-30V AC/DC	Kutu Pack	10	389,5 gr	0,0009	 Yeşil / Green
	010 104 000164	<b>SW-BW3575</b> 22mm Ledli Işıklı Yaylı Buton Start 110-240V AC  Push Button Led Start 110-240V AC	Kutu Pack	10	389,5 gr	0,0009	 Sarı / Yellow
	010 104 000165	<b>SW-BW-357524L</b> 22mm Ledli Işıklı Yaylı Buton Start 10-30V AC/DC  Push Button Led Start 10-30V AC/DC	Kutu Pack	10	389,5 gr	0,0009	 Sarı / Yellow
	010 104 000166	<b>SW-BW3675</b> 22mm Ledli Işıklı Yaylı Buton Start 110-240V AC  Push Button Led Start 110-240V AC	Kutu Pack	10	389,5 gr	0,0009	 Mavi / Blue
	010 104 000167	<b>SW-BW-367524L</b> 22mm Ledli Işıklı Yaylı Buton Start 10-30V AC/DC  Push Button Led Start 10-30V AC/DC	Kutu Pack	10	389,5 gr	0,0009	 Mavi / Blue

## SİNYAL VE KUMANDA BUTONLARI

### SIGNAL AND CONTROL BUTTONS

	Kod Code	Açıklama Description	Ambalaj Packing	Adet Quantity	Ağırlık Weight	Hacim Volume	Renk Color
	010 104 000174	SW-BK323L 1-0-2 Plastik Ledli Kalıcı Mandal Buton (2NO) 110-240V AC  1-0-2 Led Selector Switch (2NO) 110-240V AC	Kutu Pack	10	521,5 gr	0,0017	● Yeşil / Green
	010 104 000175	SW-BK324L 1-0-2 Plastik Ledli Kalıcı Mandal Buton (2NC) 110-240V AC  1-0-2 Led Selector Switch (2NC) 110-240V AC	Kutu Pack	10	521,5 gr	0,0017	● Kırmızı / Red
	010 104 000176	SW-BK325L 1-0-2 Plastik Ledli Kalıcı Mandal Buton (2NO) 110-240V AC  1-0-2 Led Selector Switch (2NO) 110-240V AC	Kutu Pack	10	521,5 gr	0,0017	● Sarı / Yellow
	010 104 000177	SW-BK323-24L 1-0-2 Plastik Ledli Kalıcı Mandal Buton (2NO) 10-24V AC/DC  1-0-2 Led Selector Switch (2NO) 10-24V AC	Kutu Pack	10	521,5 gr	0,0017	● Yeşil / Green
	010 104 000178	SW-BK324-24L 1-0-2 Plastik Ledli Kalıcı Mandal Buton (2NC) 10-24V AC/DC  1-0-2 Led Selector Switch (2NC) 110-240V AC	Kutu Pack	10	521,5 gr	0,0017	● Kırmızı / Red
	010 104 000179	SW-BK325-24L 1-0-2 Plastik Ledli Kalıcı Mandal Buton (2NO) 10-24V AC/DC  1-0-2 Led Selector Switch (2NO) 10-24V AC	Kutu Pack	10	521,5 gr	0,0017	● Sarı / Yellow



## BUTON AKSESUARLARI

### BUTTON ACCESSORIES

	Kod Code	Açıklama Description	Ambalaj Packing	Adet Quantity	Ağırlık Weight	Hacim Volume	Renk Color
	010 093 000001	SW-AP2 Buton Koruma Kılıfı (Yaylı Butonlar İçin)  Silicone Dust Cover	Kutu Pack	50	100,04 gr	0,0009	
	010 104 000099	SW-AP4 IP67 İkiz Buton Koruma Kılıfı (Yaylı Butonlar İçin)  Twin Button Protection (For Spring Button)	Kutu Pack	50	250,04 gr	0,0009	
	010 093 000002	SW-BRY Plastik Yazılı Buton Rozeti  Button Label	Kutu Pack	100	150,04 gr	0,0009	
	010 104 000091	SW-BR1 Plastik Buton Rozeti 26x8 Camlı  Plastic Cover Button 26x8	Kutu Pack	100	450,04 gr	0,0009	
	010 104 000092	SW-BR1 Plastik Buton Rozeti 26x8 Camlı  Plastic Cover Button 26x8	Kutu Pack	100	250,04 gr	0,0009	
	010 104 000093	SW-SiE-R Plastik Buton Rozeti 27x12 Camsız  Plastic Cover Button 27x12	Kutu Pack	100	200,04 gr	0,0009	

## BUTON AKSESUARLARI

### BUTTON ACCESSORIES

	Kod Code	Açıklama Description	Ambalaj Packing	Adet Quantity	Ağırlık Weight	Hacim Volume	Renk Color
	010 093 000003	Acil Durdurma Etiketi Emergency Stop Label	Kutu Pack	50	200,04 gr	0,0009	
	010 104 000095	SW-ER60TE Ø60 mm PLastik Acil Durdurma + Emergency Rozeti (Kalın Tip) Laser Baskı Push Button Mattel Printing (1NO)	Kutu Pack	50	300,04 gr	0,0009	
	010 104 000096	SW-ER60EN-Y Ø60 mm Emergency Stop Label	Kutu Pack	50	275,04 gr	0,0009	
	010 090 050008	SW-AKKM Emniyet Basma Düğmesi Muhafaza Emergency Stop Protective Cover	Kutu Pack	50	300,04 gr	0,0009	
	010 104 000101	SW-AKK Acil Stop Koruma Kapağı Emergency Stop Protective Cover	Kutu Pack	50	300,04 gr	0,0009	
	010 104 000102	SW-AKKY Acil Stop Koruma Kapağı Emergency Stop Protective Cover	Kutu Pack	50	300,04 gr	0,0009	
	010 104 000103	SW-ASKK Acil Stop Koruma Kapağı (Yarım Ay Şeklinde) Emergency Stop Protective Cover	Kutu Pack	20	300,04 gr	0,0009	
	010 104 000104	SW-MKKY Mandal Buton Koruma Kapağı Emergency Stop Protective Cover	Kutu Pack	50	300,04 gr	0,0009	

## BUTON AKSESUARLARI

### BUTTON ACCESSORIES

	Kod Code	Açıklama Description	Ambalaj Packing	Adet Quantity	Ağırlık Weight	Hacim Volume	Renk Color
	010 104 000060	SW-BE101 Kontak Blok (NO) Auxiliary Contact (NO)	Kutu Pack	50	551,5 gr	0,0017	
	010 104 000061	SW-BE102 Kontak Blok (NC) Auxiliary Contact (NC)	Kutu Pack	50	551,5 gr	0,0017	
	010 104 000062	SW-BE103 Işık Soketi 10/30 110-240V AC Auxiliary Led Contact (NO)	Kutu Pack	50	501,5 gr	0,0017	
	999 999 995000	22mm Voltmetre Plastik Led Göstergeli 12-500V AC 22 mm Voltmeter Plastic Led Indicator 12-500V AC	Kutu Pack	10	74,5 gr	0,0017	 Yeşil / Green  Kırmızı / Red  Sarı / Yellow
	999 999 995001	22mm Ampermetre Akım Trafolu Pls. Led Gös. 1A-100A AC/60-380V AC 22 mm Ammeter (with current transformer) Plastic Led Indicator 12-500V AC	Kutu Pack	10	74,5 gr	0,0017	 Yeşil / Green  Kırmızı / Red  Sarı / Yellow
	999 999 995002	22mm Volt + Ampermetre Akım Trafolu Pls. Led Gös. 12A-500V AC/1A-100A AC 22 mm Voltmeter+Ammeter (current trans.) Plastic Led Indicator 1A-100A AC	Kutu Pack	10	74,5 gr	0,0017	 Yeşil / Green  Kırmızı / Red  Sarı / Yellow
	010 104 000063	Buton Switch MS-1010 (1NO) Buton Switch (1NO)	Kutu Pack	50	551,5 gr	0,0017	
	010 104 000193	Buton Switch MS-1011 (1NK) Buton Switch (1NK)	Kutu Pack	50	551,5 gr	0,0017	
	010 104 000194	Buton Switch MS-1012 (1NA+1NK) Buton Switch (1NA+1NK)	Kutu Pack	50	551,5 gr	0,0017	
	010 104 000001	Potans 5K MS-22-5K Potans 5K	Kutu Pack	15	-	-	
	010 104 000002	Potans 10K MS-22-10K Potans 10K	Kutu Pack	15	-	-	

# KUTULU MONTAJLI ÜRÜNLER

## BUTTON IN HOIST

	Kod Code	Açıklama Description	Ambalaj Packing	Adet Quantity	Ağırlık Weight	Hacim Volume	Renk Color
	010 104 000120	<b>MS-KK31</b> 1'Lİ KUTULU START BUTONU (1NO) Push Button On in Hoist (1NO)	Kutu Pack	18	1,740 kg	0,0100	● Yeşil / Green
	010 104 000121	<b>MS-KK42</b> 1'Lİ KUTULU STOP BUTONU (1NC) Push Button Off in Hoist (1NC)	Kutu Pack	18	1,740 kg	0,0100	● Kırmızı / Red
	010 104 000122	<b>MS-KK51</b> 1'Lİ KUTULU START BUTONU (1NO) Push Button On in Hoist (1NO)	Kutu Pack	18	1,740 kg	0,0100	● Sarı / Yellow
	010 104 000123	<b>MS-BX71</b> 1'Lİ KUTULU ALARM BUTONU (1NO) Push Button On in Hoist Printing (1NO)	Kutu Pack	18	1,740 kg	0,0100	
	010 104 000124	<b>MS-BX81</b> 1'Lİ KUTULU AYDINLATMA BUTONU (1NO) Push Button On in Hoist Printing (1NO)	Kutu Pack	18	1,740 kg	0,0100	
	010 104 000125	<b>MS-KK7325</b> 1'Lİ KUTULU İKİZ BUTONU (1NO+1NC) Double Push Button On-Off Printing (1NO-1NC)	Kutu Pack	18	2,47 kg	0,0100	
	010 104 000126	<b>MS-KK4151</b> 1'Lİ KUTULU İŞARETLİ İKİZ BUTONU (1NO+1NO) Double Push Button On-Off Printing (1NO-1NO)	Kutu Pack	18	2,47 kg	0,0100	

## KUTULU MONTAJLI ÜRÜNLER

### BUTTON IN HOIST

	Kod Code	Açıklama Description	Ambalaj Packing	Adet Quantity	Ağırlık Weight	Hacim Volume	Renk Color
	010 104 000127	<b>MS-KBZ</b> 1'Lİ KUTULU KABİN ALTI İKAZ LAMBASI BUZZERLİ  Led Buzzer in Hoist	Kutu Pack	18	2,03 kg	0,0100	
	010 090 050009	<b>MS-BX542</b> 1'Lİ KUTULU ACİL STOP BUTONU (1NC)  Emergency Stop in Hoist (1NC)	Kutu Pack	18	2,31 kg	0,0100	
	010 104 000129	<b>MS-BX542E</b> 1'Lİ KUTULU EMERGENCY STOP BUTONU (1NC)  Emergency Stop in Hoist Printing (1NC)	Kutu Pack	18	2,32 kg	0,0100	
	010 104 000130	<b>MS-BX542ASP</b> 1'Lİ KUT. MÜHÜRLÜ TİP KOR. ACİL STOP BUTONU (1NC)  Emergency Stop in Hoist With Protective Cover (1NC)	Kutu Pack	12	1,86 kg	0,0100	
	010 104 000131	<b>MS-BYP3K</b> 1'Lİ KUTULU 3 KADEME BY-PASS ANAHTARI  Key Selector Switch in Hoist	Kutu Pack	12	2,42 kg	0,0100	
	010 104 000132	<b>MS-BYK4K</b> 1'Lİ KUTULU 4 KADEME BY-PASS ANAHTARLI  Key Selector Switch in Hoist	Kutu Pack	12	2,42 kg	0,0100	
	010 104 000133	<b>MS-KANT</b> 1'Lİ KUTULU KAYICI RESET ANAHTARI  Reset Button in Hoist	Kutu Pack	12	1,76 kg	0,0100	

## KUMANDA KUTULARI

### CONTROL BOXES

	Kod Code	Açıklama Description	Ambalaj Packing	Adet Quantity	Ağırlık Weight	Hacim Volume	Renk Color
	010 104 000105	EK0101S EKO 1'LI BOŞ KUMANDA KUTUSU Eko Empty Control Box	Koli Box	90	7,56 kg	0,0359	
	010 104 000106	EK0201S EKO 1'LI KORUMALI BOŞ KUMANDA KUTUSU Eko Protected Control Box	Koli Box	50	5,05 kg	0,0359	
	010 104 000107	EK0301S EKO 1'LI ACİL STOP ETİKETİ KOR.YAZILI KUMANDA KUTUSU Emergency Stop Label Marked Control Box	Koli Box	50	7,10 kg	0,0359	
	010 104 000156	EK0401S EKO 1'LI ACİL STOPLU KUMANDA KUTUSU Emergency Stop Control Box	Koli Box	50	7,10 kg	0,0359	
	010 091 010001	1'LI ETANJ BUTON KUTUSU EUROBOX Hoist 1 Holder	Kutu Pack	24	2,48 kg	0,0100	 Sarı-Siyah / Yellow-Black  Gri-Siyah / Grey-Black
	010 091 010002	2'LI ETANJ BUTON KUTUSU EUROBOX Hoist 2 Holder	Kutu Pack	18	2,55 kg	0,0100	 Sarı-Siyah / Yellow-Black  Gri-Siyah / Grey-Black
	010 091 010003	3'LÜ ETANJ BUTON KUTUSU EUROBOX Hoist 3 Holder	Kutu Pack	12	1,75 kg	0,0100	 Sarı-Siyah / Yellow-Black  Gri-Siyah / Grey-Black
	010 091 010004	4'LÜ ETANJ BUTON KUTUSU EUROBOX Hoist 4 Holder	Kutu Pack	10	2,02 kg	0,0100	 Sarı-Siyah / Yellow-Black  Gri-Siyah / Grey-Black



## KUMANDA KUTULARI

### CONTROL BOXES

	Kod Code	Açıklama Description	Ambalaj Packing	Adet Quantity	Ağırlık Weight	Hacim Volume	Renk Color
	010 104 000114	SW-BX05SB 5'Lİ ETANJ BUTON KUTUSU EUROBOX Hoist 5 Holder	Kutu Pack	8	1,32 kg	0,0100	
	010 104 000115	SW-BX06SB 6'Lİ ETANJ BUTON KUTUSU EUROBOX Hoist 6 Holder	Kutu Pack	8	1,60 kg	0,0100	
	010 104 000116	SW-BX07SB 7'Lİ ETANJ BUTON KUTUSU EUROBOX Hoist 7 Holder	Kutu Pack	6	1,60 kg	0,0100	
	010 104 000117	SW-BX08SB 8'Lİ ETANJ BUTON KUTUSU EUROBOX Hoist 8 Holder	Kutu Pack	6	1,60 kg	0,0100	
	010 104 000118	SW-BX09SB 9'LU ETANJ BUTON KUTUSU EUROBOX Hoist 9 Holder	Kutu Pack	1	312,02 gr	0,0100	
	010 104 000119	SW-BX10SB 10'LU ETANJ BUTON KUTUSU EUROBOX Hoist 10 Holder	Kutu Pack	1	312,02 gr	0,0100	

# KUMANDA KUTULARI



## CONTROL BOXES

	Kod Code	Açıklama Description	Ambalaj Packing	Adet Quantity	Ağırlık Weight	Hacim Volume	Renk Color
	010 104 000134	MS-KYD02 2'LI ASANSÖR KUYU DİBİ BUTON 220V 16A TOP. PRİZ+ACİL STOP BUTON 2 GANG ELEVATOR PIT BUTTON 220 V 16A EARTED SOCKET+EMERGENCY STOP BUTTON	Kutu Pack	9	1,85 kg	0,0100	
	010 104 000135	MS-KYD03 ACİL STOP BUTON + SEÇİCİ BUTON (2NO) 220V 16A TOP. PANO PRİZİ EMERGENCY STOP BUTTON + SELECT BUT. (2NO) 220v 16A EARTED PANEL SOCKET	Kutu Pack	6	1,40 kg	0,0100	
	010 104 000136	MS-KYD04 6'LI ACİL STOP BUT.+2 AD.OKLU BUT. (1NO) 1 İKİZ BUT. ( 2NO) 1 SEÇ.BUT. (2NO) MS-KYD04 6 GANG EMERGENCY STOP BUTTON +2 PIECES OF ARROWED BUT. (1NO) 1 TWIN BUT. (2NO) 1 SELECT BUT.(2NO)	Kutu Pack	5	1,27 kg	0,0100	
	010 104 000137	MS-KYD05 ACİL STOP BUT.+ 2 OKLU BUT.ORTAK OKLU (1NO) SEÇ.BUT.(2NO-1NC) MS-KYD05 EMERGENCY STOP BUT. + 2 ARROWED BUTTON COMMON ARROWED (1NO) SELECT BUTTON (2NO-1NC)	Kutu Pack	4	1,28 kg	0,0100	
	010 104 000138	MS-KYD06 ACİL STOP BUT.+ 2 OKLU BUT.(2NO)1 ORTAK BUT. (1NO) ALARM BUT.+SEÇ.BUT. (2NO-1NC) MS-KYD06 EMERGENCY STOP +2 ARROWED BUT. (2NO) 1 COMMON BUT. (1NO) ALARM BUT. + SEL. BUT. (2NO-1NC)	Kutu Pack	2	566,02 gr	0,0100	
	010 104 000139	KY2-ALR KORUMALI ACİL STOP BUT.(1NC)NO KONTAKLI ALARM BUTONU KOMBİNASYON KY2-ALR (PROTECTED EMERGENCY STOP (1NC) NO CONTACTED ALARM BUTTON COMBINATION	Kutu Pack	10	1,85 kg	0,0100	
	010 104 000140	MS-KY5-24 KOR.ACİL STOP BUT.(1NC)LAMB.VAVİEN (1NO)24V KATTA LED (1NO) ALARM BUT. 16A.KAP.PRİZ Hoist 3 Holder	Kutu Pack	4	1,35 kg	0,0100	
	010 104 000141	MS-KY3 KOR.ACİL STOP BUT.+ ALARM BUT.+16A KAPAKLI PRİZ KOMBİNASYON PROTECTED EMER. STOP BUT. (1NC)LAMP. CONTRACTOR (1NO)24V CATA LED (1NO) ALARM BUT. 16A COVER. SOC	Kutu Pack	5	1,09 kg	0,0100	



## KUMANDA KUTULARI

### CONTROL BOXES

	Kod Code	Açıklama Description	Ambalaj Packing	Adet Quantity	Ağırlık Weight	Hacim Volume	Renk Color
	010 104 000142	MS-KY3ES5012 KOR.ACİL STOP BUT. +ALARM+9V PİLLİ 130 dB KOMBİNASYON MS-KY3ES5012 PROTECTED EMER. STOP+ 9VOLT BATTERY POWERED 130dB ALARM COMBINATION	Kutu Pack	5	1,38 kg	0,0100	
	010 104 000143	MS-KY4ES5012 KOR.ACİL STOP BUT. +9V PİLLİ 130 dB ALARM + 16A KAP. PRİZ KOMBİN. MS-KY4ES5012 PROTECTED EMERGENCY STOP+ 9VOLT BATTERY POW. 130dB ALR. AND 16A COV. SOC. COMB.	Kutu Pack	4	1,14 kg	0,0100	
	010 091 020001	MS-LV4 YUKARI (1NO) AŞAĞI (1NO) 0-1 REVİZYON (1NO) ACİL STOP BUT. (1NC) EL TERMİNALİ (EL KUMANDA) MS-LV4 UP(1NO) DOWN(1NO) 0-1 REVISION (1NO) EMERGENCY STOP (1NC) (REMOTE CONTROL )	Kutu Pack	6	1,40 kg	0,0100	
	010 104 000145	MS-LV5 YUKARI (1NO) ORTAK (1NO) AŞAĞI (1NO) 0-1 REVİZYON (1NO) ACİL STOP BUT.(1NC) 16A KAP. PRİZ EL TERMİNALİ MS-LV5P UP(1NO)COM. (1NO) DOWN(1NO) 0-1 REVISION (1NO) EMER. STOP (1NC) 16A COVERED SOC. (REMOTE CON.)	Kutu Pack	4	1,16 kg	0,0100	
	010 104 000146	MS3BY-BG53P 3KD.BY-PASSLI LAMBA BUT.(1NO) 24V KATTA LEDLİ REG.AÇMA (1NO) 16A KAP.PRİZ KOMBİNASYON MS3BY-BG53P 3KD.BYPASS LAMP BUTTON (1NO) 24V CATA LED REG. ON (1NO) 16A COVERED SOCKET COMB.	Kutu Pack	2	520 gr	0,0100	
	010 104 000147	MS9-BX07 YUKARI (1NO)AŞAĞI (1NO), ORTAK(1NO) 24V KATTA LEDLİ KOR.ACİL STOP(1NC) ALR.(1NO)LAM.(1NO)KOR.0-1REV.(1NO)16A MS9-BX07 UP(1NO) DOWN (1NO) COMMON(1NO) 24V CATA LED PROT. EMER. STOP (1NC) ALARM(1NO) LAMP (1NO) PROT. 0-1 REV. (1NO) 16A	Kutu Pack	1	300,04 gr	0,0100	
	010 104 000148	MS102-ED21 3BY 3KD.BYP REG.KİL.(1NO) REG.AÇ(1NO) 24V KATTA LED FREN AÇMA (1NO) KOR.0-1SET RESET (1NO) MS102-ED21 3BY 3KD.BYP REG.KEY(1NO) REG. ON (1NO) 24V CATA LED BREAK ON (1NO) PROT. 0-1 SET RESET (1NO)	Kutu Pack	1	310 gr	0,0100	
	010 104 000149	MS201-ED21 REG.AÇ KAPA (2NO)24V KATTA LED LAMBA BUT. (1NO) FREN AÇMA1 (1NO) FREN AÇMA2(1NO)KOR.SET RESET (2NO) MS201-ED21 REG.ON / OFF(2NO) 24V CATA LED LAMP BUTTON(1NO) BREAK ON1(1NO) BREAK ON2 (1NO) PROTECTED SET RESET(2NO)	Kutu Pack	3	310 gr	0,0100	



## VİNÇ KUMANDA BUTONLARI

### CRANE CONTROL BUTTONS

	Açıklama Description	Kontak Contact	Ambalaj Packing	Adet Quantity	Ağırlık Weight	Hacim Volume
 010 092 000001	<b>2'li Vinç Kutusu (Tek Hızlı)</b> Crane Box, Double (Single Speed) IP 65	<b>1 N / A</b> 1 N / 0  <b>1 N / K</b> 1 N / C	Kutu Pack	1	400,09 gr	0,00355
 010 092 000002	<b>3'lü Vinç Kutusu (Tek Hızlı)</b> Crane Box, Triple (Single Speed) IP 65	<b>1 N / A</b> 1 N / 0  <b>1 N / K</b> 1 N / C	Kutu Pack	1	480,09 gr	0,00355
 010 092 000003	<b>4'lü Vinç Kutusu (Tek Hızlı)</b> Crane Box, Quadruple (Single Speed) IP 65	<b>1 N / A</b> 1 N / 0  <b>1 N / K</b> 1 N / C	Kutu Pack	1	504,09 gr	0,00355
 010 092 000004	<b>5'li Vinç Kutusu (Tek Hızlı)</b> Crane Box, Quintet (Single Speed) IP 65	<b>1 N / A</b> 1 N / 0  <b>1 N / K</b> 1 N / C	Kutu Pack	1	564,59 gr	0,00355
 010 092 000005	<b>6'li Vinç Kutusu (Tek Hızlı)</b> Crane Box, Sextet (Single Speed) IP 65	<b>1 N / A</b> 1 N / 0  <b>1 N / K</b> 1 N / C	Kutu Pack	1	712,09 gr	0,00355
 010 092 000006	<b>7'li Vinç Kutusu (Tek Hızlı)</b> Crane Box, Septet (Single Speed) IP 65	<b>1 N / A</b> 1 N / 0  <b>1 N / K</b> 1 N / C	Kutu Pack	1	767,09 gr	0,00355

## VİNÇ KUTULARI







### CRANE PUSH BUTTON

	Kod Code	Açıklama Description	Ambalaj Packing	Adet Quantity	Ağırlık Weight	Hacim Volume
	010 104 000142	MS-KY3ES5012 KOR.ACİL STOP BUT. +ALARM+9V PİLLİ 130 dB KOMBİNASYON MS-KY3ES5012 PROTECTED EMER. STOP+ 9VOLT BATTERY POWERED 130dB ALARM COMBINATION	Kutu Pack	5	88,04 gr	0,0009
	010 104 000143	MS-KY4ES5012 KOR.ACİL STOP BUT. +9V PİLLİ 130 dB ALARM + 16A KAP. PRİZ KOMBİN. MS-KY4ES5012 PROTECT- ED EMERGENCY STOP+ 9VOLT BATTERY POW. 130dB ALR. AND 16A COV. SOC. COMB.	Kutu Pack	4	105,04gr	0,0009
	010 091 020001	MS-LV4 YUKARI (1NO) AŞAĞI (1NO) 0-1 REVİZYON (1NO) ACİL STOP BUT. (1NC) EL TERMİNALİ (EL KUMANDA) MS-LV4 UP(1NO) DOWN(1NO) 0-1 REVISION (1NO) EMERGENCY STOP (1NC) (HAND CONTROL )	Kutu Pack	6	127,04 gr	0,0009

## KARE BUATLAR

### SQUARE JUNCTION BOXES

IP40

	001 046 051010 00 12   	Alev Yayımayan 10x10 Kare Buat Turuncu Non Flammable 10x10 Square Junc Orange	Kutu Pack	10	0,833 kg	0,00610
	001 046 021010 00 12	Alev Yayan 10x10 Kare Buat Turuncu Flammable 10x10 Square Junc Orange	Kutu Pack	10	0,833 kg	0,00610
	001 046 051212 00 12   	Alev Yayımayan 12x12 Kare Buat Turuncu Non Flammable 12x12 Square Junc Orange	Kutu Pack	10	1,020 kg	0,00928
	001 046 021212 00 12	Alev Yayan 12x12 Kare Buat Turuncu Flammable 12x12 Square Junc Orange	Kutu Pack	10	1,020 kg	0,00928
	001 046 051515 00 12   	Alev Yayımayan 15x15 Kare Buat Turuncu Non Flammable 15x15 Square Junc Orange	Kutu Pack	10	1,850 kg	0,01509
	001 046 021515 00 12	Alev Yayan 15x15 Kare Buat Turuncu Flammable 15x15 Square Junc Orange	Kutu Pack	10	1,850 kg	0,01509
	001 046 052020 00 12   	Alev Yayımayan 20x20 Kare Buat Turuncu Non Flammable 20x20 Square Junc Orange	Kutu Pack	10	2,829 kg	0,02772
	001 046 022020 00 12	Alev Yayan 20x20 Kare Buat Turuncu Flammable 20x20 Square Junc Orange	Kutu Pack	10	2,857 kg	0,02772

# TERMOPLASTİK BUATLAR

## THERMOPLASTIC JUNCTION BOXES

	Kod Code	Açıklama Description	Ambalaj Packing	Adet Quantity	Ağırlık Weight	Hacim Volume
	Alev Yaymayan Non Flammable  	<b>Ø 90 Termoplastik Buat</b> Ø 90 Thermoplastic Junction Box  <b>IP40</b>	Kutu Pack	108	7,647 kg	0,06858
	<b>001 046 090090 00 17</b>					
	Alev Yaymayan Non Flammable  	<b>85x85x48 Termoplastik Buat</b> 85x85x48 Thermoplastic Junction Box  <b>IP40</b>	Kutu Pack	108	9,288 kg	0,06480
	Alev Yayan Flammable					
<b>001 046 098585 00 17</b>						
	Alev Yaymayan Non Flammable  	<b>80x80x48 Termoplastik 7 Çıkışlı Buat</b> 80x80x48 Thermoplastic Junction Box with 7 outlets  <b>IP40</b>	Kutu Pack	108	9,025 kg	0,06858
	Alev Yayan Flammable					
<b>001 046 098080 00 17</b>						
	Alev Yaymayan Non Flammable  	<b>110x110x74 Termoplastik 8 Çıkışlı Buat</b> 110x110x74 Thermoplastic Junction Box with 8 outlets  <b>IP65</b>	Kutu Pack	40	9,708 kg	0,04840
	Alev Yayan Flammable					
<b>001 046 091010 00 17</b>						
	Alev Yaymayan Non Flammable  	<b>110x180x77 Termoplastik 10 Çıkışlı Buat</b> 110x180x77 Thermoplastic Junction Box with 10 outlets  <b>IP65</b>	Kutu Pack	30	10,908 kg	0,05850
	Alev Yayan Flammable					
<b>001 046 091118 00 17</b>						
	Alev Yaymayan Non Flammable  	<b>180x270x100 Termoplastik 14 Çıkışlı Buat</b> 180x270x100 Thermoplastic Junction Box with 14 outlets  <b>IP65</b>	Kutu Pack	8	6,907 kg	0,04728
	Alev Yayan Flammable					
<b>001 046 091827 00 17</b>						

## TERMOPLASTİK BUATLAR

### THERMOPLASTIC JUNCTION BOXES

	Kod Code	Açıklama Description	Ambalaj Packing	Adet Quantity	Ağırlık Weight	Hacim Volume
	Alev Yaymayan Non Flammable   CE <b>001 046 092698 00 44</b>	<b>138x226x98 Şeffaf Termoplastik Buat</b> 138x226x98 Transparent Thermoplastic Boxes	Kutu Pack	8	4,110 kg	0,03671
	Alev Yayan Flammable <b>001 046 072698 00 44</b>	<b>IP65</b>				
	Alev Yaymayan Non Flammable   CE <b>001 046 096131 00 44</b>	<b>138x226x131 Şeffaf Termoplastik Buat</b> 138x226x131 Transparent Thermoplastic Boxes	Kutu Pack	8	4,565 kg	0,04010
	Alev Yayan Flammable <b>001 046 076131 00 44</b>	<b>IP65</b>				
	Alev Yaymayan Non Flammable   CE <b>001 046 091199 00 44</b>	<b>225x311x99 Şeffaf Termoplastik Buat</b> 225x311x99 Transparent Thermoplastic Boxes	Kutu Pack	4	3,500 kg	0,03238
	Alev Yayan Flammable <b>001 046 071199 00 44</b>	<b>IP65</b>				
	Alev Yaymayan Non Flammable   CE <b>001 046 091130 00 44</b>	<b>225x311x130 Şeffaf Termoplastik Buat</b> 225x311x130 Transparent Thermoplastic Boxes	Kutu Pack	4	4,100 kg	0,04010
	Alev Yayan Flammable <b>001 046 071130 00 44</b>	<b>IP65</b>				
	Alev Yaymayan Non Flammable   CE <b>001 046 092698 00 17</b>	<b>138x226x98 Termoplastik Buat</b> 138x226x98 Thermoplastic Boxes	Kutu Pack	8	3,945 kg	0,02668
	Alev Yayan Flammable <b>001 046 072698 00 17</b>	<b>IP65</b>				
	Alev Yaymayan Non Flammable   CE <b>001 046 096131 00 17</b>	<b>138x226x131 Termoplastik Buat</b> 138x226x131 Thermoplastic Boxes	Kutu Pack	8	4,400 kg	0,03694
	Alev Yayan Flammable <b>001 046 076131 00 17</b>	<b>IP65</b>				
	Alev Yaymayan Non Flammable   CE <b>001 046 091199 00 17</b>	<b>225x311x99 Termoplastik Buat</b> 225x311x99 Thermoplastic Boxes	Kutu Pack	4	3,375 kg	0,03238
	Alev Yayan Flammable <b>001 046 071199 00 17</b>	<b>IP65</b>				
	Alev Yaymayan Non Flammable   CE <b>001 046 091130 00 17</b>	<b>225x311x130 Termoplastik Buat</b> 225x311x130 Thermoplastic Boxes	Kutu Pack	4	3,895 kg	0,03974
	Alev Yayan Flammable <b>001 046 071130 00 17</b>	<b>IP65</b>				
	Alev Yaymayan Non Flammable  CE <b>001 046 098226 00 17</b>	<b>138x226x127 Kombinasyon Kutusu</b> 138x226x127 Combination Box	Kutu Pack	8	5,025 kg	0,03694
	Alev Yayan Flammable <b>001 046 078226 00 17</b>	<b>IP65</b>				
	Alev Yaymayan Non Flammable  CE <b>001 046 095311 00 17</b>	<b>225x311x132 Kombinasyon Kutusu</b> 225x311x132 Combination Box	Kutu Pack	4	4,210 kg	0,04010
	Alev Yayan Flammable <b>001 046 075311 00 17</b>	<b>IP65</b>				

# KOMBİNASYON PANOLARI

## COMBINATION BOARDS

	Kod Code	Açıklama Description	Ambalaj Packing	Adet Quantity	Ağırlık Weight	Hacim Volume	Renk Color
	010 104 000180	<b>MK-325-2</b> 3x25 A 1 ADET ÖN+ 1x16 A 2 ADET YAN MK-325-2 3/25 A. 380V. 1 PCS. FRONT - 1/16A. 220V. 2 PCS. SIDE	Koli Box	4	3,540 kg	0,0353	
	010 104 000181	<b>MK-516-1</b> 5x16 A 1 ADET ÖN+ 1x16 A 1 ADET YAN MK-516-1 5/16 A. 380V. 1 PCS. FRONT - 1/16A. 220V. 1 PCS. SIDE	Kutu Pack	6	-	-	
	010 104 000182	<b>MK-516-2</b> 5x16 A 1 ADET ÖN+ 1x16 A 2 ADET YAN MK-516-2 5/16 A. 380V. 1 PCS. FRONT - 1/16A. 220V. 2 PCS. SIDE	Kutu Pack	4	3,750 kg	0,0351	
	010 104 000183	<b>MK-532-1</b> 5x32 A 1 ADET ÖN+ 1x16 A 1 ADET YAN MK-532-1 5/32 A. 380V. 1 PCS. FRONT - 1/16A. 220V. 1 PCS. SIDE	Kutu Pack	4	-	-	
	010 104 000184	<b>MK-532-2</b> 5x32 A 1 ADET ÖN+ 1x16 A 2 ADET YAN MK-532-2 5/32 A. 380V. 1 PCS. FRONT - 1/16A. 220V. 2 PCS. SIDE	Kutu Pack	4	3,950 kg	0,362	
	010 104 000185	<b>MK-2325-2</b> 3x25 A 2 ADET ÖN+ 1x16 A 2 ADET YAN MK-2325-2 3/25 A. 380V. 2 PCS. FRONT - 1/16A. 220V. 2 PCS. SIDE	Kutu Pack	4	-	-	
	010 104 000186	<b>MK-2516-2</b> 5x16A 2 ADET ÖN+ 1x16 A 2 ADET YAN MK-2516-2 5/16 A. 380V. 2 PCS. FRONT - 1/16A. 220V. 2 PCS. SIDE	Kutu Pack	4	5,960 kg	0,0606	
	010 104 000187	<b>MK-2516-4</b> 5x16 A 2 ADET ÖN+ 1x16 A 4 ADET YAN MK-2516-4 5/16 A. 380V. 2 PCS. FRONT - 1/16A. 220V. 4 PCS. SIDE	Kutu Pack	4	6,560 kg	0,0591	

## KOMBİNASYON PANOLARI

### COMBINATION BOARDS

	Kod Code	Açıklama Description	Ambalaj Packing	Adet Quantity	Ağırlık Weight	Hacim Volume	Renk Color
	010 104 000188	<b>MK-2532-2</b> 5x32 A 2 ADET ÖN+ 1x16 A 2 ADET YAN  MK-2532-2 5/32 A. 380V. 2 PCS. FRONT - 1/16A. 220V. 2 PCS. SIDE	Kutu Pack	4	6,550 kg	0,0585	
	010 104 000189	<b>MK-2532-4</b> 5x32 A 2 ADET ÖN+ 1x16 A 4 ADET YAN  MK-2532-4 5/32 A. 380V. 2 PCS. FRONT - 1/16A. 220V. 4 PCS. SIDE	Kutu Pack	4	-	-	
	010 104 000190	<b>MK-5164-4</b> 5x16A 4 ADET ÖN+ 1x16 A 4 ADET YAN  MK-5164-4 5/16 A. 380V. 4 PCS. FRONT - 1/16A. 220V. 4 PCS. SIDE	Kutu Pack	3	-	-	
	010 104 000191	<b>MK-5324-4</b> 5x32 A 4 ADET ÖN+ 1x16 A 4 ADET YAN  MK-5324-4 5/32 A. 380V. 4 PCS. FRONT - 1/16A. 220V. 4 PCS. SIDE	Kutu Pack	3	-	-	
	010 104 000192	<b>MK-51632-4</b> 5x16A 2 ADET ÖN+5x32 A 2 AD. ÖN+1x16 A 4 ADET YAN  MK-51632-4 5/16 A. 380V. 2 PCS. FRONT+5/32 A. 380V. 2 FRONT -1/16A. 220V. 4 PCS. SIDE	Kutu Pack	3	-	-	
	001 046 075130 00 17	<b>1'Lİ KOMBİNASYON KUTUSU BOŞ 215x130 GRİ</b>  SOCKET DISTRIBUTION BOX (EMPTY)(215X130)	Kutu Pack	10			
	001 046 070220 00 17	<b>2'Lİ KOMBİNASYON KUTUSU BOŞ 290x220 GRİ</b>  SOCKET DISTRIBUTION BOX (EMPTY)(290X220)	Kutu Pack	4			

# SÜPER ETANJ RAKORLAR

## SUPER WATERPROOF CABLE GLANDS











IP68 CE

	Kod Code	Açıklama Description	Kablo Çapı (min.-max.) Cable Diameter (min.-max.)	Ambalaj Packing	Adet Quantity	Ağırlık Weight	Hacim Volume
	010 097 000007	PG-7	3,0 mm - 6,5 mm	Kutu Pack	450	2,700 kg	0,00773
	010 097 000009	PG-9	4,0 mm - 8,0 mm	Kutu Pack	300	2,100 kg	0,00773
	010 097 000011	PG-11	5,0 mm - 10,0 mm	Kutu Pack	200	2,000 kg	0,00773
	010 097 000135	PG-13,5	6,0 mm - 12,0 mm	Kutu Pack	175	2,100 kg	0,00773
	010 097 000016	PG-16	10,0 mm - 14,0 mm	Kutu Pack	125	2,025 kg	0,00773
	010 097 000021	PG-21	13,0 mm - 18,0 mm	Kutu Pack	75	1,725 kg	0,00773
	010 097 000029	PG-29	18,0 mm - 25,0 mm	Kutu Pack	40	1,680 kg	0,00773
	010 097 000036	PG-36	22,0 mm - 32,0 mm	Kutu Pack	20	1,600 kg	0,00773
	010 097 000042	PG-42	32,0 mm - 38,0 mm	Kutu Pack	15	1,395 kg	0,00773
	010 097 000048	PG-48	34,0 mm - 44,0 mm	Kutu Pack	12	1,356 kg	0,00773















## RAY KLEMENSLER

### RAIL TERMINAL BLOCKS

	Açıklama Description	Devre Circuit	Ambalaj Packing	Adet Quantity	Ağırlık Weight	Hacim Volume	Renk Color
	<b>2.5mm<sup>2</sup> Ray Klemens</b> 2.5mm <sup>2</sup> Rail Terminal Blocks  <b>Polyamid 66</b> Polyamide 66		Kutu Pack	100	924,5 gr	0,0017	<ul style="list-style-type: none"> <li><span style="color: red;">●</span> Kırmızı / Red</li> <li><span style="color: green;">●</span> Yeşil / Green</li> <li><span style="color: yellow;">●</span> Sarı / Yellow</li> <li><span style="color: blue;">●</span> Mavi / Blue</li> <li><span style="color: grey;">●</span> Gri / Grey</li> <li><span style="color: black;">●</span> Siyah / Black</li> </ul>
	<b>4mm<sup>2</sup> Ray Klemens</b> 4mm <sup>2</sup> Rail Terminal Blocks  <b>Polyamid 66</b> Polyamide 66		Kutu Pack	100	924,5 gr	0,0017	<ul style="list-style-type: none"> <li><span style="color: red;">●</span> Kırmızı / Red</li> <li><span style="color: green;">●</span> Yeşil / Green</li> <li><span style="color: yellow;">●</span> Sarı / Yellow</li> <li><span style="color: blue;">●</span> Mavi / Blue</li> <li><span style="color: grey;">●</span> Gri / Grey</li> <li><span style="color: black;">●</span> Siyah / Black</li> </ul>
	<b>6mm<sup>2</sup> Ray Klemens</b> 6mm <sup>2</sup> Rail Terminal Blocks  <b>Polyamid 66</b> Polyamide 66		Kutu Pack	100	1,324 kg	0,0201	<ul style="list-style-type: none"> <li><span style="color: red;">●</span> Kırmızı / Red</li> <li><span style="color: green;">●</span> Yeşil / Green</li> <li><span style="color: yellow;">●</span> Sarı / Yellow</li> <li><span style="color: blue;">●</span> Mavi / Blue</li> <li><span style="color: grey;">●</span> Gri / Grey</li> <li><span style="color: black;">●</span> Siyah / Black</li> </ul>
	<b>10mm<sup>2</sup> Ray Klemens</b> 10mm <sup>2</sup> Rail Terminal Blocks  <b>Polyamid 66</b> Polyamide 66		Kutu Pack	100	1,375 kg	0,0201	<ul style="list-style-type: none"> <li><span style="color: red;">●</span> Kırmızı / Red</li> <li><span style="color: green;">●</span> Yeşil / Green</li> <li><span style="color: yellow;">●</span> Sarı / Yellow</li> <li><span style="color: blue;">●</span> Mavi / Blue</li> <li><span style="color: grey;">●</span> Gri / Grey</li> <li><span style="color: black;">●</span> Siyah / Black</li> </ul>
	<b>16mm<sup>2</sup> Ray Klemens</b> 16mm <sup>2</sup> Rail Terminal Blocks  <b>Polyamid 66</b> Polyamide 66		Kutu Pack	30	1,040 kg	0,0017	<ul style="list-style-type: none"> <li><span style="color: red;">●</span> Kırmızı / Red</li> <li><span style="color: green;">●</span> Yeşil / Green</li> <li><span style="color: yellow;">●</span> Sarı / Yellow</li> <li><span style="color: blue;">●</span> Mavi / Blue</li> <li><span style="color: grey;">●</span> Gri / Grey</li> <li><span style="color: black;">●</span> Siyah / Black</li> </ul>

# RAY KLEMENSLER

## RAIL TERMINAL BLOCKS

	Açıklama Description	Devre Circuit	Ambalaj Packing	Adet Quantity	Ağırlık Weight	Hacim Volume	Renk Color
	<b>35mm<sup>2</sup> Ray Klemens</b> 35mm <sup>2</sup> Rail Terminal Blocks <b>Polyamid 66</b> Polyamide 66		Kutu Pack	20	1,274 kg	0,0017	<ul style="list-style-type: none"> <li><span style="color: red;">●</span> Kırmızı / Red</li> <li><span style="color: green;">●</span> Yeşil / Green</li> <li><span style="color: yellow;">●</span> Sarı / Yellow</li> <li><span style="color: blue;">●</span> Mavi / Blue</li> <li><span style="color: grey;">●</span> Gri / Grey</li> <li><span style="color: black;">●</span> Siyah / Black</li> </ul>
	<b>Durdurucu</b> Stopper <b>Polyamid 66</b> Polyamide 66		Kutu Pack	100	1,096 kg	0,0017	<ul style="list-style-type: none"> <li><span style="color: grey;">●</span> Gri / Grey</li> </ul>
	<b>Sigortalı Klemens</b> Fuse Terminal Rail		Kutu Pack	75	1,500 kg	0,0017	<ul style="list-style-type: none"> <li><span style="color: yellow;">●</span> Krem / Cream</li> </ul>
	<b>Yay Baskılı Klemens</b> Rail Terminals (Earthed)		Kutu Pack	100	640,07 gr 760,07 gr 2,094 kg 2,390 kg	0,0017	
	<b>Yazılı Dekafix</b> Dekafix with inscriptions		Kutu Pack	500			
	<b>Yazısız Dekafix</b> Dekafix without inscriptions		Kutu Pack	1			
	<b>Topraklama Ray Klemensi</b> Grounding Rail Terminal Block		Kutu Pack	100 100 30 100 100 100 20	1,324 kg 1,596 kg 1,200 kg 1,324 kg 1,824 kg 1,180 kg	0,0017 0,0201 0,0017 0,0017 0,0201 0,0017	<ul style="list-style-type: none"> <li><span style="color: green;">●</span> Yeşil / Green</li> <li><span style="color: yellow;">●</span> Sarı / Yellow</li> </ul>
	<b>010 094 010001</b> 2,5 mm <b>010 094 010011</b> 4 mm <b>010 094 010012</b> 6 mm <b>010 094 010013</b> 10 mm <b>010 094 010014</b>						
	<b>010 094 010003</b> 2,5/4 mm <b>010 094 010004</b> 6/10 mm <b>010 094 010005</b> 16/35 mm <b>010 094 010008</b> 2,5/4 mm <b>010 094 010009</b> 6/10 mm <b>010 094 010010</b> 16/35 mm						

## SIKMALI TİP KABLO PAPUÇLARI (EKO SERİ)

### CLAMPING TYPE CABLE TERMINAL LUGS (EKO SERIES)

	Kod Code	Açıklama Description	Civata Bolt	Ambalaj Packing	Adet Quantity	Ağırlık Weight	Hacim Volume
	123 037 000016	16 mm <sup>2</sup>	M6	Kutu Pack	500	3,500 kg	0,00140
	123 037 000025	25 mm <sup>2</sup>	M8	Kutu Pack	350	3,150 kg	0,00140
	123 037 000035	35 mm <sup>2</sup>	M8	Kutu Pack	200	3,000 kg	0,00142
	123 037 000050	50 mm <sup>2</sup>	M10	Kutu Pack	150	3,450 kg	0,00143
	123 037 000070	70 mm <sup>2</sup>	M10	Kutu Pack	100	3,000 kg	0,00142
	123 037 000095	95 mm <sup>2</sup>	M12	Kutu Pack	70	2,800 kg	0,00140
	123 037 000120	120 mm <sup>2</sup>	M12	Kutu Pack	50	2,700 kg	0,00143
	123 037 000150	150 mm <sup>2</sup>	M12	Kutu Pack	40	3,400 kg	0,00142
	123 037 000185	185 mm <sup>2</sup>	M16	Kutu Pack	30	3,150 kg	0,00143
	123 037 000240	240 mm <sup>2</sup>	M16	Kutu Pack	24	3,120 kg	0,00143

# STANDART KABLO PABUÇLARI

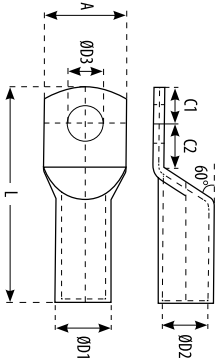

## TIGHTENING TYPE CABLE LUGS (STANDART)

	Kod Code	Açıklama Description	Civata Bolt	D3	D2	D1	DL	A	Kutu /Adet Quantity
	123 037 500010	10-05	M5	5,2	4,7	6,5	27,5	10,5	800
	123 037 500011	10-06	M6	6,5	4,7	6,5	27,5	10,5	800
	123 037 500012	10-08	M8	8,5	4,7	6,5	27,5	10,5	800
	123 037 500016	16-06	M6	6,5	5,8	7,4	30	12	500
	123 037 500017	16-08	M8	8,5	5,8	7,8	30	12	500
	123 037 500024	25-06	M6	6,5	7	9,2	40	14	350
	123 037 500025	25-08	M8	8,5	7	9,2	40	14	350
	123 037 500026	25-10	M10	10,5	7	9,5	40	14	350
	123 037 500034	35-06	M6	6,5	8,2	10,7	44	15,3	200
	123 037 500035	35-08	M8	8,5	8,2	10,7	44	15,3	200
	123 037 500036	35-10	M10	10,5	8,2	10,7	44	15,3	200
	123 037 500037	35-12	M12	13	8,2	10,7	44	15,3	200
	123 037 500049	50-08	M8	8,5	10,2	12,8	52	20	150
	123 037 500050	50-10	M10	10,5	10,2	12,8	52	20	150
	123 037 500051	50-12	M12	13	10,2	12,8	52	20	150
	123 037 500069	70-08	M8	8,5	11,7	14,7	55	22	100
	123 037 500070	70-10	M10	10,5	11,7	14,7	55	22	100
	123 037 500071	70-12	M12	13	11,7	14,7	55	22	100
	123 037 500093	95-08	M8	8,5	13,6	16,7	59	26	70
	123 037 500094	95-10	M10	10,5	13,6	16,7	59	26	70
	123 037 500095	95-12	M12	13	13,6	16,7	59	26	70
	123 037 500119	120-10	M10	10,5	15,5	19	70	29	50
	123 037 500120	120-12	M12	13	15,5	19	70	29	50
	123 037 500149	150-10	M10	10,5	16,7	21	77	32	40
	123 037 500150	150-12	M12	13	16,7	21	77	32	40
	123 037 500183	185-10	M10	10,5	18,8	23	85	35	30
	123 037 500184	185-12	M12	13	18,8	23	85	35	30
	123 037 500185	185-16	M16	17	18,8	23	85	35	30
	123 037 500238	240-10	M10	10,5	21,2	26	90	38,5	24
	123 037 500239	240-12	M12	13	21,2	26	90	38,5	24
	123 037 500240	240-16	M16	17	21,2	26	90	38,5	24
	123 037 500299	300-12	M12	13	23,5	28,6	100	43	20
	123 037 500300	300-16	M16	17	23,5	28,6	100	43	20
	123 037 500400	400-12	M12	13	26,8	32,8	108	48	12
	123 037 500401	400-16	M16	17	26,8	32,8	108	48	12
	123 037 500402	400-20	M20	21	26,8	32,8	108	48	12



## SIRA KLEMENSLER

### CONNECTOR (TERMINAL BLOCKS)

	Kod Code	Açıklama Description	Ambalaj Packing	Adet Quantity	Ağırlık Weight	Hacim Volume
	015 094 150001	<b>Plastik Sıra Klemens No:2 (2.5-4mm<sup>2</sup>)</b> Plastic Wire Connector No: 2 (2.5-4 mm <sup>2</sup> )	Kutu Pack	50	1,500 kg	0,00500
	015 094 150002	<b>Plastik Sıra Klemens No:2 (4-6mm<sup>2</sup>)</b> Plastic Wire Connector No: 2 (4-6 mm <sup>2</sup> )	Kutu Pack	50	2,200 kg	0,00363
	015 094 150003	<b>Plastik Sıra Klemens No:3 (10-16mm<sup>2</sup>)</b> Plastic Wire Connector No: 2 (10-16 mm <sup>2</sup> )	Kutu Pack	50	3,000 kg	0,00499
	015 094 150004	<b>Plastik Sıra Klemens No:4 (16-25mm<sup>2</sup>)</b> Plastic Wire Connector No: 2 (16-25 mm <sup>2</sup> )	Kutu Pack	50	3,650 kg	0,00585
	015 094 170001	<b>Isıya Dayanıklı Sıra Klemens No:1 (2.5-4mm<sup>2</sup>)</b> Fire-Proof Wire Connector No: 2 (2.5-4 mm <sup>2</sup> )	Kutu Pack	50	1,600 kg	0,00500
	015 094 170002	<b>Isıya Dayanıklı Sıra Klemens No:2 (4-6mm<sup>2</sup>)</b> Fire-Proof Wire Connector No: 2 (4-6 mm <sup>2</sup> )	Kutu Pack	50	2,300 kg	0,00500
	015 094 170003	<b>Isıya Dayanıklı Sıra Klemens No:3 (10-16mm<sup>2</sup>)</b> Fire-Proof Wire Connector No: 2 (10-16 mm <sup>2</sup> )	Kutu Pack	50	3,150 kg	0,00500
	015 094 170004	<b>Isıya Dayanıklı Sıra Klemens No:4 (16-25mm<sup>2</sup>)</b> Fire-Proof Wire Connector No: 2 (16-25 mm <sup>2</sup> )	Kutu Pack	50	4,000 kg	0,00500

## KOMBİNASYON PANOLARI

### COMBINATION BOARDS

	Kod Code	Açıklama Description	Kutu Box	Adet Quantity
--	-------------	-------------------------	-------------	------------------

#### GEÇMELİ BUAT KLEMENS

##### PLUGGABLE JUNCTION TERMINALS



999 094 225000	2'Lİ - 2 GANG (0,5-4 mm <sup>2</sup> )	1	100
999 094 325000	3'LÜ - 3 GANG (0,5-4 mm <sup>2</sup> )	1	100
999 094 425000	4'LÜ - 4 GANG (0,5-4 mm <sup>2</sup> )	1	100
999 094 525000	5'Lİ - 5 GANG (0,5-4 mm <sup>2</sup> )	1	100

#### TIRNAKLI BUAT KLEMENS

##### SPIKED JUNCTION TERMINALS



999 094 241000	2'Lİ - 2 GANG (0,5-2,5 mm <sup>2</sup> )	1	100
999 094 341000	3'LÜ - 3 GANG (0,5-2,5 mm <sup>2</sup> )	1	100
999 094 541000	5'Lİ - 5 GANG (0,5-2,5 mm <sup>2</sup> )	1	100

#### ŞEFFAF ISIYA DAYANIKLI BUAT KLEMENS

##### TRANSPARENT HEAT RESISTANT JUNCTION TERMINALS



888 094 000105	NO.2	1	560
888 094 000205	NO.3	1	360
888 094 000405	NO.4	1	300
888 094 000605	NO.5	1	160

#### GEÇMELİ SOKET KLEMENS

##### PLUGGABLE JUNCTION TERMINALS



991212 999 999	12'Lİ - 12 GANG	1	25
----------------	-----------------	---	----

#### PORSELEN KLEMENSLER

##### PORCELAIN TERMINALS



015 094 180002	NO. 1-2'Lİ - (2,5-4 mm <sup>2</sup> )	1	300
015 094 180003	NO. 1-3'LÜ - (2,5-4 mm <sup>2</sup> )	1	220
015 094 180004	NO. 2-2'Lİ - (4-6 mm <sup>2</sup> )	1	200
015 094 180005	NO. 2-3'LÜ - (4-6 mm <sup>2</sup> )	1	177
015 094 180006	NO. 3-2'Lİ - (6-10 mm <sup>2</sup> )	1	104
015 094 180007	NO. 3-3'LÜ - (6-10 mm <sup>2</sup> )	1	64

#### U KLEMENSLER

##### U TERMINALS



014 094 030006	6'LİK - 6 GANG	1	300
014 094 030010	10'LÜK - 10 GANG	1	250
014 094 030016	16'LİK - 16 GANG	1	100
014 094 030025	25'LİK - 25 GANG	1	100
014 094 030035	35'LİK - 35 GANG	1	75
014 094 030050	50'LİK - 50 GANG	1	50
014 094 030070	70'LİK - 70 GANG	1	40
014 094 030095	95'LİK - 95 GANG	1	25
014 094 030120	120'LİK - 120 GANG	1	20

## KABLO BAĞLANTI EKİPMANLARI

### CABLE CONNECTION EQUIPMENTS

	Kod Code	Açıklama Description	Kutu Box	Adet Quantity
--	-------------	-------------------------	-------------	------------------

#### İZOLELİ TEK GİRİŞLİ YÜKSÜK

##### ISOLATED SINGLE INPUT THIMBLE



014 100 010508	ITY-0508 - 0,50 mm	1	1000
014 100 017508	ITY-7508 - 0,75 mm	1	1000
014 100 011008	ITY-1008 - 1,00 mm	1	1000
014 100 011508	ITY-1508 - 1,50 mm	1	1000
014 100 012508	ITY-2508 - 2,50 mm	1	500
014 100 014009	ITY-4009 - 4,00 mm	1	500
014 100 016012	ITY-6012 - 6,00 mm	1	250
014 100 011012	ITY-1012 - 10,00 mm	1	100
014 100 011612	ITY-1612 - 16,00 mm	1	100
014 100 012516	ITY-2516 - 25,00 mm	1	50
014 100 013516	ITY-3516 - 35,00 mm	1	50
014 100 015020	ITY-5020 - 50,00 mm	1	25

#### İZOLELİ ÇİFT GİRİŞLİ YÜKSÜK

##### ISOLATED DOUBLE INPUT THIMBLE



014 100 020508	ICY-0508 - 2x0,5 mm	1	1000
014 100 027508	ICY-7508 - 2x0,75 mm	1	500
014 100 021008	ICY-1008 - 2x1 mm	1	500
014 100 021508	ICY-1508 - 2x1,5 mm	1	500
014 100 022510	ICY-2510 - 2x2,5 mm	1	250
014 100 024012	ICY-4012 - 2x4 mm	1	200
014 100 026014	ICY-6014 - 2x6 mm	1	100

#### İZOLELİ YUVARLAK TİP PAPUÇ

##### ISOLATED CIRCULAR TYPE LUG



014 100 030154	IYP-1,5-4 - 0,5-1,5 mm (M4)	1	200
014 100 030155	IYP-1,5-5 - 0,5-1,5 mm(M5)	1	200
014 100 030156	IYP-1,5-6 - 0,5-1,5 mm(M6)	1	200
014 100 030158	IYP-1,5-8 - 0,5-1,5 mm(M8)	1	200
014 100 030254	IYP-2,5-4 - 1,5-2,5 mm (M4)	1	200
014 100 030255	IYP-2,5-5 - 1,5-2,5 mm(M5)	1	200
014 100 030256	IYP-2,5-6 - 1,5-2,5 mm(M6)	1	200
014 100 030258	IYP-2,5-8 - 1,5-2,5 mm(M8)	1	200
014 100 036004	IYP-6-4 / 4-6 mm(M4)	1	100
014 100 036005	IYP-6-5 / 4-6 mm(M5)	1	100
014 100 036006	IYP-6-6 / 4-6 mm (M6)	1	100
014 100 036008	IYP-6-8 / 4-6 mm(M8)	1	100

#### İZOLELİ ÇATAL TİP PAPUÇ

##### ISOLATED FORK TYPE LUG



014 100 040154	ICP-1,5-4 / 0,5-1,5 mm(M4)	1	200
014 100 040155	ICP-1,5-5 / 0,5-1,5 mm(M5)	1	200
014 100 040156	ICP-1,5-6 / 0,5-1,5 mm(M6)	1	200
014 100 040254	ICP-2,5-4 / 0,5-1,5 mm(M4)	1	200
014 100 040255	ICP-2,5-5 / 0,5-1,5 mm(M5)	1	200
014 100 040256	ICP-2,5-6 / 0,5-1,5 mm(M6)	1	200
014 100 046004	ICP-6-4 / 4-6 mm(M4)	1	100
014 100 046005	ICP-6-5 / 4-6 mm(M5)	1	100
014 100 046006	ICP-6-6 / 4-6 mm(M6)	1	100

## KABLO BAĞLANTI EKİPMANLARI

### CABLE CONNECTION EQUIPMENTS

	Kod Code	Açıklama Description	Kutu Box	Adet Quantity
--	-------------	-------------------------	-------------	------------------

#### İZOLELİ İĞNE TİP TERMİNAL

##### ISOLATED NEEDLE TYPE TERMINAL



014 100 050015	IIT-1,5 / 0,5-1,5 mm	1	200
014 100 050025	IIT-2,5 / 1,5-2,5 mm	1	200
014 100 050040	IIT-4 / 1,5-6 mm	1	100

#### İZOLELİ EK MUF

##### ISOLATED ADDITIONAL PIPE SOCKET



014 100 070015	IEM-1,5 / 0,5-1,5 mm	1	100
014 100 070025	IEM-2,5 / 1,5-2,5 mm	1	100
014 100 070040	IEM-4 / 1,5-6 mm	1	100

#### İZOLELİ FASTON ERKEK TERMİNAL

##### ISOLATED MALE TERMINAL



014 100 060015	IFE-1,5 / 1,5 mm	1	200
014 100 060025	IFE-2,5 / 2,5 mm	1	200
014 100 060040	IFE-4 / 4 mm	1	200

#### İZOLELİ FASTON DIŞI TERMİNAL

##### ISOLATED FEMALE TERMINAL



014 100 080510	IDT-0,5-1 / 0,5-1 mm	1	200
014 100 081525	IDT-1,5-2,5 / 1,5-2,5 mm	1	200
014 100 084060	IDT-4-6 / 4-6 mm	1	200

#### TAM İZOLELİ DIŞI TERMİNAL

##### FULL ISOLATED FEMALE TERMINAL



014 100 090510	TDT-0,5-1 mm	1	100
014 100 091525	TDT-1,5-2,5 mm	1	100
014 100 094060	TDT-4-6 mm	1	100

#### YUVARLAK DIŞI TERMİNAL

##### CIRCULAR FEMALE TERMINAL



014 100 100510	YDT-0,5-1 / 0,5-1 mm	1	200
014 100 101525	YDT-1,5-2,5 / 1,5-2,5 mm	1	100
014 100 104060	YDT-4-6 / 4-6 mm	1	100

#### YUVARLAK ERKEK TERMİNAL

##### CIRCULAR MALE TERMINAL



014 100 110510	YET-0,5-1 / 0,5-1 mm	1	200
014 100 111525	YET-1,5-2,5 / 1,5-2,5 mm	1	200
014 100 114060	YET-4-6 / 4-6 mm	1	200

#### FASTON TİP TERMİNALLER İZOLESİZ

##### FASTON TYPE TERMINAL NON ISOLATED



065 100 140003	TSF-1-D 6,3	1	300
065 100 140002	TSF-1-D MİNİ 4,8	1	200
065 100 140004	TSF-1-E	1	300



## RAYLAR, TOPRAKLAMA ÇUBUĞU VE BARALAR

### RAILS, GROUNDING ROD AND BUSBARS

	Kod Code	Açıklama Description	Ambalaj Packing	Adet Quantity	Ağırlık Weight	Hacim Volume
	001 025 020100 00 00	<b>Klemens Rayı 1 mt.</b> Wire Connector Rail, 1 m	Kutu Pack	25	13,375 kg	0,00635
	001 025 000100 00 00	<b>W Otomat Rayı 1 mt.</b> Fuse Box Rail, 1 m	Kutu Pack	50	15,750 kg	0,01500
	001 025 000033 00 00	<b>W Otomat Rayı 33 cm.</b> Fuse Box Rail, 33 cm	Kutu Pack	50	6,358 kg	0,00500
	001 025 900100 00 00	<b>W Otomat Rayı (Delikli) 1 mt.</b> Fuse Box Rail (Slotted) 1 m	Kutu Pack	50	15,750 kg	0,01500
	034 025 100001	<b>Topraklama Barası Mesnedi</b> Earthing Rod	Kutu Pack	100		
	034 025 040001	<b>Topraklama Barası 1 mt. Kalınlık 1mm</b> Earthing Rod 1m thickness 1 mm	Kutu Pack	40	14,400 kg	0,01200
	034 025 040003	<b>Mono.Müşterek Bara İğne Uçlu 53 cm</b> Mono-phase Common Busbar, Pintle Type, 53 cm.	Kutu Pack	24		
	034 025 040004	<b>Trif. Müşterek Bara İğne Uçlu 53 cm 80A</b> Three-phase Common Busbar, Pintle Type, 53 cm 80A	Kutu Pack	24	6,422 kg	0,00720
	034 025 040005	<b>Trif.Müşterek Bara İğne Uçlu 53 cm / 63A</b> Three-phase Common Busbar, Pintle Type, 53 cm 63A	Kutu Pack	24		
	034 025 040006	<b>Trif.Müşterek Bara İğne Uçlu 106 cm / 80A</b> Three-phase Common Busbar, Pintle Type, 106 cm. 80A	Kutu Pack	24		
	034 025 040007	<b>Trif.Müşterek Bara İğne Uçlu 106 cm / 63A</b> Three-phase Common Busbar, Pintle Type, 106 cm. 63A	Kutu Pack	24		
	034 025 040002	<b>Mon. Müşterek Bara İğne Uçlu 1 mt.</b> Three-phase Common Busbar, Pintle Type, 1m	Kutu Pack	50	10,920 kg	0,01030



**AYDINLATMA GRUBU**  
LIGHTING GROUP

**MINİ**Tavan Glob Armatür  
Ceiling Globe Lighting Fixture

Ürün Kodu / Product Code  
016 038 250031

CE

E27 MAX. 1x75W - 230 V ~ 50 Hz IP20

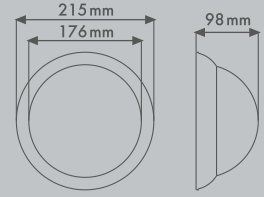

Ambalaj Şekli / Package Type	Kutu / Pack	Ağırlık / Weight	11,71 Kg
Adet / Quantity	48	m <sup>3</sup> / Volume	0,15101

**YASEMİN**Ufo Küre Tavan Armatürü  
Ufo Globe Ceiling Lighting Fixture

Ürün Kodu / Product Code  
001 038 050101 00 00



CLASS II IP20



E27 MAX. 1x60W - 230 V ~ 50 Hz

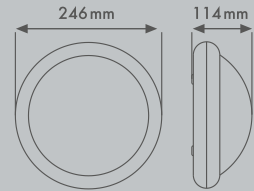

Ambalaj Şekli / Package Type	Kutu / Pack	Ağırlık / Weight	4,80 Kg
Adet / Quantity	12	m <sup>3</sup> / Volume	0,06120

**YASEMİN**Ufo Düz Tavan Armatürü  
Ufo Flat Ceiling Lighting Fixture

Ürün Kodu / Product Code  
001 038 070101 00 00



CLASS II IP20



E27 MAX. 1x60W - 230 V ~ 50 Hz

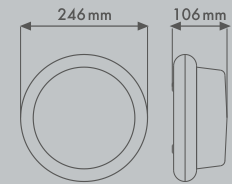

Ambalaj Şekli / Package Type	Kutu / Pack	Ağırlık / Weight	5,40 Kg
Adet / Quantity	12	m <sup>3</sup> / Volume	0,06120

**YASEMİN**Küre Tavan Armatürü  
Globe Ceiling Lighting Fixture

Ürün Kodu / Product Code  
001 038 060101 00 00



CLASS I IP20



E27 MAX. 1x60W - 230 V ~ 50 Hz

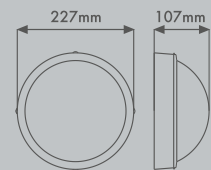

Ambalaj Şekli / Package Type	Kutu / Pack	Ağırlık / Weight	6,00 Kg
Adet / Quantity	12	m <sup>3</sup> / Volume	0,05630



## YASEMİN

Düz Tavan Armatürü  
Flat Ceiling Lighting Fixture

Ürün Kodu / Product Code  
001 038 030101 00 00



CLASS I IP20

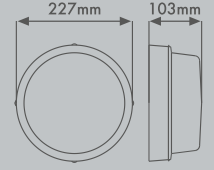

E27 MAX. 1x60W - 230 V ~ 50 Hz

Ambalaj Şekli / Package Type	Kutu / Pack	Ağırlık / Weight	6,50 Kg
Adet / Quantity	12	m <sup>3</sup> / Volume	0,05630



## YASEMİN

Ufo Tavan Armatürü  
Ufo Ceiling Lighting Fixture

Ürün Kodu / Product Code  
001 038 040101 00 00



CLASS II IP20

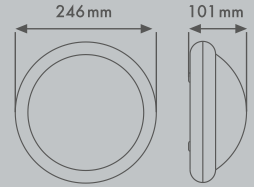

E27 MAX. 1x60W - 230 V ~ 50 Hz

Ambalaj Şekli / Package Type	Kutu / Pack	Ağırlık / Weight	5,20 Kg
Adet / Quantity	12	m <sup>3</sup> / Volume	0,06120



## ORKİDE

Tavan Armatürü  
Ceiling Lighting Fixture

Ürün Kodu / Product Code  
001 038 120101 00 00

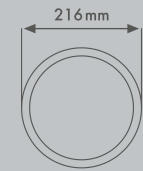

E27 MAX. 1x60W - 230 V ~ 50 Hz

Ambalaj Şekli / Package Type	Kutu / Pack	Ağırlık / Weight	12,48 Kg
Adet / Quantity	48	m <sup>3</sup> / Volume	0,15101



## YONCA

Tavan Armatürü  
Lighting Fixture

Ürün Kodu / Product Code  
001 038 160101 00 00



CLASS I IP20

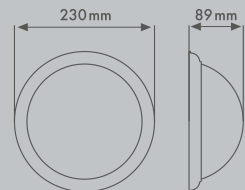

E27 MAX. 1x60W - 230 V ~ 50 Hz

Ambalaj Şekli / Package Type	Kutu / Pack	Ağırlık / Weight	6,93 Kg
Adet / Quantity	16	m <sup>3</sup> / Volume	0,06580

**OVAL****Düz Armatür**  
Antigran Lighting FixtureÜrün Kodu / Product Code  
016 038 250028

E27 MAX. 1x60W - 230 V ~ 50 Hz IP20

Ambalaj Şekli / Package Type Kutu / Pack

Adet / m / Quantity / m 48

Ağırlık / Weight 15.77 kg

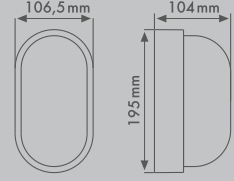
m<sup>3</sup> / Volume 0.138**OVAL****Kafesli Armatür**  
Oval Antigran Lighting FixtureÜrün Kodu / Product Code  
016 038 250029

E27 MAX. 1x60W - 230 V ~ 50 Hz IP20

Ambalaj Şekli / Package Type Kutu / Pack

Adet / m / Quantity / m 48

Ağırlık / Weight 16.47 kg

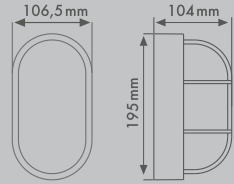
m<sup>3</sup> / Volume 0.138**BEGONYA**  
Nemliyer Waterproff**Tavan ve Duvar Armatürü (Dikey)**  
Ceiling & Wall Lighting Fixture (Vertical)Ürün Kodu / Product Code  
001 038 130101 00 00  

E27 MAX. 1x60W - 230 V ~ 50 Hz

Ambalaj Şekli / Package Type Kutu / Pack

Adet / m / Quantity / m 12

Ağırlık / Weight 4.68 kg

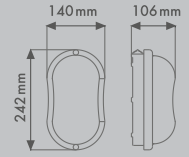
m<sup>3</sup> / Volume 0.043**BEGONYA**  
Nemliyer Waterproff**Tavan ve Duvar Armatürü (Yatay)**  
Ceiling & Wall Lighting Fixture (Horizontal)Ürün Kodu / Product Code  
001 038 140101 00 00  

E27 MAX. 1x60W - 230 V ~ 50 Hz

Ambalaj Şekli / Package Type Kutu / Pack

Adet / m / Quantity / m 12

Ağırlık / Weight 4.69 kg

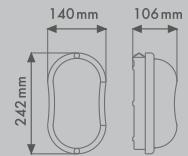
m<sup>3</sup> / Volume 0.043**BEGONYA**  
Nemliyer Waterproff**Tavan ve Duvar Armatürü (Klasik)**  
Ceiling & Wall Lighting Fixture (Classic)Ürün Kodu / Product Code  
001 038 150101 00 00  

E27 MAX. 1x60W - 230 V ~ 50 Hz

Ambalaj Şekli / Package Type Kutu / Pack

Adet / m / Quantity / m 12

Ağırlık / Weight 4.67 kg

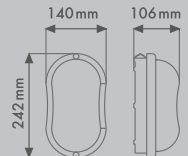
m<sup>3</sup> / Volume 0.043



## FULYA

Aplik  
Wall Lamp

Ürün Kodu / Product Code  
001 038 020201 00 00



CLASS I IP20

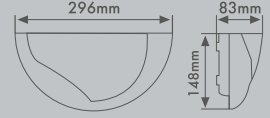

E27 MAX. 1x60W - 230 V ~ 50 Hz

Ambalaj Şekli / Package Type	Kutu / Pack	Ağırlık / Weight	7,00 Kg
Adet / Quantity	20	m <sup>3</sup> / Volume	0,05018



## MANOLYA

Aplik  
Wall Lamp

Ürün Kodu / Product Code  
001 038 010201 00 00



CLASS I IP20

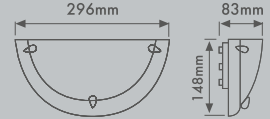

E27 MAX. 1x60W - 230 V ~ 50 Hz

Ambalaj Şekli / Package Type	Kutu / Pack	Ağırlık / Weight	6,00 Kg
Adet / Quantity	20	m <sup>3</sup> / Volume	0,05018



## YASEMİN

Aplik  
Wall Lamp

Ürün Kodu / Product Code  
001 038 090101 00 00



CLASS I IP20

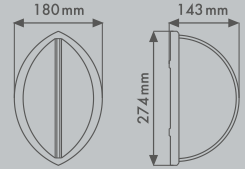

E27 MAX. 1x60W - 230 V ~ 50 Hz

Ambalaj Şekli / Package Type	Kutu / Pack	Ağırlık / Weight	12,00 Kg
Adet / Quantity	24	m <sup>3</sup> / Volume	0,08456

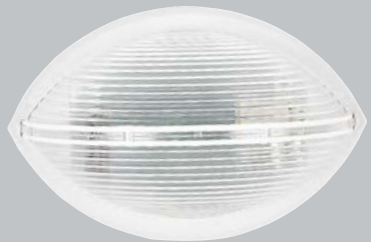

## YASEMİN

Oval Tavan Armatürü  
Oval Lighting Fixture

Ürün Kodu / Product Code  
001 038 080101 00 00



CLASS I IP20

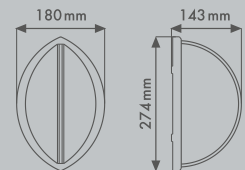

E27 MAX. 1x60W - 230 V ~ 50 Hz



Ambalaj Şekli / Package Type	Kutu / Pack	Ağırlık / Weight	12,00 Kg
Adet / Quantity	24	m <sup>3</sup> / Volume	0,08456



## FULYA

Tavan Armatürü  
Ceiling Lighting Fixture

Ürün Kodu / Product Code  
001 038 020101 00 00

  CLASS II IP20 

E27 MAX. 1x75W - 230 V ~ 50 Hz

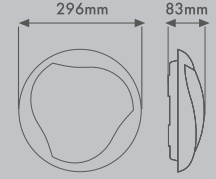

Ambalaj Şekli / Package Type	Kutu / Pack	Ağırlık / Weight	3,40 Kg
Adet / Quantity	5	m <sup>3</sup> / Volume	0,03915



## AKASYA

Tavan Armatürü  
Ceiling Lighting Fixture

Ürün Kodu / Product Code  
001 038 180101 00 00

  CLASS II IP20 

E27 MAX. 1x60W - 230 V ~ 50 Hz

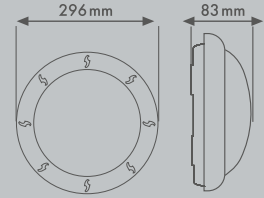

Ambalaj Şekli / Package Type	Kutu / Pack	Ağırlık / Weight	3,40 Kg
Adet / Quantity	5	m <sup>3</sup> / Volume	0,03915



## KAMELYA

Tavan Armatürü  
Ceiling Lighting Fixture

Ürün Kodu / Product Code  
001 038 170101 00 00

  CLASS II IP54 

E27 MAX. 1x60W - 230 V ~ 50 Hz

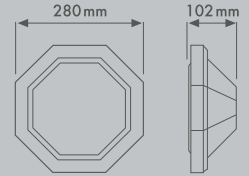

Ambalaj Şekli / Package Type	Kutu / Pack	Ağırlık / Weight	2,50 Kg
Adet / Quantity	5	m <sup>3</sup> / Volume	0,02078



## MERVE

Tavan Armatürü  
Ceiling Lighting Fixture

Ürün Kodu / Product Code  
001 038 110101 00 00

  CLASS II IP20 

E27 MAX. 1x60W - 230 V ~ 50 Hz

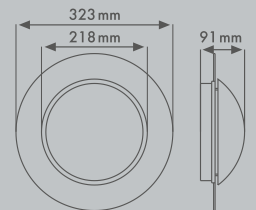

Ambalaj Şekli / Package Type	Kutu / Pack	Ağırlık / Weight	3,40 Kg
Adet / Quantity	5	m <sup>3</sup> / Volume	0,05227



## PİRAMİT

Aplik  
Wall Lamp

Ürün Kodu / Product Code  
001 038 190201 00 00



CLASS I IP20

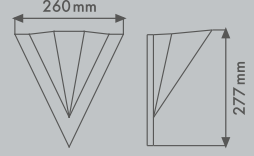

E27 MAX. 1x60W - 230 V ~ 50 Hz

Ambalaj Şekli / Package Type	Kutu / Pack	Ağırlık / Weight	9,00 Kg
Adet / Quantity	24	m <sup>3</sup> / Volume	0,08165



## KRALIÇE

Duvar Aplik  
Queen Wall Lamp

Ürün Kodu / Product Code  
016 038 250013



E27 MAX. 1x60W - 230 V ~ 50 Hz IP20

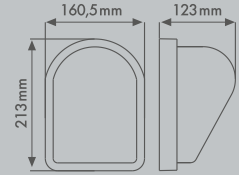

Ambalaj Şekli / Package Type	Kutu / Pack	Ağırlık / Weight	17,52 Kg
Adet / Quantity	48	m <sup>3</sup> / Volume	0,13915



## MANOLYA

Tavan Armatürü  
Ceiling Lighting Fixture

Ürün Kodu / Product Code  
001 038 010101 00 00



CLASS II IP20

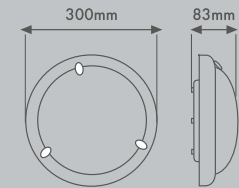

E27 MAX. 1x75W - 230 V ~ 50 Hz

Ambalaj Şekli / Package Type	Kutu / Pack	Ağırlık / Weight	2,60 Kg
Adet / Quantity	5	m <sup>3</sup> / Volume	0,03915



**SADE****Hazır Askı Tij Takımı**  
Lamp Holder and Hanging Set

Ürün Kodu / Product Code  
001 038 250018 00 00

E27

Ambalaj Şekli / Package Type	Kutu / Pack
Adet / m / Quantity / m	500
Ağırlık / Weight	37.62 kg
m <sup>3</sup> / Volume	0.131

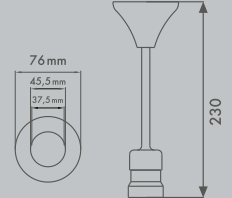
**PAPATYA****Askı Tij Takımı**  
Lamp Holder and Hanging Set

Ürün Kodu / Product Code  
001 038 250016 00 00

E27

Ambalaj Şekli / Package Type	Kutu / Pack
Adet / m / Quantity / m	250
Ağırlık / Weight	24.25 kg
m <sup>3</sup> / Volume	0.131

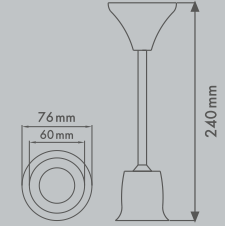
**PAPATYA****Büyük Askı Tij Takımı**  
Lamp Holder and Hanging Set Big

Ürün Kodu / Product Code  
001 038 250017 00 00

E27

Ambalaj Şekli / Package Type	Kutu / Pack
Adet / m / Quantity / m	80
Ağırlık / Weight	11.20 kg
m <sup>3</sup> / Volume	0.131

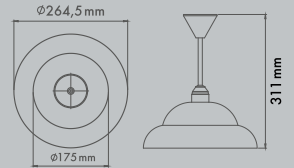



## AQUA

Nemliyer Waterproff

Kafesli Aplik Armatür Beyaz  
Wall Fixture Antigron White

Ürün Kodu / Product Code  
016 038 411100

CLASS II

IP 54

MAX. 26 W

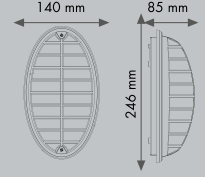

Ambalaj Şekli / Package Type	Kutu / Pack	Ağırlık / Weight	6.27 kg.
Adet / m / Quantity / m	20	m <sup>3</sup> / Volume	0.066



## AQUA

Nemliyer Waterproff

Kafesli Aplik Armatür Siyah  
Wall Fixture Antigron Black

Ürün Kodu / Product Code  
016 038 411111

CLASS II

IP 54

MAX. 26 W

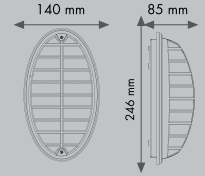

Ambalaj Şekli / Package Type	Kutu / Pack	Ağırlık / Weight	6.27 kg.
Adet / m / Quantity / m	20	m <sup>3</sup> / Volume	0.066



## OPAK

Kafesli Armatür Beyaz  
Fixture Antigron White

Ürün Kodu / Product Code  
016 038 411300

CLASS II

IP 54

MAX. 26 W

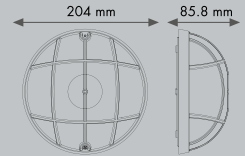

Ambalaj Şekli / Package Type	Kutu / Pack	Ağırlık / Weight	6.48 kg.
Adet / m / Quantity / m	24	m <sup>3</sup> / Volume	0.091



## OPAK

Kafesli Armatür Siyah  
Fixture Antigron Black

Ürün Kodu / Product Code  
016 038 411311

CLASS II

IP 54

MAX. 26 W

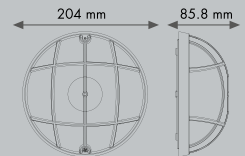

Ambalaj Şekli / Package Type	Kutu / Pack	Ağırlık / Weight	6.48 kg.
Adet / m / Quantity / m	24	m <sup>3</sup> / Volume	0.091

**ELİPS**Opal Armatür Beyaz  
Opal Lighting Fixture White

Ürün Kodu / Product Code  
016 038 410600

CE CLASS II

IP 65

MAX. 26 W

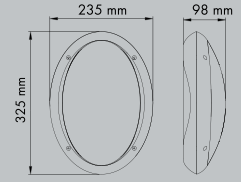

Ambalaj Şekli / Package Type	Kutu / Pack	Ağırlık / Weight	9,54 Kg
Adet / Quantity	10	m <sup>3</sup> / Volume	0,08200

**ELİPS**Opal Armatür Siyah  
Opal Lighting Fixture Black

Ürün Kodu / Product Code  
016 038 410611

CE CLASS II

IP 65

MAX. 26 W

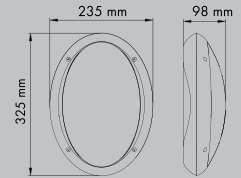

Ambalaj Şekli / Package Type	Kutu / Pack	Ağırlık / Weight	9,54 Kg
Adet / Quantity	10	m <sup>3</sup> / Volume	0,08200

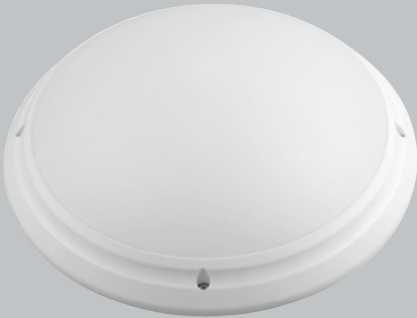
**OPAL**Armatür Beyaz  
Lighting Fixture White

Ürün Kodu / Product Code  
016 038 410500

CE CLASS II

IP 65

MAX. 26 W

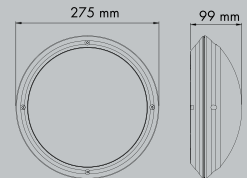

Ambalaj Şekli / Package Type	Kutu / Pack	Ağırlık / Weight	7,57 Kg
Adet / Quantity	10	m <sup>3</sup> / Volume	0,08100

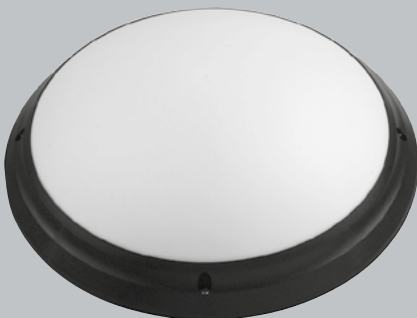
**OPAL**Armatür Siyah  
Lighting Fixture Black

Ürün Kodu / Product Code  
016 038 410511

CE CLASS II

IP 65

MAX. 26 W

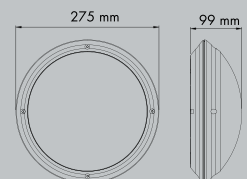

Ambalaj Şekli / Package Type	Kutu / Pack	Ağırlık / Weight	7,57 Kg
Adet / Quantity	10	m <sup>3</sup> / Volume	0,08100



## DOLUNAY

Opak Armatür Beyaz  
Opak Lighting Fixture White

Ürün Kodu / Product Code  
016 038 700100

CE CLASS II

IP 54

MAX. 26 W

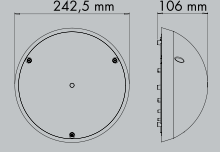

Ambalaj Şekli / Package Type	Kutu / Pack	Ağırlık / Weight	12,11 Kg
Adet / Quantity	16	m <sup>3</sup> /Volume	0,10080



## DOLUNAY

Opak Armatür Siyah  
Opak Lighting Fixture Black

Ürün Kodu / Product Code  
016 038 700111

CE CLASS II

IP 54

MAX. 26 W

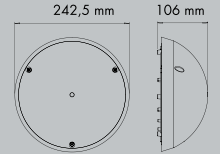

Ambalaj Şekli / Package Type	Kutu / Pack	Ağırlık / Weight	12,11 Kg
Adet / Quantity	16	m <sup>3</sup> /Volume	0,10080

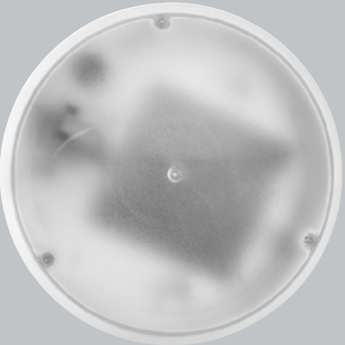

## DOLUNAY

Şeffaf Armatür Beyaz  
Transparent Lighting Fixture White

Ürün Kodu / Product Code  
016 038 700200

CE CLASS II

IP 54

MAX. 26 W

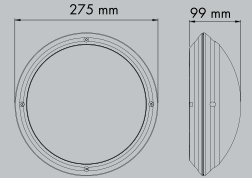

Ambalaj Şekli / Package Type	Kutu / Pack	Ağırlık / Weight	12,11 Kg
Adet / Quantity	16	m <sup>3</sup> /Volume	0,10080



## DOLUNAY

Şeffaf Armatür Siyah  
Transparent Lighting Fixture Black

Ürün Kodu / Product Code  
016 038 700211

CE CLASS II

IP 54

MAX. 26 W

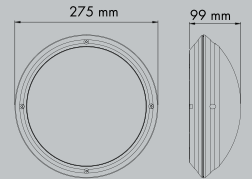

Ambalaj Şekli / Package Type	Kutu / Pack	Ağırlık / Weight	12,11 Kg
Adet / Quantity	16	m <sup>3</sup> /Volume	0,10080

**DOLUNAY**Opak Aplik Beyaz  
Opak Wall Lamp WhiteÜrün Kodu / Product Code  
016 038 700300

MAX. 26 W

IP 54

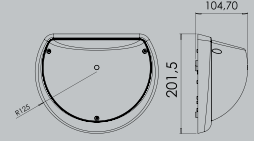

Ambalaj Şekli / Package Type	Kutu / Pack	Ağırlık / Weight	15,14 Kg
Adet / Quantity	20	m <sup>3</sup> / Volume	0,11000

**DOLUNAY**Opak Aplik Siyah  
Opak Wall Lamp BlackÜrün Kodu / Product Code  
016 038 700311

MAX. 26 W

IP 54

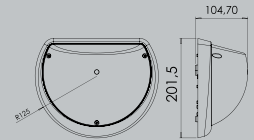

Ambalaj Şekli / Package Type	Kutu / Pack	Ağırlık / Weight	15,14 Kg
Adet / Quantity	20	m <sup>3</sup> / Volume	0,11000

**DOLUNAY**Şeffaf Armatür Beyaz  
Transparant Lighting Fixture WhiteÜrün Kodu / Product Code  
016 038 700400

MAX. 26 W

IP 54

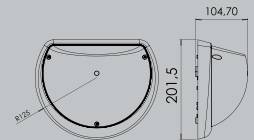

Ambalaj Şekli / Package Type	Kutu / Pack	Ağırlık / Weight	15,14 Kg
Adet / Quantity	20	m <sup>3</sup> / Volume	0,11000

**DOLUNAY**Şeffaf Armatür Siyah  
Transparant Lighting Fixture BlackÜrün Kodu / Product Code  
016 038 700411

MAX. 26 W

IP 54

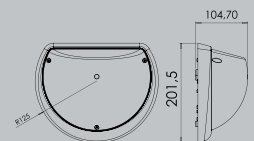

Ambalaj Şekli / Package Type	Kutu / Pack	Ağırlık / Weight	15,14 Kg
Adet / Quantity	20	m <sup>3</sup> / Volume	0,11000

**OPAK**Armatür Beyaz  
Lighting Fixture WhiteÜrün Kodu / Product Code  
016 038 410800

MAX. 26 W

CE IP 54

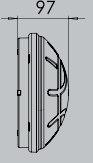
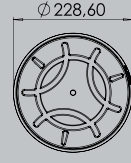

Ambalaj Şekli / Package Type	Kutu / Pack	Ağırlık / Weight	6,31 Kg
Adet / Quantity	16	m <sup>3</sup> /Volume	0,08464

**OPAK**Armatür Siyah  
Lighting Fixture BlackÜrün Kodu / Product Code  
016 038 410811

MAX. 26 W

CE IP 54

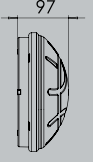
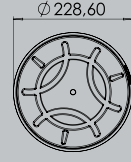

Ambalaj Şekli / Package Type	Kutu / Pack	Ağırlık / Weight	6,31 Kg
Adet / Quantity	16	m <sup>3</sup> /Volume	0,08464

**360°**Hareket Sensörlü Glob Armatür  
Sensor Globe Lighting FixtureÜrün Kodu / Product Code  
001 038 250022 00 00

E27 MAX. 2x25W - 230 V ~ 50 Hz IP20

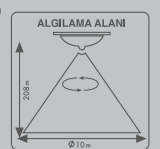
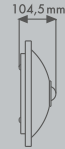

Ambalaj Şekli / Package Type	Kutu / Pack	Ağırlık / Weight	12,55 Kg
Adet / Quantity	10	m <sup>3</sup> /Volume	0,12900

**SENSÖR**E27 Duyulu Duvar Aplik  
E27 Lamp Holder Wall LampÜrün Kodu / Product Code  
078 039 500100

E27 MAX. 2x25W - 230 V ~ 50 Hz IP20

Ambalaj Şekli / Package Type	Kutu / Pack	Ağırlık / Weight	7,80 Kg
Adet / Quantity	10	m <sup>3</sup> /Volume	0,05800



## FLORA

Bahçe Armatürü  
Garden Light

Ürün Kodu / Product Code

016 038 010116 Siyah / Black

016 038 020116 Beyaz / White

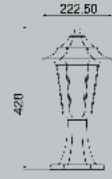

Ambalaj Şekli / Package Type	Kutu / Pack	Ağırlık / Weight	6,42 Kg
Adet / Quantity	12	m <sup>3</sup> / Volume	0,1299



## FLORA

Aplik  
Wall Lamp

Ürün Kodu / Product Code

016 038 010117 Siyah / Black

016 038 020117 Beyaz / White

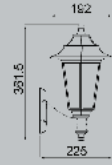

Ambalaj Şekli / Package Type	Kutu / Pack	Ağırlık / Weight	6,51 Kg
Adet / Quantity	12	m <sup>3</sup> / Volume	0,1299



## FLORA

Tavan Tipi  
Ceiling Type

Ürün Kodu / Product Code

016 038 412011 Siyah / Black

016 038 412000 Beyaz / White

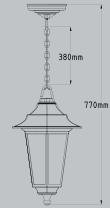

Ambalaj Şekli / Package Type	Kutu / Pack	Ağırlık / Weight	6,16 Kg
Adet / Quantity	12	m <sup>3</sup> / Volume	0,1178



## FLORA

Yarım Aplik  
Bracket

Ürün Kodu / Product Code

016 038 412111 Siyah / Black

016 038 412100 Beyaz / White

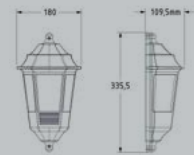

Ambalaj Şekli / Package Type	Kutu / Pack	Ağırlık / Weight	7,42 Kg
Adet / Quantity	20	m <sup>3</sup> / Volume	0,1253

## GARDEN

Yer Aydınlatma  
Floor Lighting



Ürün Kodu / Product Code  
016 038 010118 Siyah / Black  
016 038 010119 Beyaz / White

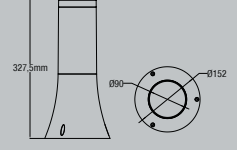

Ambalaj Şekli / Package Type	Kutu / Pack	Ağırlık / Weight	4,630 Kg
Adet / Quantity	12	m <sup>3</sup> / Volume	0,097

## GARDEN

Uzun Yer Aydınlatma  
Long Floor Lighting



Ürün Kodu / Product Code  
016 038 010120 Siyah / Black  
016 038 010121 Beyaz / White

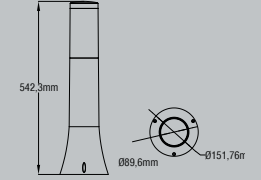

Ambalaj Şekli / Package Type	Kutu / Pack	Ağırlık / Weight	4,260 Kg
Adet / Quantity	8	m <sup>3</sup> / Volume	0,1029

## GARDEN

Duvar Aydınlatma  
Wall Lighting

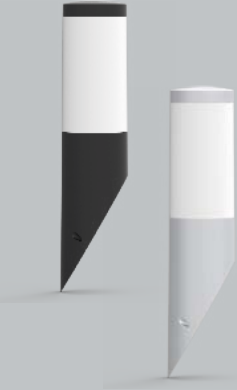

Ürün Kodu / Product Code  
016 038 010122 Siyah / Black  
016 038 010123 Beyaz / White

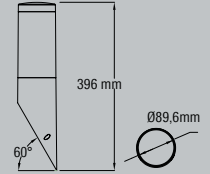

Ambalaj Şekli / Package Type	Kutu / Pack	Ağırlık / Weight	6,900 Kg
Adet / Quantity	20	m <sup>3</sup> / Volume	0,0542

## GARDEN

Aplik  
Bracket



Ürün Kodu / Product Code  
016 038 010124 Siyah / Black  
016 038 010125 Beyaz / White

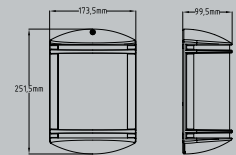

Ambalaj Şekli / Package Type	Kutu / Pack	Ağırlık / Weight	8,300 Kg
Adet / Quantity	16	m <sup>3</sup> / Volume	0,0723



## EXIT - ACİL AYDINLATMA ARMATÜRLERİ (LEDLİ) IP20

## FOSFORLU SERİ ACİL AYDINLATMA ARMATÜRÜ



102 038 0008XX - CEXA

\*GÖVDE : ABS

\*CAM : Polistren (PS) isteğe bağlı Akrilik(PMMA) veya Policarbon(PC)

\*BASKI : Akrilik Işık geçirgen Translucent Folyo

\*ÇALIŞMA : Acil de ve Şebeke de sürekli çalışma

\*PİL : 3.6V 80mAH NiMH (NikelMethalhidrid)

\*ŞARJ SÜRESİ : 14-20 Saat

\*DEŞARJ SÜRESİ : 60 Dk veya isteğe bağlı 180 Dk

\*KORUMA SINIFI : IP20

\*LED : 4.8mm 6000K Beyaz Mantar Led

veya 2835 6400K EDİSON OPTO SMD Led

TÜKETİM : 2 Watt

CE

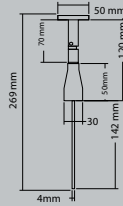
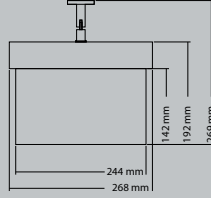

102 038 0009XX - CEXA-FS

\* ABS gövde

\* Kristal (PS) cam (İsteğe bağlı Akrilik (PMMA) ve Policarbon (PC) cam

\* 100 micron akrilik fosfor blok







































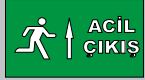

























\* 0.40 Akrilik Phosphor Folyo

\* 2-4 saat Fosfor ışık yansımaları (İsteğe bağlı 4-6 saat/6-8 saat/8-12 saat)

\* Işık depolama uygun ışık yoğunluğunun sa 6-8 saat

\* Sudan ve Nemden etkilenmez

\* IP65

							
01	02	03	04	05	06	07	08
							
09	10	11	12	13	14		
							
15	16	17	18	19	20		
							
21	22	23	24	25	26		
							
27	28	29	30	31	32		
							
33	34	35	36				
							
37	38	39	40	41	42	43	
							
44	45	46	47	48	49	50	51
							
52	53	54	55	56	57	58	59
							
60	61	62	63	64	65		

**NOTE :**

A series of horizontal dotted lines for writing notes.



### **Mutlusan Plastik Elektrik San ve Tic. A.Ş.**

İkitelli Org.San. Bölgesi Mahallesi Enkoop Cad.  
No:7 Başakşehir- İstanbul  
Tel : +90 (212) 485 05 44 (PBX)  
Fax: +90 (212) 485 10 12

### **Karaköy Şube**

Okcumusa Cad. Güneşhan İş Hanı No : 24/10  
Karaköy-İstanbul  
Tel : +90 (212) 237 06 02 (PBX)  
Fax: +90 (212) 237 77 47

### **Perpa Şube**

Perpa Tic. Merkezi A Blok Kat: 2  
No: 9-009 Okmeydanı - İstanbul  
Tel : +90 (212) 320 05 78 (PBX)  
Fax: +90 (212) 320 05 81



[mutlusan.com.tr](http://mutlusan.com.tr)